

*konusulan
the spoken kalite...
quality...*

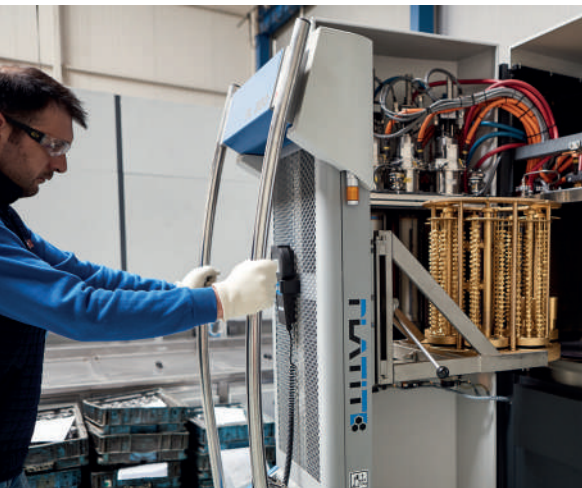



TS EN ISO 9001:2015





AKKO Makina Sanayi ve Ticaret A.Ş, fondata da Abdullah KARAKUŞ nel 1986, produce portautensili per tornitura, filettatura e scanalatura, punte ad inserto intercambiabile, corpi fresa ad inserto e utensili a marchio privato. Produciamo circa 10.000 tipi di utensili standard a catalogo e abbiamo una capacità produttiva annua di 400.000 pezzi su un'area di circa 39.000 mq. Al mondo siamo rappresentati in 90 paesi, europei, asiatici, africani, sudamericani, paesi nordamericani e paesi del Medio Oriente. Le nostra scorta di magazzino contiene una media di 300.000 pezzi mentre la materia prima (acciaio) viene appositamente prodotta seguendo i nostri standard. Il nostro sistema di produzione è integrato per cui oltre alla lavorazione meccanica di fresatura e rettifica, eseguiamo il trattamento termico e il rivestimento. AKKO detiene il primato mondiale di produzione di utensii ad inserto intercambiabile.

We as AKKO Makina Sanayi ve Ticaret A.Ş, which has been founded by Abdullah KARAKUŞ in 1986, produces Turning Tool Holders, Threading and Grooving Tool Holders, U-Drills, Milling Tool Holders, and Precision Tool Holders (OEM Tool Holders) on-demand. We produce standard 10.000 kinds of tool holders with a production capacity of 400.000 pieces per annum in an area of about 39.000 square meters. We are going on exporting to 90 countries including European, Asian, African, South American Countries, North American Countries, and Middle East Countries. We keep ready about 300.000 pieces produced products in our stock. Steel Raw materials that we make produced especially for us are delivered our factory and all production process are made in our factory. All kinds of operations from machining of steel to heat treatment and coating on our tools are made in our integrated factory AKKO.

AKKO - ведущий производитель резцов, фрез и свёрл со сменными пластинами. Державки и оправки изготовлены для использования унифицированных пластин (ИСО), а также специальных пластин ведущих мировых производителей. Весь инструмент, который производит компания АККО, имеет очень высокое качество и оснащается продукцией Швейцарского производства. Высокое качество продукции обеспечивается современным оборудованием с ЧПУ, высокой культурой производства и использованием высококачественных материалов. Компания основана Абдуллах Каракусом в 1986 году и находится в Турции, с площадью 39.000 м² в городе Конья. Производственная программа: державки токарные, в том числе с хвостовиком из твёрдого сплава; корпуса фрез со сменными пластинами современных конструкций; корпуса свёрл со сменными пластинами. АККО предлагает более 10.000 стандартных видов инструментов, ежегодно изготавливая и поставляя клиентам свыше 400.000 изделий. На складе размещено около 300.000 инструментов, что позволяет удовлетворить любой запрос заказчика. Компания экспортирует свою продукцию в 90 стран мира, включая континент Европы, Азии, Африки, Южной Америки и Ближнего Востока

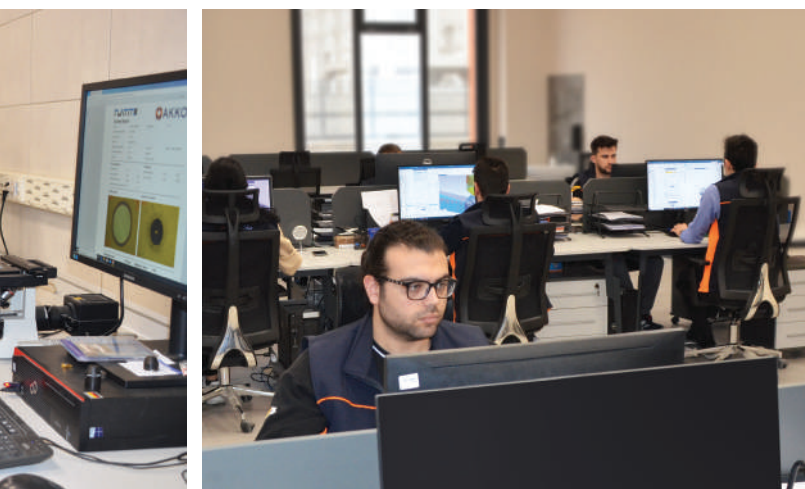

DIŞ TORNA TAKIMLARI	
S11 S12-S28 S29-S31 S32-S43 S44-S50 S51-S65 S66-S70 S70-S73	DIŞ TORNA KATERLERİ KODLAMA SİSTEMİ T-SİSTEM DIŞ TORNA KATERLERİ M-SİSTEM DIŞ TORNA KATERLERİ P-SİSTEM DIŞ TORNA KATERLERİ C-SİSTEM DIŞ TORNA KATERLERİ S-SİSTEM DIŞ TORNA KATERLERİ S-SİSTEM İSVİÇRE TİPİ KAYAR OTOMAT MAKİNA TAKIMLARI KOLAY DEĞİŞTİRİLEBİLİR İSVİÇRE TİPİ KAYAR OTOMAT MAKİNA TAKIMLARI
DELİK TORNA TAKIMLARI	
S75 S76-S82 S83-S87 S88-S94 S95-S112	DELİK TORNA KATERLERİ KODLAMA SİSTEMİ T&C SİSTEM DELİK TORNA KATERLERİ M-SİSTEM DELİK TORNA KATERLERİ P-SİSTEM DELİK TORNA KATERLERİ S-SİSTEM DELİK TORNA KATERLERİ
TIRLAMAZ TAKIMLAR-ANTI VIBRATION TOOLS	
S114 S115-S120	TIRLAMAZ TAKIMLARIN KODLAMA SİSTEMİ TIRLAMAZ TAKIMLAR
KARTUŞLAR	
S122 S123-S125 S125-S128 S128-S131	KARTUŞLARIN KODLAMA SİSTEMİ S-TİP RÊKTEFİYE KARTUŞLARI S-SİSTEM KARTUŞLAR P-SİSTEM KARTUŞLAR VE BORU PAHLAMA TAKIMLARI
DIŞ AÇMA TAKIMLARI	
S133 S134-S139	DIŞ AÇMA KATERLERİ KODLAMA SİSTEMİ DIŞ AÇMA KATERLERİ ve TEKNİK BİLGİ
KANAL AÇMA TAKIMLARI	
S141 S142-S157 S158-S161 S162-S165 S165 S166-S169 S170 S173-S183	KANAL KATERLERİ KODLAMA SİSTEMİ DIŞ ÇAP KANAL AÇMA TAKIMLARI DIŞ ÇAP KANAL AÇMA İSVEÇ TİPİ KAYAR OTOMAT MAKİNA TAKIMLARI DIŞ ÇAP ALIN KANAL AÇMA TAKIMLARI L TİP ALIN KANAL AÇMA TAKIMLARI KESME VE DERİN KANAL AÇMA LAMALARI KESME VE DERİN KANAL AÇMA LAMA BLOĞU DELİK İÇİ KANAL KATERLERİ
DELİK DELME ve İŞLEME TAKIMLARI	
S187-S216 S218-S219 S220 S221 S222-S224 S225-S234	TAKMA UÇLU MATKAPLAR ve KODLAMA SİSTEMİ DELİK PAHLAMA TAKIMI VE MONTAJ ŞEKLİ EKSANTRİK TAKMA UÇLU MATKAP ADAPTÖRÜ ÖZEL DELİK DELME ve İŞLEME TAKIMI SİPARİŞ FORMU EKONOMİK KEŞİCİLER ve KODLAMA SİSTEMİ AYARLI DELİK İŞLEME BARALARI ve KODLAMA SİSTEMİ
FREZELEME TAKIMLARI	
S236 S237-S238 S238 S239 S240-S266 S267-S270 S270-S281 S281-S293 S293-S303 S304-S305 S306-S307 S308 S308-S310 S310-S311 S312-S351 S352-S356 S357-S359 S360-S368 S369-S370 S371-S372 S374-S378	FREZELEME TAKIMLARI KODLAMA SİSTEMİ S-SİSTEM PAH FREZELER HELİS PAH FREZELEME TAKIMLARI SİLİNDİRİK ALYAN BAŞLI VİDA (DIN 974-1) HAVŞALARINI AÇMA FREZELERİ S-SİSTEM YÜZEY PARMAK FREZELER S-SİSTEM YÜZEY ve KOPYA PARMAK FREZELER S-SİSTEM HIZLI İLERLEMELİ PARMAK FREZELER S-SİSTEM MODÜLER PARMAK FREZELER S-SİSTEM HIZLI İLERLEMELİ MODÜLER PARMAK FREZELER KÜRE UÇLU PARMAK FREZELER MODÜLER KÜRE UÇLU PARMAK FREZELER VIDALI TAKIM TUTUCULARI DIŞ AÇMA FREZELEME TAKIMLARI S-SİSTEM HELİS FREZELER YÜZEY FREZELER YÜZEY ve KOPYA FREZELER C-SİSTEM YÜZEY FREZELER HIZLI İLERLEMELİ FREZELER T KANAL FREZELER DİSK FREZELER FREZELEME TAKIMLARI MONTAJ ÖLÇÜLERİ ve TEKNİK BİLGİLER
YEDEK PARÇALAR	
S380-S393 S394-S399	YEDEK PARÇALAR ÜRÜN GURUPLARINA GÖRE İÇİNDEKİLER

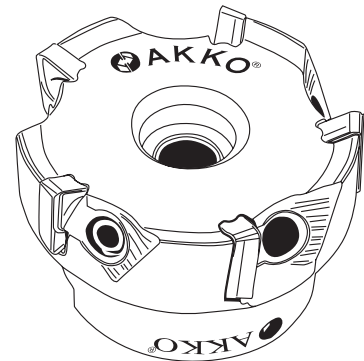
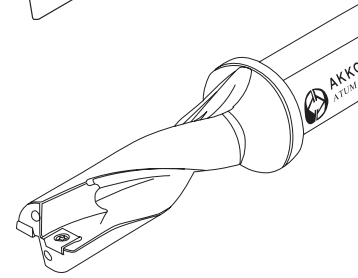
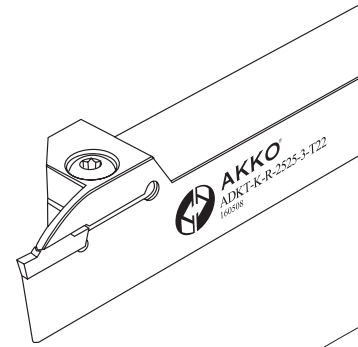
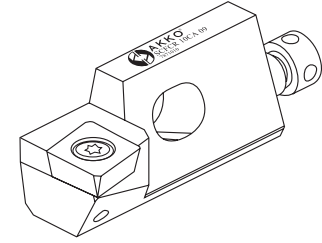
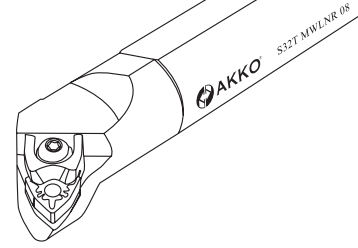
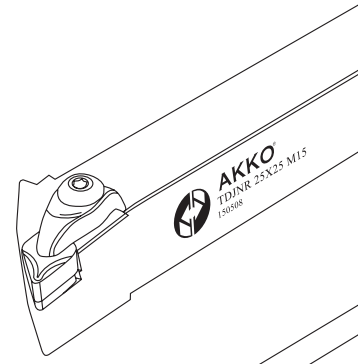

CONTENTS

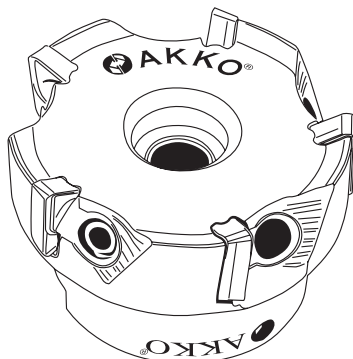
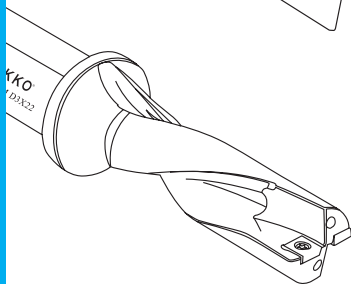
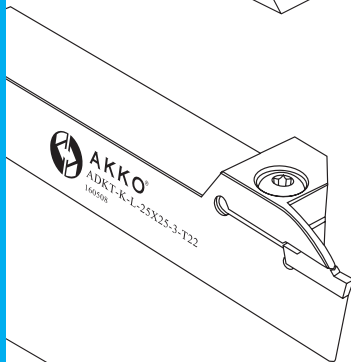
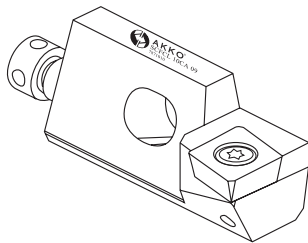
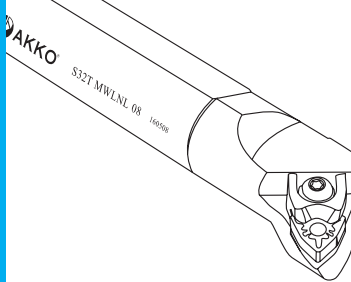
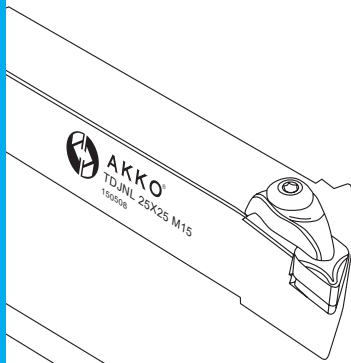

EXTERNAL TURNING TOOLHOLDERS

EXTERNAL TURNING TOOLHOLDERS DESIGNATION SYSTEM
 T-SYSTEM EXTERNAL TURNING TOOLHOLDERS
 M-SYSTEM EXTERNAL TURNING TOOLHOLDERS
 P-SYSTEM EXTERNAL TURNING TOOLHOLDERS
 C-SYSTEM EXTERNAL TURNING TOOLHOLDERS
 S-SYSTEM EXTERNAL TURNING TOOLHOLDERS
 S-SYSTEM TOOLS FOR SWISS TYPE SLIDING AUTOMATIC LATHES
 SEC TOOLS - SWISS EASY CHANGE

P11
 P12-P28
 P29-P31
 P32-P43
 P44-P50
 P51-P65
 P66-P70
 P70-P73

INTERNAL TURNING TOOLHOLDERS

BORING BARS DESIGNATION SYSTEM
 T&C SYSTEM BORING BARS
 M-SYSTEM BORING BARS
 P-SYSTEM BORING BARS
 S-SYSTEM BORING BARS

P75
 P76-P82
 P83-P87
 P88-P94
 P95-P112

ANTIVIBRATION TOOLS

ANTIVIBRATION TOOL DESIGNATION SYSTEM
 ANTIVIBRATION TOOLS

P114
 P115-P120

CARTRIDGE

CARTRIDGE DESIGNATION SYSTEM
 S-TYPE ENGINE OVERHAUL CARTRIDGE
 S-SYSTEM CARTRIDGE
 P-SYSTEM CARTRIDGE AND PIPE BEVELING and CHAMFERING TOOLS

P122
 P123-P125
 P125-P128
 P128-P131

THREADING TOOLHOLDERS

THREADING TOOLHOLDERS DESIGNATION SYSTEM
 THREADING TOOLHOLDERS and TECHNICAL INFORMATION

P133
 P134-P139

GROOVING TOOLHOLDERS

GROOVING TOOLHOLDERS DESIGNATION SYSTEM
 EXTERNAL GROOVING TOOLHOLDERS
 EXTERNAL GROOVING TOOLHOLDERS FOR SWISS TYPE SLIDING AUTOMATIC LATHES
 FACE EXTERNAL GROOVING TOOLHOLDERS
 L TYPE FACE EXTERNAL GROOVING TOOLHOLDERS
 BLADES FOR PARTING AND DEEP GROOVING
 BLOCKS FOR PARTING AND DEEP GROOVING BLADES
 INTERNAL GROOVING TOOLHOLDERS

P141
 P142-P157
 P158-P161
 P162-P165
 P165
 P166-P169
 P170
 P173-P183

DRILLING and HOLEMAKING TOOLS

U-DRILL SYSTEM and DESIGNATION SYSTEM
 DRILL CHAMFERING RING TOOLS and MOUNTING SYSTEM
 EXCENTRIC ADAPTOR FOR U-DRILLS
 SPECIAL DRILL ORDER FORM
 ECONOMIC CUTTING TOOLS and DESIGNATION SYSTEM
 ADJUSTABLE BORING HEADS and DESIGNATION SYSTEM

P187-P216
 P218-P219
 P220
 P221
 P222-P224
 P225-P234

MILLING TOOLS

MILLING TOOLS DESIGNATION SYSTEM
 S-SYSTEM CHAMFERING END MILLS
 HELIX CHAMFER MILLING TOOLS
 COUNTERSINK MILLING TOOL FOR CYLINDRICAL ALLEN HEAD SCREWS (DIN 974-1)
 S-SYSTEM END MILLS
 S-SYSTEM FACE and COPY END MILLS
 S-SYSTEM HIGHFEED END MILLS
 S-SYSTEM MODULAR END MILLS (SCREW TYPE TOOLS)
 S-SYSTEM MODULAR (SCREW TYPE) HIGHFEED END MILLS
 BALL NOSE MILLS
 BALL NOSE MODULAR (SCREW TYPE) END MILLS
 SCREWED TOOL HOLDERS
 THREAD MILLING TOOLS
 S-SYSTEM HELIX END MILL
 FACE MILLING
 FACE and COPY MILLING TOOLS
 C-SYSTEM FACE MILLING
 HIGH FEED MILLING TOOLS
 T SLOT MILLING
 DISC MILLING
 MOUNTING REFERENCE FOR MILLING CUTTERS and TECHNICAL INFORMATION

P236
 P237-P238
 P238
 P239
 P240-P266
 P267-P270
 P270-P281
 P281-P293
 P293-P303
 P304-P305
 P306-P307
 P308
 P308-P310
 P310-P311
 P312-P351
 P352-P356
 P357-P359
 P360-P368
 P369-P370
 P371-P372
 P374-P378

SPARE PARTS

SPARE PARTS
 INDEX

P380-P393
 P394-P399

	ДЕРЖАВКИ ДЛЯ НАРУЖНОГО ТОЧЕНИЯ
C11 C12-C28 C29-C31 C32-C43 C44-C50 C51-C65 C66-C70 C70-C73	ОБОЗНАЧЕНИЕ ДЕРЖАВОК ДЛЯ НАРУЖНОГО ТОЧЕНИЯ ПО ISO Т-ТИП ДЕРЖАВКИ ДЛЯ НАРУЖНОГО ТОЧЕНИЯ М-ТИП ДЕРЖАВКИ ДЛЯ НАРУЖНОГО ТОЧЕНИЯ Р-ТИП ДЕРЖАВКИ ДЛЯ НАРУЖНОГО ТОЧЕНИЯ С-ТИП ДЕРЖАВКИ ДЛЯ НАРУЖНОГО ТОЧЕНИЯ S-ТИП ДЕРЖАВКИ ДЛЯ НАРУЖНОГО ТОЧЕНИЯ S-ТИП ДЕРЖАВКИ ДЛЯ ШВЕЙЦАРСКИХ СТАНКОВ АВТОМАТОВ ДЕРЖАВКИ ДЛЯ СМЕННЫХ ГОЛОВОК
	РАСТОЧНЫЕ ДЕРЖАВКИ
C75 C76-C82 C83-C87 C88-C94 C95-C112	СИСТЕМА ОБОЗНАЧЕНИЯ РАСТОЧНЫХ ДЕРЖАВОК ПО ISO Т И С-ТИП РАСТОЧНЫЕ ДЕРЖАВКИ М-ТИП РАСТОЧНЫЕ ДЕРЖАВКИ Р-ТИП РАСТОЧНЫЕ ДЕРЖАВКИ S-ТИП РАСТОЧНЫЕ ДЕРЖАВКИ
	АНТИВИБРАЦИОННЫЕ ДЕРЖАВКИ
C114 C115-C120	СИСТЕМА ОБОЗНАЧЕНИЙ АНТИВИБРАЦИОННЫХ ДЕРЖАВОК АНТИВИБРАЦИОННАЯ ДЕРЖАВКА
	КАРТРИДЖИ
C122 C123-C125 C125-C128 C128-C131	СИСТЕМА ОБОЗНАЧЕНИЯ КАРТРИДЖЕЙ ТИП-S ХОНИНГОВАЛЬНЫЕ КАРТРИДЖИ (ДЛЯ РЕМОНТА ДВС) S-ТИП КАРТРИДЖИ Р-ТИП КАРТРИДЖИ / ТОРЦОВОЧНАЯ ГОЛОВКА ДЛЯ ЦИЛИНДРИЧЕСКИХ ЗАГОТОВОК
	ДЕРЖАВКИ ДЛЯ НАРЕЗАНИЯ НАРУЖНОЙ РЕЗЬБЫ
C133 C134-C139	СИСТЕМА ОБОЗНАЧЕНИЯ ДЕРЖАВОК ДЛЯ НАРЕЗАНИЯ НАРУЖНОЙ РЕЗЬБЫ ДЕРЖАВКА ДЛЯ НАРЕЗАНИЯ НАРУЖНОЙ РЕЗЬБЫ / ТЕХНИЧЕСКИЕ РЕКОМЕНДАЦИИ ДЛЯ НАРЕЗАНИЯ РЕЗЬБЫ
	ДЕРЖАВКИ ДЛЯ ОБРАБОТКИ КАНАВОК
C141 C142-C157 C158-C161 C162-C165 C165 C166-C169 C170 C173-C183	СИСТЕМА ОБОЗНАЧЕНИЯ ДЕРЖАВОК ДЛЯ ОБРАБОТКИ КАНАВОК ДЕРЖАВКИ ДЛЯ ОБРАБОТКИ НАРУЖНЫХ КАНАВОК ДЕРЖАВКИ ДЛЯ ОБРАБОТКИ НАРУЖНЫХ КАНАВОК ДЛЯ ТОКАРНЫХ СТАНКОВ ШВЕЙЦАРСКОГО ТИПА ДЕРЖАВКИ ДЛЯ ОБРАБОТКИ ТОРЦЕВЫХ КАНАВОК ДЕРЖАВКИ L-ТИПА ДЛЯ ОБРАБОТКИ ТОРЦЕВЫХ КАНАВОК НОЖИ ДЛЯ ОТРЕЗКИ И ОБРАБОТКИ ГЛУБОКИХ КАНАВОК БЛОКИ К СМЕННЫМ НОЖАМ ДЛЯ ОТРЕЗКИ И ОБРАБОТКИ ГЛУБОКИХ КАНАВОК ДЕРЖАВКИ ДЛЯ ОБРАБОТКИ ВНУТРЕННИХ КАНАВОК
	ИНСТРУМЕНТ ДЛЯ СВЕРЛЕНИЯ И ОБРАБОТКИ ОТВЕРСТИЙ
C187-C216 C218-C219 C220 C221 C222-C224 C225-C234	СВЕРЛА /СИСТЕМА ОБОЗНАЧЕНИЯ СВЕРЕЛ КОЛЬЦА ДЛЯ СНЯТИЯ ФАСКИ / ЭКСЦЕНТРИЧЕСКИЙ АДАПТЕР ДЛЯ СВЕРЕЛ ЭКСЦЕНТРИЧЕСКИЙ АДАПТЕР ДЛЯ СВЕРЕЛ ФОРМА ДЛЯ ЗАКАЗА СПЕЦИАЛЬНЫХ СВЕРЕЛ МНОГОФУНКЦИОНАЛЬНЫЙ MULTI TOOL / СИСТЕМА ОБОЗНАЧЕНИЯ MULTI TOOL РЕГУЛИРУЕМЫЕ РАСТОЧНЫЕ ГОЛОВКИ / СИСТЕМА ОБОЗНАЧЕНИЙ РЕГУЛИРУЕМЫХ РАСТОЧНЫХ ГОЛОВОК
	ФРЕЗЕРНЫЙ ИНСТРУМЕНТ
C236 C237-C238 C238 C239 C240-C266 C267-C270 C270-C281 C281-C293 C293-C303 C304-C305 C306-C307 C308 C308-C310 C310-C311 C312-C351 C352-C356 C357-C359 C360-C368 C369-C370 C371-C372 C374-C378	СИСТЕМА ОБОЗНАЧЕНИЙ ФРЕЗЕРНОГО ИНСТРУМЕНТА S-ТИП КОНЦЕВЫЕ ФРЕЗЫ ДЛЯ СНЯТИЯ ФАСКИ (ЗЕНКОВКИ) КУКУРУЗНЫЕ ФРЕЗЫ ДЛЯ СНЯТИЯ ФАСКИ ЗЕНКОВКА ДЛЯ ОТВЕРСТИЙ ПОД ВИНТЫ С ЦИЛИНДРИЧЕСКОЙ И ШЕСТИГРАННОЙ ГОЛОВКОЙ (DIN 974-1) S-ТИП КОНЦЕВЫЕ ФРЕЗЫ S-ТИП КОНЦЕВЫЕ РАДИУСНЫЕ ФРЕЗЫ S-ТИП ВЫСОКОПРОИЗВОДИТЕЛЬНЫЕ КОНЦЕВЫЕ ФРЕЗЫ S-ТИП СМЕННЫЕ ФРЕЗЕРНЫЕ ГОЛОВКИ (КРЕПЛЕНИЕ ПОД РЕЗЬБУ) S-ТИП СМЕННЫЕ ФРЕЗЕРНЫЕ ГОЛОВКИ (КРЕПЛЕНИЕ ПОД РЕЗЬБУ) СФЕРИЧЕСКИЕ КОНЦЕВЫЕ ФРЕЗЫ S-ТИП СМЕННЫЕ СФЕРИЧЕСКИЕ ФРЕЗЕРНЫЕ ГОЛОВКИ (КРЕПЛЕНИЕ ПОД РЕЗЬБУ) ОПРАВКИ ДЛЯ СМЕННЫХ ГОЛОВОК РЕЗЬБОНАРЕЗНЫЕ ФРЕЗЫ S-ТИП СПИРАЛЬНАЯ КОНЦЕВАЯ ФРЕЗА (КУКУРУЗНАЯ ФРЕЗА) ТОРЦЕВЫЕ ФРЕЗЫ ТОРЦЕВЫЕ И КОПИРОВАЛЬНЫЕ ФРЕЗЫ С-ТИП ТОРЦЕВЫЕ ФРЕЗЫ ВЫСОКОПРОИЗВОДИТЕЛЬНЫЕ ТОРЦЕВЫЕ ФРЕЗЫ Т-ОБРАЗНЫЕ ФРЕЗЫ ДИСКОВЫЕ ТРЕХСТОРОННИЕ ФРЕЗЫ ИНСТРУКЦИЯ ПО УСТАНОВКЕ ФРЕЗ И ТЕХНИЧЕСКАЯ ИНФОРМАЦИЯ
	ЗАПАСТНЫЕ ЧАСТИ
C380-C393 C394-C399	ЗАПАСТНЫЕ ЧАСТИ СОДЕРЖАНИЕ

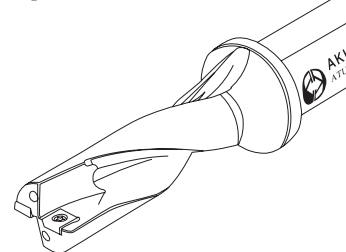
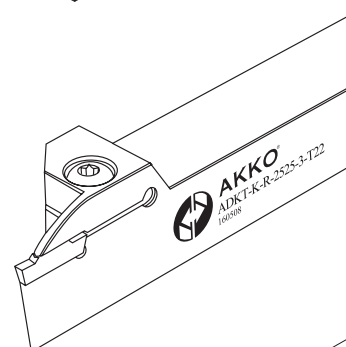
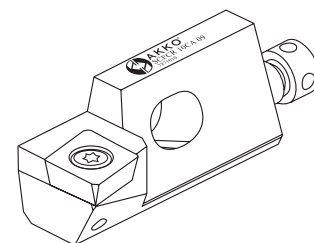
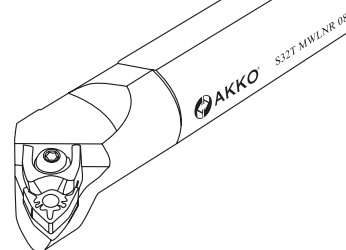
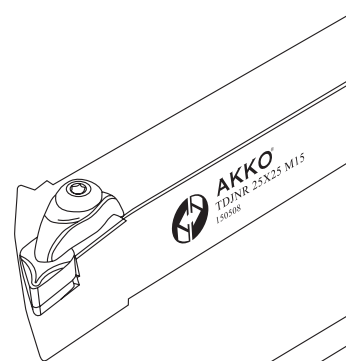

konusulan
the spoken kalite...
quality...





DIŞ TORNA TAKIMLARI
EXTERNAL TURNING TOOLHOLDERS
ДЕРЖАВКИ ДЛЯ НАРУЖНОГО ТОЧЕНИЯ





1 Sıkma Tipi / Method of Mounting of Insert / Способ монтажа вставки

P **S** **K** **N** **R**

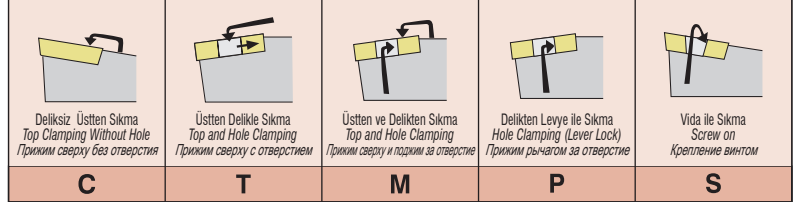

2 Uç Tipi / Type of Insert / Форма пластины

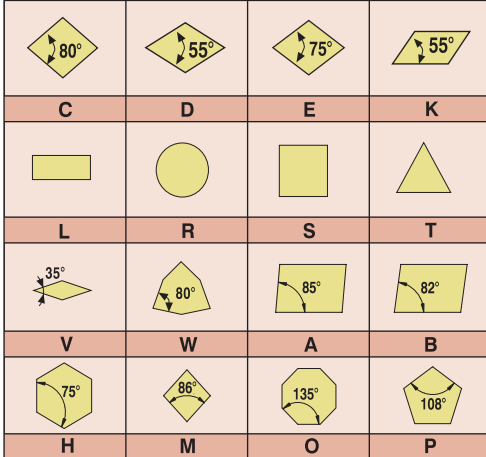

3 Yanaşma Açısı / Tool Holder Shape Bar Geometry / Угол направления

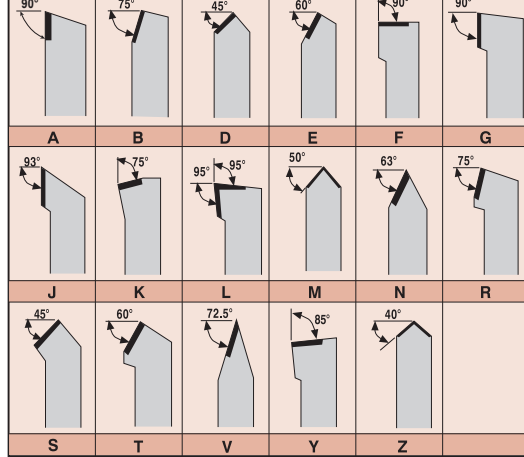

4 Serbest Uç Açısı / Insert Clearance Angle / Freiwinkel / Задний угол пластины

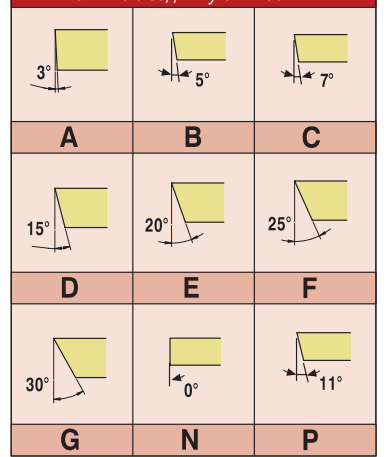

25 **25** - **M** **12** **C**

5 Kesme Yönü / Cutting Direction / Направление резания

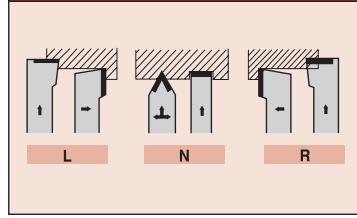

6 Kesme Kenar Yüksekliği / Cutting Edge Height / Высота режущей кромки

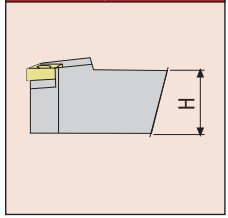

7 Şaft Genişliği / Shank Width / Ширина хвостовика

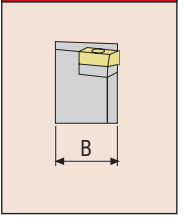

8 Şaft Boyu / Shank Length / Длина хвостовика

A - 32	H - 100	Q - 180	x-special
B - 40	J - 110	R - 200	
C - 50	K - 125	S - 250	
D - 60	L - 140	T - 300	
E - 70	M - 150	U - 350	
F - 80	N - 160	V - 400	
G - 90	P - 170	W - 450	

9 Kesme Kenar Uzunluğu / Cutting Edge Length / Длина режущей кромки

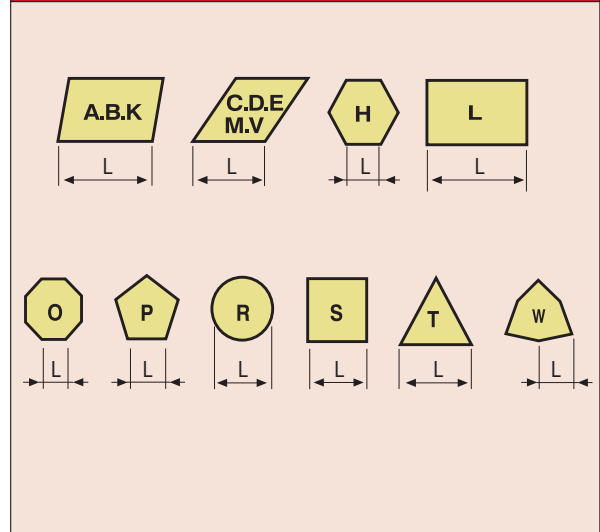

10 Baskı Pabucu / Wedge Clamp / Прижим

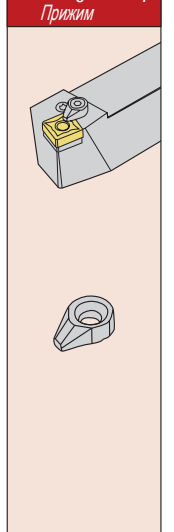



*konusulan
the spoken kalite...
quality...*

T-SİSTEM

T-SİSTEM DIŞ TORNA KATERLERİ
T-SYSTEM EXTERNAL TURNING TOOLHOLDERS
T-ТИП ДЕРЖАВКИ ДЛЯ НАРУЖНОГО ТОЧЕНИЯ



DETAYLI BİLGİ İÇİN BARKODU OKUTUNUZ
SCAN ME FOR MORE DETAILS

ПРОСКАНИРУЙТЕ ДЛЯ ПОЛУЧЕНИЯ БОЛЕЕ ПОДРОБНОЙ ИНФОРМАЦИИ

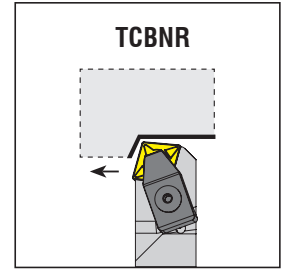
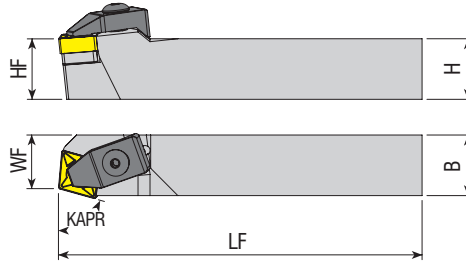
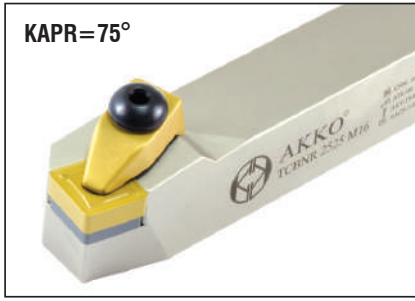

Takım Kodu Ordering Code Код для заказа	Stok Stock Наличие		Takım Ölçüleri (mm) Dimension (mm) Размеры (мм)				Kesici Uç Insert Пластина	Yedek Parçaları / Spare Parts / Запасные части								
	R	L	HF=H	B	LF	WF		Baskı Pabucu Wedge Clamp Прижим	Pabuç Vidası Clamp Screw Зажимной винт	Altlık Shim Опорная пластина	Altlık Vidası Shim Screw Винт опорной пластины	Segman Ring Кольцо	Pul Stamp Шайба	Anahtar Allen Key Ключ		
	●	●														
TCBNR/L 2525 M16	●	●	25	25	150	22	CNM. 1606..	ATK-04	AKV-19-M7x25	AACN-3-0002	AAV-05-M6x15	AS-02	ABPL-02	AAL-05-4		

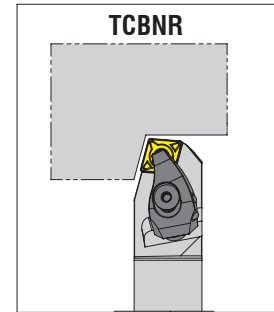
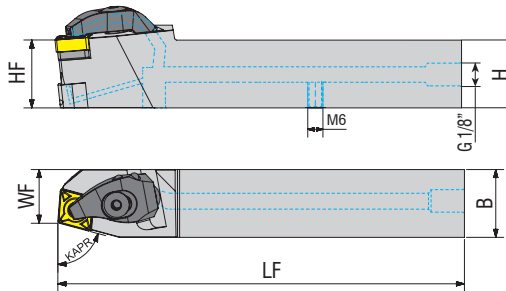

Takım Kodu Ordering Code Код для заказа	Stok Stock Наличие		Takım Ölçüleri (mm) Dimension (mm) Размеры (мм)				Kesici Uç Insert Пластина	Yedek Parçaları / Spare Parts / Запасные части									
	R	L	HF=H	B	LF	WF		Baskı Pabucu Wedge Clamp Прижим	Pabuç Vidası Clamp Screw Зажимной винт	Altlık Shim Опорная пластина	Altlık Vidası Shim Screw Винт опорной пластины	Yay Spring Пружина	Oring Ring Кольцо	Sızdırmaz Vida Threaded Pin Резьбовой Винт	Anahtar Allen Key Ключ		
	●	○															
TCBNR/L 2020 K12-H	○	○	20	20	125	16	CNM. 1204..	ATKH-01-R ATKH-02-L	AKV-33-M6x22	AACN-3-0001	AAV-02-M5x12	AKY-01	AXR-01	2705-G1/8x5.5	AAL-03-3		
2525 M12-H	○	○	25	25	150	20											
3232 P12-H	○	○	32	32	170	25											

R: Sağ / Right / Правый L: Sol / Left / Левый

● Stokta / In Stock / В наличии ○ Stokta Yok / Non Stock Item / Нет в наличии

VDI tutucu ile uyumludur. / Compatible with VDI holders. / degisecekmemogurdall demo

Sipariş Örneği/Ordering Example/Образец заказа

1 ad./pcs./шт. TCBNR 2525 M16

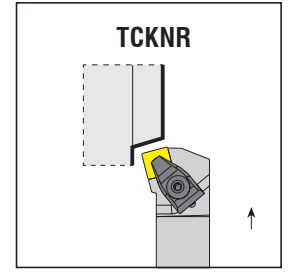
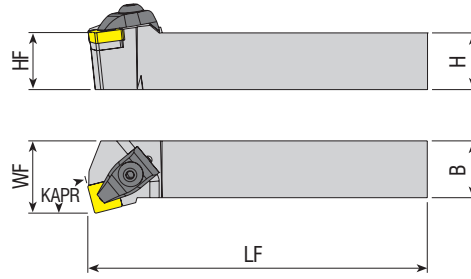

Takım Kodu Ordering Code Код для заказа	Stok Stock Наличие		Takım Ölçüleri (mm) Dimension (mm) Размеры (мм)				Kesici Uç Insert Пластина	Yedek Parçaları / Spare Parts / Запасные части									
	R	L	HF=H	B	LF	WF		Baskı Pabucu Wedge Clamp Прижим	Pabuç Vidası Clamp Screw Зажимной винт	Altık Shim Отпорная пластина	Altık Vidası Shim Screw Винт отпорной пластины	Segman Ring Кольцо	Pul Stamp Шайба	Anahtar Allen Key Ключ			
	●	○															
TCKNR/L 2020 K12	●	●	20	20	125	25	CNM. 1204..	ATK-02	AKV-30-M6x22	AACN-3-0001	AAV-02-M5x12	AS-01	ABPL-01	AAL-03-3			
2525 M12	●	●	25	25	150	32											
3232 P12	●	●	32	32	170	40											
TCKNR/L 2020 K12	●	●	25	25	150	32	CNM. 1606..	ATK-04	AKV-19-M7x25	AACN-3-0002	AAV-05-M6x15	AS-02	ABPL-02	AAL-05-4			
3232 P16	●	●	32	32	170	40											

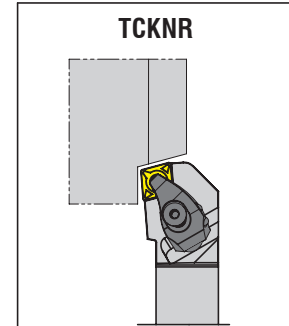
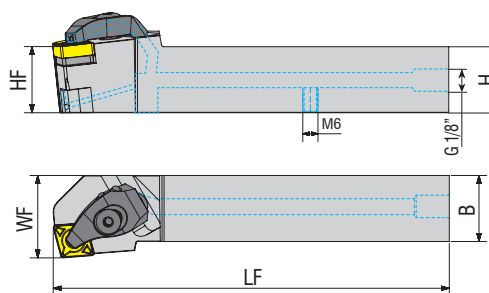

Takım Kodu Ordering Code Код для заказа	Stok Stock Наличие		Takım Ölçüleri (mm) Dimension (mm) Размеры (мм)				Kesici Uç Insert Пластина	Yedek Parçaları / Spare Parts / Запасные части									
	R	L	HF=H	B	LF	WF		Baskı Pabucu Wedge Clamp Прижим	Pabuç Vidası Clamp Screw Зажимной винт	Altık Shim Отпорная пластина	Altık Vidası Shim Screw Винт отпорной пластины	Yay Spring Пружина	Oring Ring Кольцо	Sızdırmaz Vida Threaded Pin Резьбовой Винт	Anahtar Allen Key Ключ		
	●	○															
TCKNR/L 2020 K12-H	○	○	20	20	125	25	CNM. 1204..	ATKH-01-R ATKH-02-L	AKV-33-M6x22	AACN-3-0001	AAV-13-M5x8	AKY-01	AXR-01	2705-G1/8x5.5	AAL-03-3		
2525 M12-H	○	○	25	25	150	32											
3232 P12-H	○	○	32	32	170	40											

R: Sağ / Right / Правый L: Sol / Left / Левый

● Stokta / In Stock / В наличии ○ Stokta Yok / Non Stock Item / Нет в наличии

VDI tutucu ile uyumludur. / Compatible with VDI holders. / degisecekmemogurdall demo

Sipariş Örneği/Ordering Example/Образец заказа

1 ad./pcs./шт. TCKNR 2020 K12

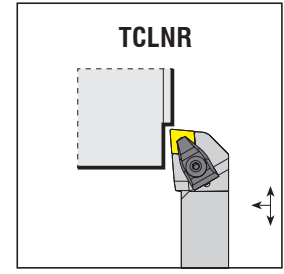
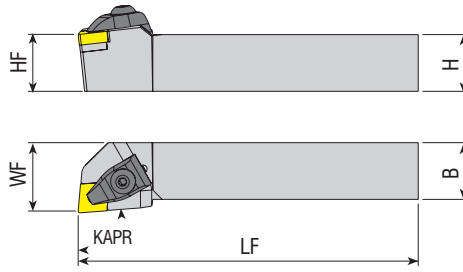

Takım Kodu
Ordering Code
Код для заказа

Takım Kodu Ordering Code Код для заказа	Stok Stock Наличие		Takım Ölçüleri (mm) Dimension (mm) Размеры (мм)				Kesici Uç Insert Пластина	Yedek Parçaları / Spare Parts / Запасные части							
	R	L	HF=H	B	LF	WF		Baskı Pabuçu Wedge Clamp Прижим	Pabuç Vidası Clamp Screw Зажимной винт	Altlık Shim Отпорная пластина	Altlık Vidası Shim Screw Винт отпорной пластины	Segman Ring Кольцо	Pul Stamp Шайба	Anahtar Allen Key Ключ	
TCLNR/L 2020 K12	●	●	20	20	125	25	CNM. 1204..								
2525 M12	●	●	25	25	150	32									
3232 P12	●	●	32	32	170	40									
4040 S12	●	●	40	40	250	50									
5050 S12	●	●	50	50	250	63									
2525 M16	●	●	25	25	150	32	CNM. 1606..								
3232 P16	●	●	32	32	170	40									

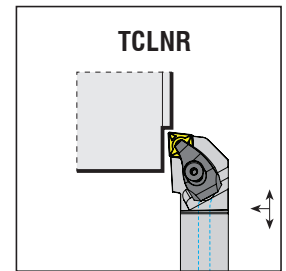
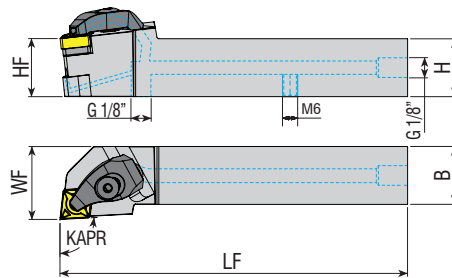
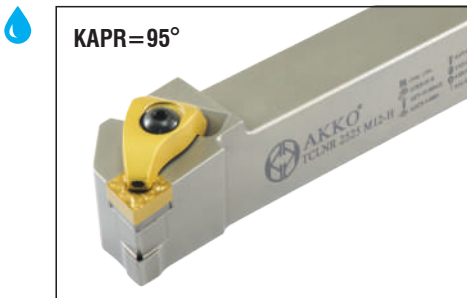

Takım Kodu
Ordering Code
Код для заказа

Takım Kodu Ordering Code Код для заказа	Stok Stock Наличие		Takım Ölçüleri (mm) Dimension (mm) Размеры (мм)				Kesici Uç Insert Пластина	Yedek Parçaları / Spare Parts / Запасные части							
	R	L	HF=H	B	LF	WF		Baskı Pabuçu Wedge Clamp Прижим	Pabuç Vidası Clamp Screw Зажимной винт	Altlık Shim Отпорная пластина	Altlık Vidası Shim Screw Винт отпорной пластины	Yay Spring Пружина	Oring Ring Кольцо	Sızdırmaz Vida Threaded Pin Резьбовой Винт	Anahtar Allen Key Ключ
TCLNR/L 2020 K12-H	●	●	20	20	125	25	CNM. 1204..								
2525 M12-H	●	●	25	25	150	32									
3232 P12-H	●	●	32	32	170	40									

R: Sağ / Right / Правый L: Sol / Left / Левый

● Stokta / In Stock / В наличии ○ Stokta Yok / Non Stock Item / Нет в наличии

VDI tutucu ile uyumludur. / Compatible with VDI holders. / degisecekmemogurdall demo

Sipariş Örneği/Ordering Example/Образец заказа

1 ad./pcs./шт. TCLNR 2020 K12

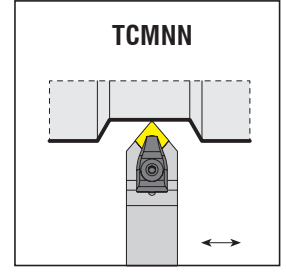
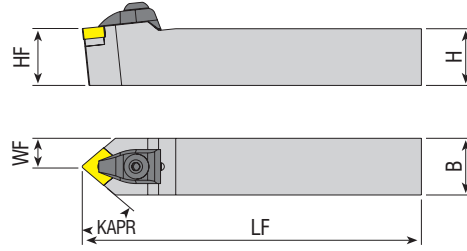

Takım Kodu Ordering Code Код для заказа	Stok Stock Наличие	Takım Ölçüleri (mm) Dimension (mm) Размеры (мм)				Kesici Uç Insert Пластина	Yedek Parçaları / Spare Parts / Запасные части							
		HF=H	B	LF	WF		Baskı Pabucu Wedge Clamp Прижим	Pabuç Vidası Clamp Screw Зажимной винт	Altlık Shim Опорная пластина	Altlık Vidası Shim Screw Винт опорной пластины	Segman Ring Кольцо	Pul Stamp Шайба	Anahtar Allen Key Ключ	
TCMNN 1616 H12	●	16	16	100	8	CNM. 1204..								
2020 K12	●	20	20	125	10									
2525 M12	●	25	25	150	12.5									
3232 P12	●	32	32	170	16									
2525 M16	●	25	25	150	12.5	CNM. 1606..								
3232 P16	●	32	32	170	16									
4040 S16	○	40	40	250	20									

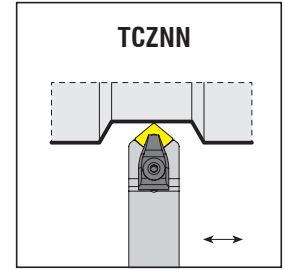
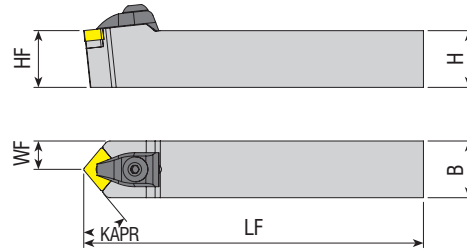

Takım Kodu Ordering Code Код для заказа	Stok Stock Наличие	Takım Ölçüleri (mm) Dimension (mm) Размеры (мм)				Kesici Uç Insert Пластина	Yedek Parçaları / Spare Parts / Запасные части							
		HF=H	B	LF	WF		Baskı Pabucu Wedge Clamp Прижим	Pabuç Vidası Clamp Screw Зажимной винт	Altlık Shim Опорная пластина	Altlık Vidası Shim Screw Винт опорной пластины	Segman Ring Кольцо	Pul Stamp Шайба	Anahtar Allen Key Ключ	
TCZNN 2020 K12	●	20	20	125	10	CNM. 1204..								
2525 M12	●	25	25	150	12.5									
3232 P12	●	32	32	170	16									
2525 M16	●	25	25	150	12.5	CNM. 1606..								
3232 P16	●	32	32	170	16									

R: Sağ / Right / Правый L: Sol / Left / Левый

● Stokta / In Stock / В наличии ○ Stokta Yok / Non Stock Item / Нет в наличии

Sipariş Örneği/Ordering Example/Образец заказа

1 ad./pcs./шт. TCMNN 1616 H12

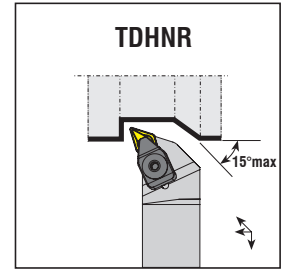
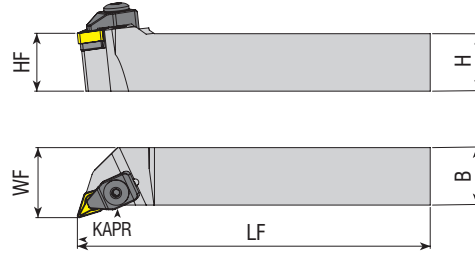

Takım Kodu Ordering Code Код для заказа	Stok Stock Наличие		Takım Ölçüleri (mm) Dimension (mm) Размеры (мм)				Kesici Uç Insert Пластина	Yedek Parçaları / Spare Parts / Запасные части						
	R	L	HF=H	B	LF	WF		Baskı Pabuçu Wedge Clamp Прижим	Pabuç Vidası Clamp Screw Закрепительный винт	Altlık Shim Отпорная пластина	Altlık Vidası Shim Screw Винт отпорной пластины	Segman Ring Кольцо	Pul Stamp Шайба	Anahtar Allen Key Ключ
	○	●												
TDHNR/L 2525 M11	○	●	25	25	150	31	DNM. 1104..	ATK-01	AKV-01-M5x22	AADN-2-0001	AAV-04-M5x12	-		
2020 K15	●	●	20	20	125	25								
2525 M15	●	●	25	25	150	32	DNM. 1506..	ATK-02	AKV-30-M6x22	AADN-3-0001	AAV-02-M5x12	AS-01	ABPL-01	AAL-03-3
3232 P15	●	●	32	32	170	40								

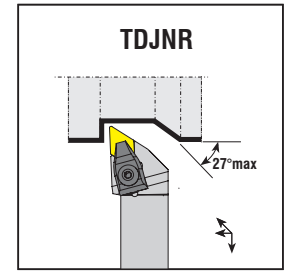
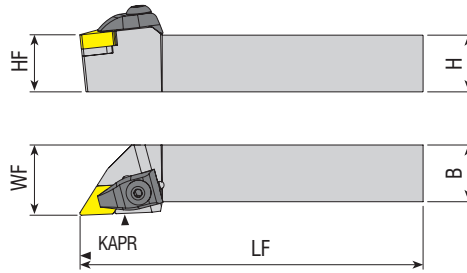
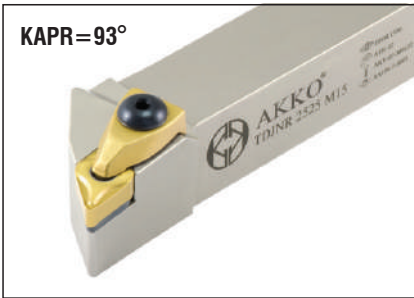

Takım Kodu Ordering Code Код для заказа	Stok Stock Наличие		Takım Ölçüleri (mm) Dimension (mm) Размеры (мм)				Kesici Uç Insert Пластина	Yedek Parçaları / Spare Parts / Запасные части						
	R	L	HF=H	B	LF	WF		Baskı Pabuçu Wedge Clamp Прижим	Pabuç Vidası Clamp Screw Закрепительный винт	Altlık Shim Отпорная пластина	Altlık Vidası Shim Screw Винт отпорной пластины	Segman Ring Кольцо	Pul Stamp Шайба	Anahtar Allen Key Ключ
	○	●												
TDJNR/L 1616 H11	●	●	16	16	100	20								
2020 K11	●	●	20	20	125	25	DNM. 1104..	ATK-01	AKV-01-M5x22	AADN-2-0001	AAV-04-M5x12	-		
2525 M11	●	●	25	25	150	32								
2020 K15	●	●	20	20	125	25								
2525 M15	●	●	25	25	150	32								
3232 P15	●	●	32	32	170	40	DNM. 1506..	ATK-02	AKV-30-M6x22	AADN-3-0001	AAV-02-M5x12	AS-01	ABPL-01	AAL-03-3
4040 S15	●	●	40	40	250	50								
5050 S15	○	○	50	50	250	63								
2020 K1504	●	●	20	20	125	25								
2525 M1504	●	●	25	25	150	32	DNM. 1504..	ATK-02	AKV-30-M6x22	AADN-2-0003	AAV-02-M5x12	AS-01		
3232 P1504	●	●	32	32	170	40								
4040 S1504	●	●	40	40	250	50								

R: Sağ / Right / Правый L: Sol / Left / Левый
● Stokta / In Stock / В наличии ○ Stokta Yok / Non Stock Item / Нет в наличии

Sipariş Örneği/Ordering Example/Образец заказа
1 ad./pcs./шт. TDHNR 2525 M11

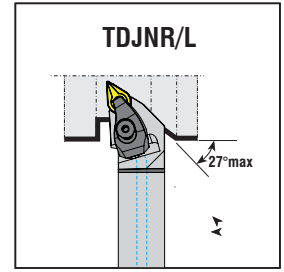
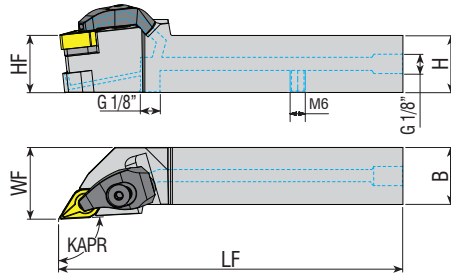

Takım Kodu Ordering Code Код для заказа	Stok Stock Наличие		Takım Ölçüleri (mm) Dimension (mm) Размеры (мм)				Kesici Uç Insert Пластина	Yedek Parçaları / Spare Parts / Запасные части															
	R	L	HF=H	B	LF	WF		Baskı Pabuçu Wedge Clamp Прижим	Pabuç Vidası Clamp Screw Зажимной винт	Altlık Shim Опорная пластина	Altlık Vidası Shim Screw Винт опорной пластины	Yay Spring Пружина	O-ring Ring Кольцо	Sızdırmaz Vida Threaded Pin Резьбовой Винт	Anahtar Allen Key Ключ								
TDJNR/L 2020 K15-H	●	●	20	20	125	25	DNM. 1506..																
2525 M15-H	●	●	25	25	150	32										ATKH-01-R	AKV-33-M6x22	AADN-3-0001	AAV-13-M5x8	AKY-01	AXR-01	2705-G1/8x5.5	AAL-03-3
3232 P15-H	●	●	32	32	170	40										ATKH-02-L							

VDI tutucu ile uyumludur. / Compatible with VDI holders. / degisecekmemogurdall demo

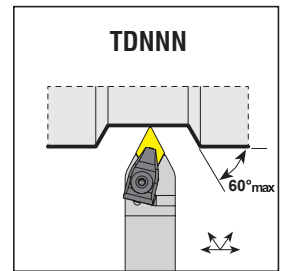
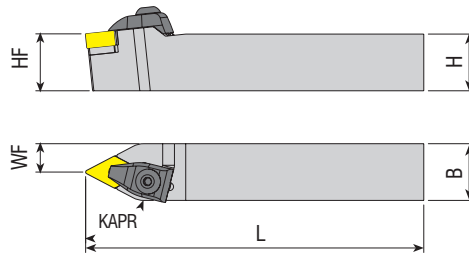

Takım Kodu Ordering Code Код для заказа	Stok Stock Наличие	Takım Ölçüleri (mm) Dimension (mm) Размеры (мм)				Kesici Uç Insert Пластина	Yedek Parçaları / Spare Parts / Запасные части													
		HF=H	B	LF	WF		Baskı Pabuçu Wedge Clamp Прижим	Pabuç Vidası Clamp Screw Зажимной винт	Altlık Shim Опорная пластина	Altlık Vidası Shim Screw Винт опорной пластины	Segman Ring Кольцо	Pul Stamp Шайба	Anahtar Allen Key Ключ							
TDNNN 1616 H11	●	16	16	100	8	DNM. 1104..														
2020 K11	●	20	20	125	10									ATK-01	AKV-01-M5x22	AADN-2-0001	AAV-04-M5x12	-		
2525 M11	●	25	25	150	12.5															
2020 K15	●	20	20	125	10	DNM. 1506..														
2525 M15	●	25	25	150	12.5									ATK-02	AKV-30-M6x22	AADN-3-0001	AAV-02-M5x12	AS-01	ABPL-01	AAL-03-3
3232 P15	●	32	32	170	16															
4040 S15	○	40	40	250	20															
5050 S15	○	50	50	250	25															

R: Sağ / Right / Правый L: Sol / Left / Левый

● Stokta / In Stock / В наличии ○ Stokta Yok / Non Stock Item / Нет в наличии

Sipariş Örneği/Ordering Example/Образец заказа

1 ad./pcs./шт. TDJNR 2020 K15-H

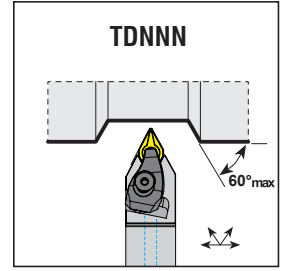
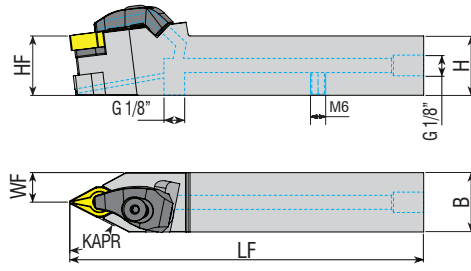

Takım Kodu Ordering Code Код для заказа	Stok Stock Наличие	Takım Ölçüleri (mm) Dimension (mm) Размеры (мм)				Kesici Uç Insert Пластина	Yedek Parçaları / Spare Parts / Запасные части									
		HF=H	B	LF	WF		Baskı Pabucu Wedge Clamp Прижим	Pabuç Vidası Clamp Screw Зажимной винт	Altlık Shim Опорная пластина	Altlık Vidası Shim Screw Винт опорной пластины	Yay Spring Пружина	Oring Ring Кольцо	Sızdırmaz Vida Threaded Pin Разъёмной Винт	Anahtar Allen Key Ключ		
TDNNN 2525 M15-H	●	25	25	150	32	DNM. 1506..	ATKH-01-R ATKH-02-L	AKV-33-M6x22	AADN-3-0001	AAV-13-M5x8	AKY-01	AXR-01	2705-G1/8x5.5	AAL-03-3		

VDI tutucu ile uyumludur. / Compatible with VDI holders. / degiseceekmemogurdall demo

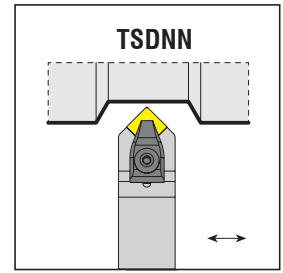
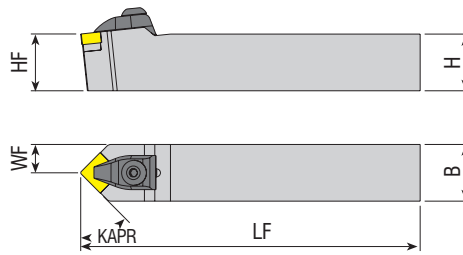

Takım Kodu Ordering Code Код для заказа	Stok Stock Наличие	Takım Ölçüleri (mm) Dimension (mm) Размеры (мм)				Kesici Uç Insert Пластина	Yedek Parçaları / Spare Parts / Запасные части									
		HF=H	B	LF	WF		Baskı Pabucu Wedge Clamp Прижим	Pabuç Vidası Clamp Screw Зажимной винт	Altlık Shim Опорная пластина	Altlık Vidası Shim Screw Винт опорной пластины	Segman Ring Кольцо	Pul Stamp Шайба	Anahtar Allen Key Ключ			
TSDNN 1616 H12	●	16	16	100	8	SNM. 1204..	ATK-02	AKV-30-M6x22	AASN-3-0004	AAV-02-M5x12	AS-01	ABPL-01	AAL-03-3			
2020 K12	●	20	20	125	10											
2525 M12	●	25	25	150	12.5											
3232 P12	●	32	32	170	16	SNM. 1506..	ATK-04	AKV-19-M7x25	AASN-3-0023	AAV-05-M6x15	AS-02	ABPL-02	AAL-05-4			
2525 M15	○	25	25	150	12.5											
3232 P15	●	32	32	170	16											
4040 S15	○	40	40	250	20											

R: Sağ / Right / Правый L: Sol / Left / Левый

● Stokta / In Stock / В наличии ○ Stokta Yok / Non Stock Item / Нет в наличии

Sipariş Örneği/Ordering Example/Образец заказа

1 ad./pcs./шт. TDNNN 2525 M15-H

T-SİSTEM DIŞ TORNA KATERLERİ
T-SYSTEM EXTERNAL TURNING TOOLHOLDERS
T-ТИП ДЕРЖАВКИ ДЛЯ НАРУЖНОГО ТОЧЕНИЯ

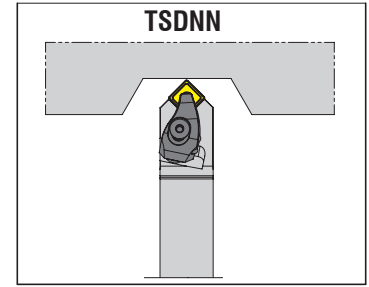
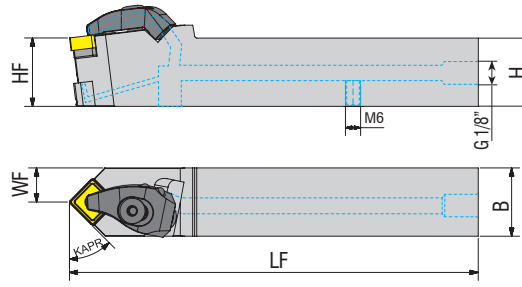

Takım Kodu Ordering Code Код для заказа	Stok Stock Наличие		Takım Ölçüleri (mm) Dimension (mm) Размеры (мм)				Kesici Uç Insert Пластина	Yedek Parçaları / Spare Parts / Запасные части									
	R	L	HF=H	B	LF	WF		Baskı Pabuçu Wedge Clamp Прижим	Pabuç Vidası Clamp Screw Зажимной винт	Altlık Shim Опорная пластина	Altlık Vidası Shim Screw Винт опорной пластины	Yay Spring Пружина	Oring Ring Кольцо	Sızdırmaz Vida Threaded Pin Резьбовой Винт	Anahtar Allen Key Ключ		
TSDNN 2525 M12-H	●	○	25	25	150	25	SNM. 1204..	ATKH-01-R ATKH-02-L	AKV-33-M6x22	AASN-3-0004	AAV-02-M5x12			2705-G1/8x5.5	AAL-03-3		
3232 P12-H	●	○	32	32	170	16											
2525 M15-H	●	○	25	25	150	12.7	SNM. 1506..	ATKH-07-R ATKH-08-L	AKV-39-M7x21	AASN-3-0023	AAV-05-M6x10	AKY-01	AXR-01	2705-G1/8x5.5	AAL-05-4		
3232 P15-H	●	○	32	32	170	16											
4040 S15-H	●	○	40	40	250	20											

VDI tutucu ile uyumludur. / Compatible with VDI holders. / degiseceekmemogurdall demo

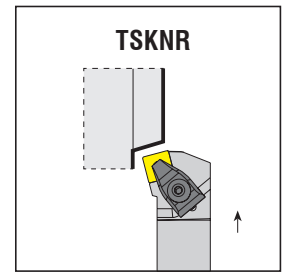
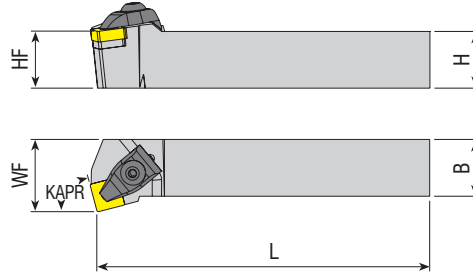

Takım Kodu Ordering Code Код для заказа	Stok Stock Наличие		Takım Ölçüleri (mm) Dimension (mm) Размеры (мм)				Kesici Uç Insert Пластина	Yedek Parçaları / Spare Parts / Запасные части							
	R	L	HF=H	B	LF	WF		Baskı Pabuçu Wedge Clamp Прижим	Pabuç Vidası Clamp Screw Зажимной винт	Altlık Shim Опорная пластина	Altlık Vidası Shim Screw Винт опорной пластины	Segman Ring Кольцо	Pul Stamp Шайба	Anahtar Allen Key Ключ	
TSKNR/L 2020 K12	●	●	20	20	125	25	SNM. 1204..	ATK-02	AKV-30-M6x22	AASN-3-0004	AAV-02-M5x12	AS-01	ABPL-01	AAL-03-3	
2525 M12	●	●	25	25	150	32									
3232 P12	●	●	32	32	170	40									
3232 P15	●	●	32	32	170	40	SNM. 1506..	ATK-04	AKV-19-M7x25	AASN-3-0023	AAV-05-M6x15	AS-02	ABPL-02	AAL-05-4	

R: Sağ / Right / Правый L: Sol / Left / Левый

● Stokta / In Stock / В наличии ○ Stokta Yok / Non Stock Item / Нет в наличии

Sipariş Örneği/Ordering Example/Образец заказа

1 ad./pcs./шт. TSDNN 2525 M12-H



www.akkо.com.tr

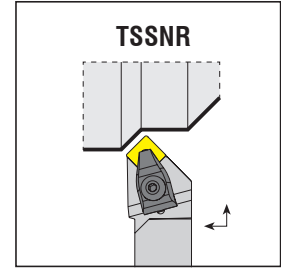
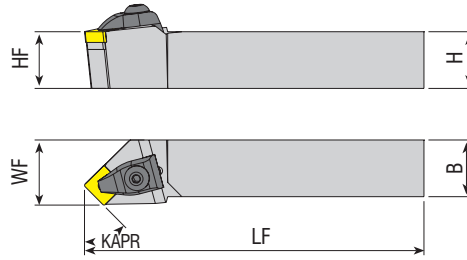

Takım Kodu Ordering Code Код для заказа	Stok Stock Наличие		Takım Ölçüleri (mm) Dimension (mm) Размеры (мм)				Kesici Uç Insert Пластина	Yedek Parçaları / Spare Parts / Запасные части													
	R	L	HF=H	B	LF	WF		Baskı Pabuçu Wedge Clamp Прижим	Pabuç Vidası Clamp Screw Зажимной винт	Altlık Shim Опорная пластина	Altlık Vidası Shim Screw Винт опорной пластины	Segman Ring Кольцо	Pul Stamp Шайба	Anahtar Allen Key Ключ							
TSSNR/L 2020 K12	●	●	20	20	125	25	SNM. 1204..														
2525 M12	●	●	25	25	150	32									ATK-02	AKV-30-M6x22	AASN-3-0004	AAV-02-M5x12	AS-01	ABPL-01	AAL-03-3
3232 P12	●	●	32	32	170	40															
2525 M15	●	●	25	25	150	32	SNM. 1506..														
3232 P15	●	●	32	32	170	40									ATK-04	AKV-19-M7x25	AASN-3-0023	AAV-05-M6x15	AS-02	ABPL-02	AAL-05-4

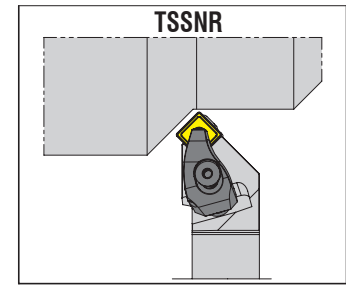
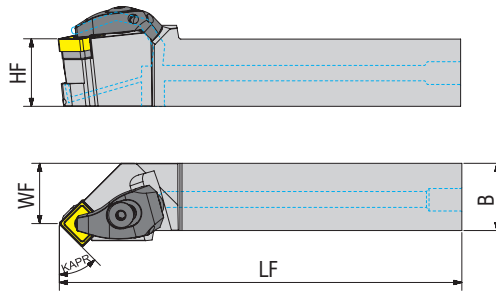

Takım Kodu Ordering Code Код для заказа	Stok Stock Наличие		Takım Ölçüleri (mm) Dimension (mm) Размеры (мм)				Kesici Uç Insert Пластина	Yedek Parçaları / Spare Parts / Запасные части															
	R	L	HF=H	B	LF	WF		Baskı Pabuçu Wedge Clamp Прижим	Pabuç Vidası Clamp Screw Зажимной винт	Altlık Shim Опорная пластина	Altlık Vidası Shim Screw Винт опорной пластины	Yay Spring Пружина	Oring Ring Кольцо	Sızdırmaz Vida Threaded Pin Резьбовой Винт	Anahtar Allen Key Ключ								
TSSNR/L 2525 M12-H	○	○	25	25	150	32	SNM. 1204..																
3232 P12-H	○	○	32	32	170	32										ATKH-01-R	AKV-33-M6x22	AASN-3-0004	AAV-02-M5x12				AAL-03-3
2525 M15-H	○	○	25	25	150	40	SNM. 1506..																
3232 P15-H	○	○	32	32	170	40										ATKH-07-R	AKV-39-M7x21	AASN-3-0023	AAV-05-M6x10	AKY-01	AXR-01	2705-G1/8x5.5	AAL-05-4
4040 S15-H	○	○	40	40	250	50										ATKH-08-L							

R: Sağ / Right / Правый L: Sol / Left / Левый
● Stokta / In Stock / В наличии ○ Stokta Yok / Non Stock Item / Нет в наличии
VDI tutucu ile uyumludur. / Compatible with VDI holders. / degisecekmemogurdall demo

Sipariş Örneği/Ordering Example/Образец заказа
1 ad./pcs./шт. TSSNR 2020 K12

➤ **T-SİSTEM DIŞ TORNA KATERLERİ**
T-SYSTEM EXTERNAL TURNING TOOLHOLDERS
T-ТИП ДЕРЖАВКИ ДЛЯ НАРУЖНОГО ТОЧЕНИЯ

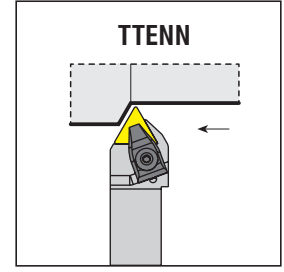
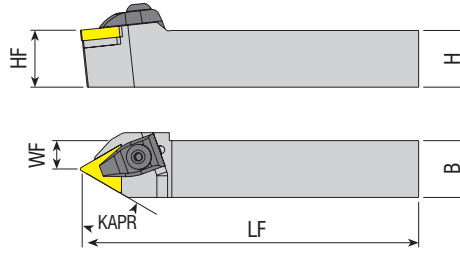

Takım Kodu Ordering Code Код для заказа	Stok Stock Наличие		Takım Ölçüleri (mm) Dimension (mm) Размеры (мм)				Kesici Uç Insert Пластина	Yedek Parçaları / Spare Parts / Запасные части						
	R	L	HF=H	B	LF	WF		Baskı Pabuçu Wedge Clamp Прижим	Pabuç Vidası Clamp Screw Зажимной винт	Altık Shim Отпорная пластина	Altık Vidası Shim Screw Винт отпорной пластины	Segman Ring Кольцо	Pul Stamp Шайба	Anahtar Allen Key Ключ
TTENN 2020 K16	●		20	20	125	10	TNM. 1604..					-	ABPL-01	AAL-03-3
2525 M16	●		25	25	150	12.5								
3232 P16	●		32	32	170	16								
2525 M22	●		25	25	150	12.5	TNM. 2204..					AS-01	ABPL-01	AAL-03-3
3232 P22	●		32	32	170	16								
4040 S22	○		40	40	250	20								

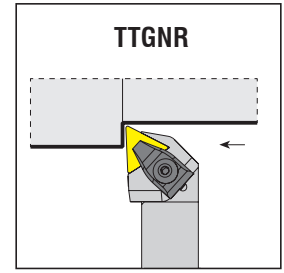
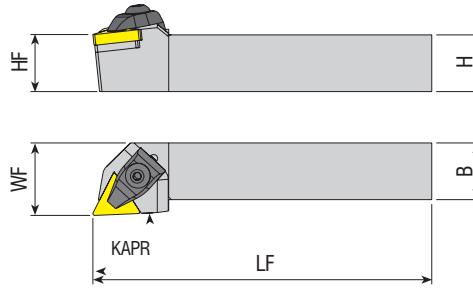

Takım Kodu Ordering Code Код для заказа	Stok Stock Наличие		Takım Ölçüleri (mm) Dimension (mm) Размеры (мм)				Kesici Uç Insert Пластина	Yedek Parçaları / Spare Parts / Запасные части						
	R	L	HF=H	B	LF	WF		Baskı Pabuçu Wedge Clamp Прижим	Pabuç Vidası Clamp Screw Зажимной винт	Altık Shim Отпорная пластина	Altık Vidası Shim Screw Винт отпорной пластины	Segman Ring Кольцо	Pul Stamp Шайба	Anahtar Allen Key Ключ
TTGNR/L 2020 K16	●	●	20	20	125	25	TNM. 1604..					-	ABPL-01	AAL-03-3
2525 M16	●	●	25	25	150	32								
3232 P16	●	●	32	32	170	40								
2525 M22	●	●	25	25	150	32	TNM. 2204..					AS-01	ABPL-01	AAL-03-3
3232 P22	●	●	32	32	170	40								
4040 S22	●	○	40	40	250	50								

R: Sağ / Right / Правый L: Sol / Left / Левый
 ● Stokta / In Stock / В наличии ○ Stokta Yok / Non Stock Item / Нет в наличии

Sipariş Örneği/Ordering Example/Образец заказа
 1 ad./pcs./шт. TTENN 2020 K16

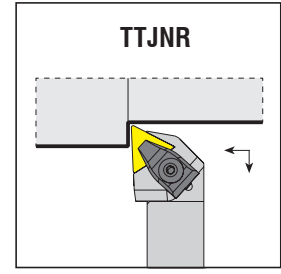
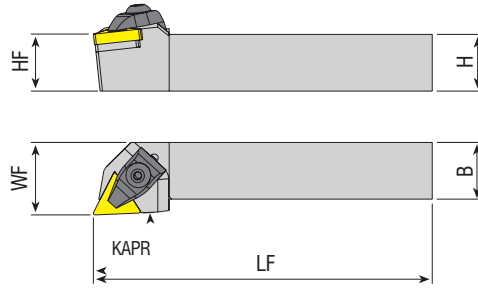

Takım Kodu Ordering Code Код для заказа	Stok Stock Наличие		Takım Ölçüleri (mm) Dimension (mm) Размеры (мм)				Kesici Uç Insert Пластина	Yedek Parçaları / Spare Parts / Запасные части							
	R	L	HF=H	B	LF	WF		Baskı Pabucu Wedge Clamp Прижим	Pabuç Vidası Clamp Screw Зажимный винт	Altlık Shim Опорная пластина	Altlık Vidası Shim Screw Винт опорной пластины	Segman Ring Кольцо	Pul Stamp Шайба	Anahtar Allen Key Ключ	
TTJNR/L 2020 K16	●	●	20	20	125	25	TNM. 1604..		AKV-01-M5x22	AATN-2-0002	AAV-03-M5x12	-	ABPL-01	AAL-03-3	
2525 M16	●	●	25	25	150	32									
3232 P16	●	●	32	32	170	40									
2525 M22	●	●	25	25	150	32	TNM. 2204..	ATK-02	AKV-30-M6x22	AATN-3-0015	AAV-02-M5x12	AS-01	ABPL-01	AAL-03-3	
3232 P22	●	●	32	32	170	40									
4040 S22	○	○	40	40	250	50									

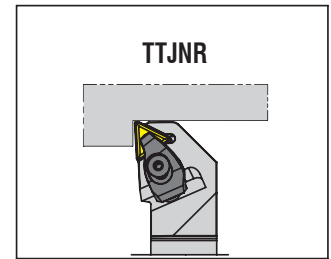
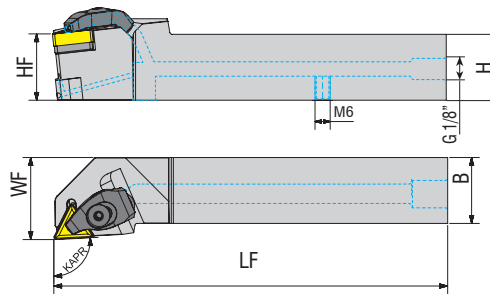

Takım Kodu Ordering Code Код для заказа	Stok Stock Наличие		Takım Ölçüleri (mm) Dimension (mm) Размеры (мм)				Kesici Uç Insert Пластина	Yedek Parçaları / Spare Parts / Запасные части							
	R	L	HF=H	B	LF	WF		Baskı Pabucu Wedge Clamp Прижим	Pabuç Vidası Clamp Screw Зажимный винт	Altlık Shim Опорная пластина	Altlık Vidası Shim Screw Винт опорной пластины	Yay Spring Пружина	Oring Ring Кольцо	Sızdırmaz Vida Threaded Pin Резьбовой Винт	Anahtar Allen Key Ключ
TTJNR/L 2525 M16-H	○	○	25	25	150	32	TNM. 1604..	ATKH-03-R	AKV-37-M5x18	AATN-2-0002	AAV-03-M5x12	AKY-02	AXR-02	2705-G1/8x5.5	AAL-02-2.5
3232 P16-H	○	○	32	32	170	32									
2525 M22-H	○	○	25	25	150	40	TNM. 2204..	ATKH-01-R	AKV-33-M6x22	AATN-3-0015	AAV-02-M5x12	AKY-01	AXR-01	AAL-03-3	
3232 P22-H	○	○	32	32	170	40									

R: Sağ / Right / Правый L: Sol / Left / Левый

● Stokta / In Stock / В наличии ○ Stokta Yok / Non Stock Item / Нет в наличии

VDI tutucu ile uyumludur. / Compatible with VDI holders. / degisecekmemogurdall demo

Sipariş Örneği/Ordering Example/Образец заказа

1 ad./pcs./шт. TTJNR 2020 K16

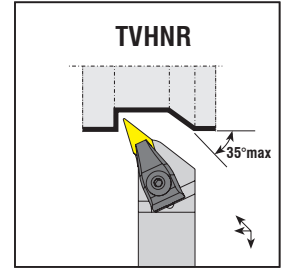
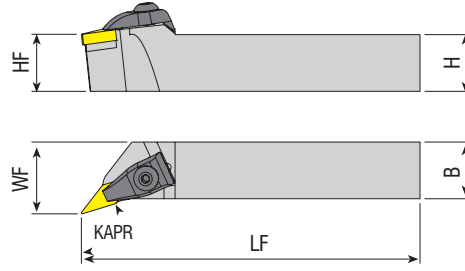

Takım Kodu Ordering Code Код для заказа	Stok Stock Наличие		Takım Ölçüleri (mm) Dimension (mm) Размеры (мм)				Kesici Uç Insert Пластина	Yedek Parçaları / Spare Parts / Запасные части								
	R	L	HF=H	B	LF	WF		Baskı Pabuçu Wedge Clamp Прижим	Pabuç Vidası Clamp Screw Закрепительный винт	Altlık Shim Опорная пластина	Altlık Vidası Shim Screw Винт опорной пластины	Segman Ring Кольцо	Pul Stamp Шайба	Anahtar Allen Key Ключ		
TVHNR/L 2020 K16	●	●	20	20	125	25	VNM. 1604..									
2525 M16	●	●	25	25	150	32										
3232 P16	●	●	32	32	170	40										

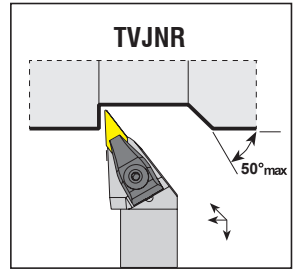
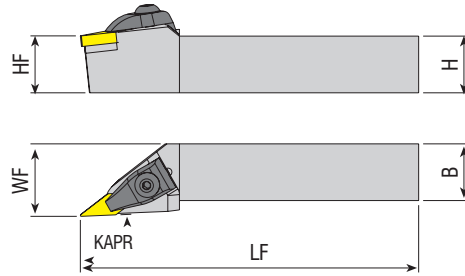

Takım Kodu Ordering Code Код для заказа	Stok Stock Наличие		Takım Ölçüleri (mm) Dimension (mm) Размеры (мм)				Kesici Uç Insert Пластина	Yedek Parçaları / Spare Parts / Запасные части								
	R	L	HF=H	B	LF	WF		Baskı Pabuçu Wedge Clamp Прижим	Pabuç Vidası Clamp Screw Закрепительный винт	Altlık Shim Опорная пластина	Altlık Vidası Shim Screw Винт опорной пластины	Segman Ring Кольцо	Pul Stamp Шайба	Anahtar Allen Key Ключ		
TVJNR/L 2020 K16	●	●	20	20	125	25	VNM. 1604..									
2525 M16	●	●	25	25	150	32										
3232 P16	●	●	32	32	170	40										

R: Sağ / Right / Правый L: Sol / Left / Левый
● Stokta / In Stock / В наличии ○ Stokta Yok / Non Stock Item / Нет в наличии

Sipariş Örneği/Ordering Example/Образец заказа
1 ad./pcs./шт. TVHNR 2020 K16

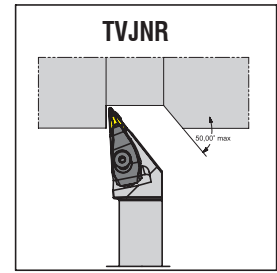
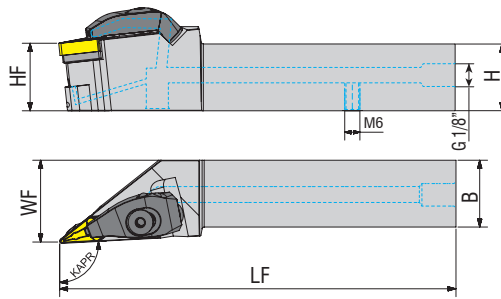

Takım Kodu Ordering Code Код для заказа	Stok Stock Наличие		Takım Ölçüleri (mm) Dimension (mm) Размеры (мм)				Kesici Uç Insert Пластина	Yedek Parçaları / Spare Parts / Запасные части															
	R	L	HF=H	B	LF	WF		Baskı Pabuçu Wedge Clamp Прижим	Pabuç Vidası Clamp Screw Зажимной винт	Altlık Shim Опорная пластина	Altlık Vidası Shim Screw Винт опорной пластины	Yay Spring Пружина	Oring Ring Кольцо	Sızdırmaz Vida Threaded Pin Резьбовой Винт	Anahtar Allen Key Ключ								
TVJNR/L 2020 K16-H	○	○	20	20	125	25	VNM. 1604..																
2525 M16-H	○	○	25	25	150	32										ATKH-05-R	AKV-33-M6x22	AAVN-2-0002	AAV-04-M5x12	AKY-01	AXR-01	2705-G1/8x5.5	AAL-03-3
3232 P16-H	○	○	32	32	170	40										ATKH-06-L							

VDI tutucu ile uyumludur. / Compatible with VDI holders. / degisecekmemogurdall demo

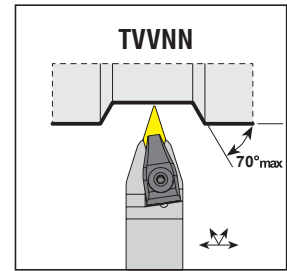
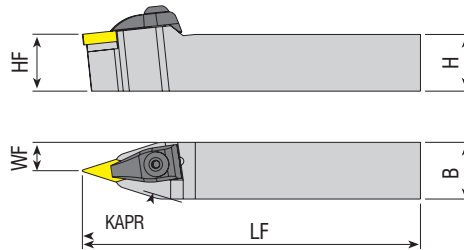

Takım Kodu Ordering Code Код для заказа	Stok Stock Наличие		Takım Ölçüleri (mm) Dimension (mm) Размеры (мм)				Kesici Uç Insert Пластина	Yedek Parçaları / Spare Parts / Запасные части													
			HF=H	B	LF	WF		Baskı Pabuçu Wedge Clamp Прижим	Pabuç Vidası Clamp Screw Зажимной винт	Altlık Shim Опорная пластина	Altlık Vidası Shim Screw Винт опорной пластины	Segman Ring Кольцо	Pul Stamp Шайба	Anahtar Allen Key Ключ							
TVVNN 2020 K16	●		20	20	125	10	VNM. 1604..														
2525 M16	●		25	25	150	12.5									ATK-03	AKV-30-M6x22	AAVN-2-0002	AAV-04-M5x12	AS-01	ABPL-01	AAL-03-3
3232 P16	●		32	32	170	16															

R: Sağ / Right / Правый L: Sol / Left / Левый
● Stokta / In Stock / В наличии ○ Stokta Yok / Non Stock Item / Нет в наличии

Sipariş Örneği/Ordering Example/Образец заказа
1 ad./pcs./шт. TVJNR 2020 K16-H

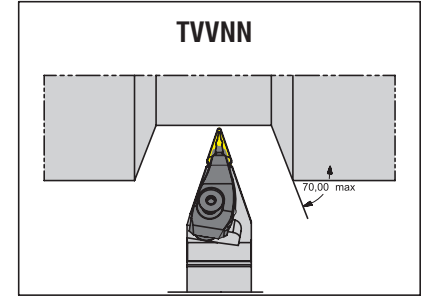
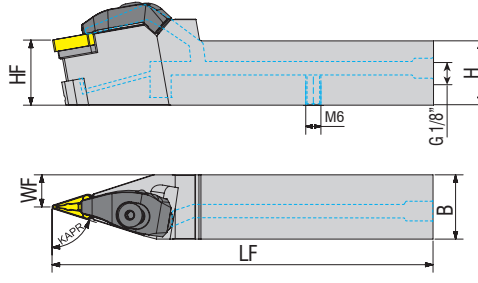
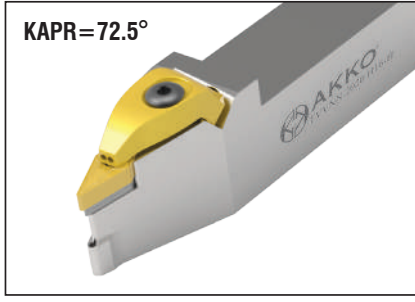

Takım Kodu Ordering Code Код для заказа	Stok Stock Наличие		Takım Ölçüleri (mm) Dimension (mm) Размеры (мм)				Kesici Uç Insert Пластина	Yedek Parçaları / Spare Parts / Залпасные части							
	R	L	HF=H	B	LF	WF		Baskı Pabuçu Wedge Clamp Прижим	Pabuç Vidası Clamp Screw Зажимной винт	Altlık Shim Опорная пластина	Altlık Vidası Shim Screw Винт опорной пластины	Yay Spring Пружина	Oring Ring Кольцо	Sızdırmaz Vida Threaded Pin Резьбовой Винт	Anahtar Allen Key Ключ
TVVNN 2020 K16-H	●	○	20	20	125	10	VNM. 1604..	ATKH-05-R ATKH-06-L	AKV-33-M6x22	AAVN-2-0002	AAV-04-M5x12	AKY-01	AXR-01	2705-G1/8x5.5	AAL-03-3
2525 M16-H	●	○	25	25	150	12.7									

VDI tutucu ile uyumludur. / Compatible with VDI holders. / degisecekmemogurdall demo

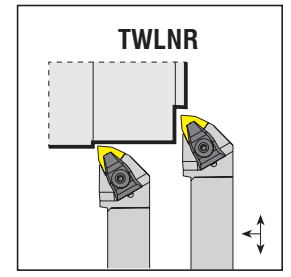
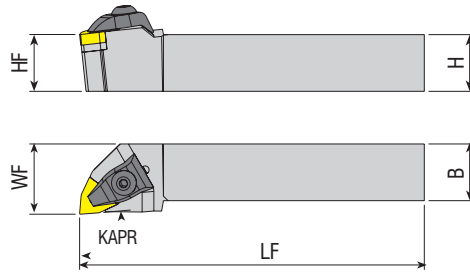

Takım Kodu Ordering Code Код для заказа	Stok Stock Наличие		Takım Ölçüleri (mm) Dimension (mm) Размеры (мм)				Kesici Uç Insert Пластина	Yedek Parçaları / Spare Parts / Залпасные части							
	R	L	HF=H	B	LF	WF		Baskı Pabuçu Wedge Clamp Прижим	Pabuç Vidası Clamp Screw Зажимной винт	Altlık Shim Опорная пластина	Altlık Vidası Shim Screw Винт опорной пластины	Segman Ring Кольцо	Pul Stamp Шайба	Anahtar Allen Key Ключ	
TWLNR/L 1616 H06	●	●	16	16	100	20	WNM. 0604..	ATK-01	AKV-01-M5x22	AAWN-SW317	AAV-01-M3x10				
2020 K06	●	●	20	20	125	25									
2525 M06	●	●	25	25	150	32									
2020 K08	●	●	20	20	125	25	WNM. 0804..	ATK-02	AKV-30-M6x22	AAWN-3-0001	AAV-02-M5x12	AS-01	ABPL-01	AAL-03-3	
2525 M08	●	●	25	25	150	32									
3232 P08	●	●	32	32	170	40									
4040 S08	●	●	40	40	250	50									
5050 S08	○	○	50	50	250	63									

R: Sağ / Right / Правый L: Sol / Left / Левый
● Stokta / In Stock / В наличии ○ Stokta Yok / Non Stock Item / Нет в наличии

Sipariş Örneği/Ordering Example/Образец заказа
1 ad./pcs./шт. TVVNN 2020 K16-H

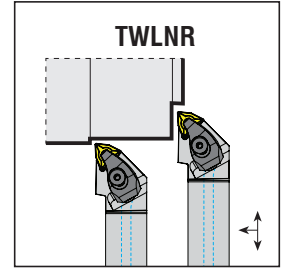
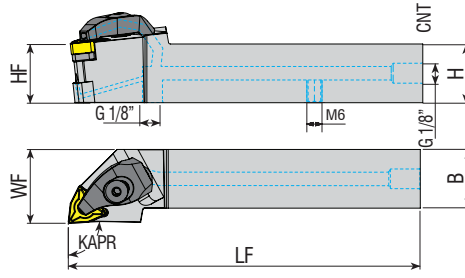

Takım Kodu
Ordering Code
Код для заказа

Takım Kodu Ordering Code Код для заказа	Stok Stock Наличие		Takım Ölçüleri (mm) Dimension (mm) Размеры (мм)				Kesici Uç Insert Пластина	Yedek Parçaları / Spare Parts / Запасные части									
	R	L	HF=H	B	LF	WF		Baskı Pabuçu Wedge Clamp Прижим	Pabuç Vidası Clamp Screw Закрепительный винт	Altlık Shim Отверная пластина	Altlık Vidası Shim Screw Винт отверной пластины	Yay Spring Пружина	Oring Ring Кольцо	Sızdırmaz Vida Threaded Pin Резьбовой Винт	Anahtar Allen Key Ключ		
TWLNR/L 2020 K08-H	●	●	20	20	125	25	WNM. 0804..										
2525 M08-H	●	●	25	25	150	32											
3232 P08-H	●	●	32	32	170	40											

R: Sağ / Right / Правый L: Sol / Left / Левый

● Stokta / In Stock / В наличии ○ Stokta Yok / Non Stock Item / Нет в наличии

VDI tutucu ile uyumludur. / Compatible with VDI holders. / degiseceekmemogurdall demo

Sipariş Örneği/Ordering Example/Образец заказа

1 ad./pcs./шт. TWLNR 2020 K08-H



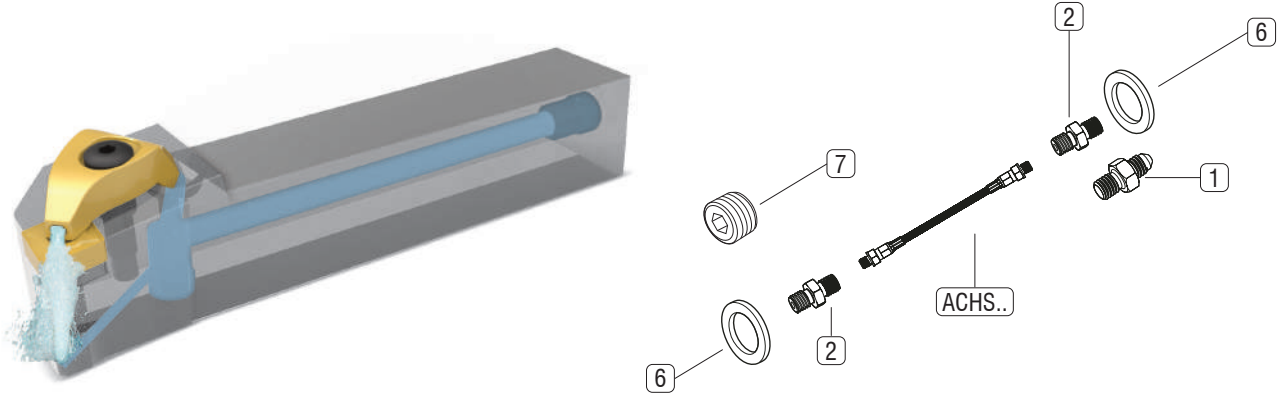

Not: İçten soğutmalı tüm torna katerlerinde kullanılabilecek 3 tip soğutma hortum setleri tasarlanmıştır. Takımların kullanılmasından önce, kullanılmayan bağlantıların set içindeki vida ile kapatılarak sızdırmazlığın sağlanmasına dikkat edilmelidir. Torna katerlerine yönelik soğutma hortum setleri, ACHS... 10 bar ile maksimum 150 bar basınç aralığında kullanılabilir.

Note: 3 types of cooling hose sets are designed that can be used in all internally cooled lathes. Before using the tools, care should be taken to ensure that the unused connections are closed with the screw in the set and that sealing is ensured. Cooling hose sets for lathe tools can be used in the pressure range of ACHS ... 10 bar to max 150 bar.

Примечание: Предлагается 3 типа комплектов трубок для подвода СОЖ. Они могут использоваться на всех токарных станках оснащенных системой подвода СОЖ. Перед началом работ необходимо закрыть неиспользуемые соединения винтом из набора и обеспечить герметичность системы подвода СОЖ. Комплекты охлаждающих трубок, для токарных инструментов, могут использоваться в диапазоне давлений АСНС от 10 бар до 150 бар.

Set İçindeki Parçalar Parts In The Set Запчасти в Наборе				Uzunluk / Length Code / Длина		
				Set Kodu: Set Code: Код Набора: ACHS-1-250	Set Kodu: Set Code: Код Набора: ACHS-2-250	Set Kodu: Set Code: Код Набора: ACHS-3-250
	Resim Picture Рисунок	Takım Kodu Set Code Код Набора	Ürün Açıklaması Product Description Описание товара			
1		AMP-01	M10 Bağlantı Elemanı M10 Fastener Застежка M10	1x	-	-
2		AMP-02	G 1/8" Çift Bağlantı Elemanı G 1/8" Double Fastener G 1/8" двойная застежка	2x	1x	-
3		AMP-03	G 1/8" Açılı Bağlantısı G 1/8" Angle Connection G 1/8" угловое соединение	-	1x	2x
4		AMP-04	M10" Açılı Bağlantısı M10" Angle Connection M10" угловое соединение	-	1x	1x
5		AMP-05	G1/4"-G1/8" Kılcalma Parçası G1 / 4"-G1/8" Capillary Piece G1 / 4"-G1/8" Капиллярная часть	-	1x	1x
6		AG-01	Bakır Conta Copper Gasket Медная прокладка	2x	3x	4x
7		2705-G1/8-5.5	G1/8" Sızdırmaz Civata G1/8" Sealing Bolt G1/8" Уплотнительный болт	1x	1x	1x
8		AH-1-250	Hortum Hose Трубка	1x	-	-
9		AH-2-250	Hortum Hose Трубка	-	1x	-
10		AH-3-250	Hortum Hose Трубка	-	-	1x

M-SİSTEM

M-SİSTEM DIŞ TORNA KATERLERİ
M-SYSTEM EXTERNAL TURNING TOOLHOLDERS
M-ТИП ДЕРЖАВКИ ДЛЯ НАРУЖНОГО ТОЧЕНИЯ

*konusulan
the spoken kalite...
quality...*



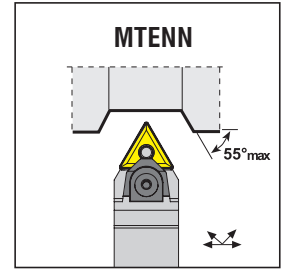
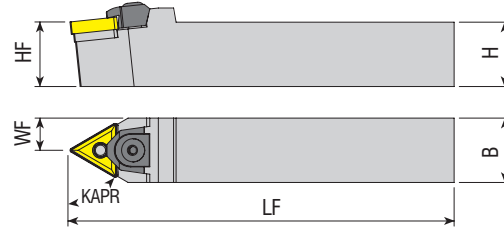

Takım Kodu Ordering Code Код для заказа	Stok Stock Наличие		Takım Ölçüleri (mm) Dimension (mm) Размеры (мм)				Kesici Uç Insert Пластина	Baskı Pabuçu Wedge Clamp Прижим	Pabuç Vidası Clamp Screw Закрепительный винт	Altlık Shim Опорная пластина	Pim Pin Штифт	Segman Ring Кольцо	Pul Stamp Шайба	Anahtar Allen Key Ключ
	●	○	HF=H	B	LF	WF								
MTENN 2020 K16	●		20	20	125	10	TNM. 1604..	AMK-04	AKV-30-M6x22	AATN-2-0002	APM-01	AS-01	ABPL-01	AAL-03-3
2525 M16	●		25	25	150	12.5								
3232 P16	●		32	32	170	16								
2525 M22	●		25	25	150	12.5	TNM. 2204..	AMK-08	AKV-30-M6x22	AATN-3-0015	APM-02	AS-01	ABPL-01	AAL-03-3
3232 P22	●		32	32	170	16								
4040 S22	●		40	40	250	20								

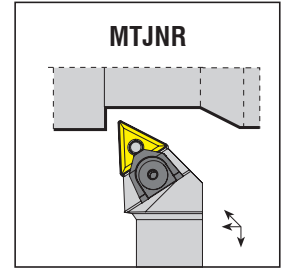
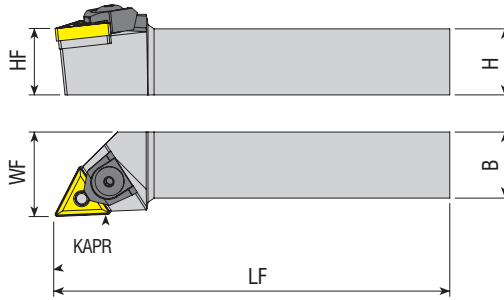
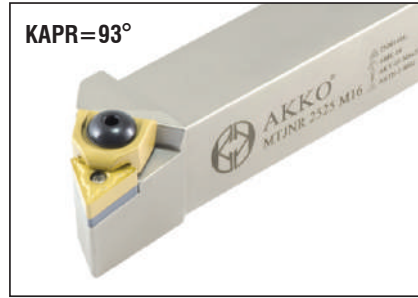

Takım Kodu Ordering Code Код для заказа	Stok Stock Наличие		Takım Ölçüleri (mm) Dimension (mm) Размеры (мм)				Kesici Uç Insert Пластина	Baskı Pabuçu Wedge Clamp Прижим	Pabuç Vidası Clamp Screw Закрепительный винт	Altlık Shim Опорная пластина	Pim Pin Штифт	Segman Ring Кольцо	Pul Stamp Шайба	Anahtar Allen Key Ключ
	R	L	HF=H	B	LF	WF								
MTJNR/L 2020 K16	●	●	20	20	125	25	TNM. 1604..	AMK-04	AKV-30-M6x22	AATN-2-0002	APM-01	AS-01	ABPL-01	AAL-03-3
2525 M16	●	●	25	25	150	32								
3232 P16	●	●	32	32	170	40								
2525 M22	●	●	25	25	150	32	TNM. 2204..	AMK-08	AKV-30-M6x22	AATN-3-0015	APM-02	AS-01	ABPL-01	AAL-03-3
3232 P22	●	●	32	32	170	40								
4040 S22	●	●	40	40	250	50								

R: Sağ / Right / Правый L: Sol / Left / Левый
● Stokta / In Stock / В наличии ○ Stokta Yok / Non Stock Item / Нет в наличии

Sipariş Örneği/Ordering Example/Образец заказа
1 ad./pcs./шт. MTENN 2020 K16

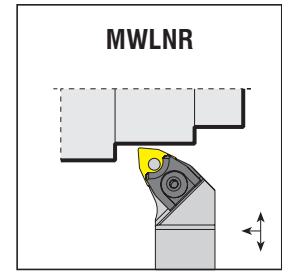
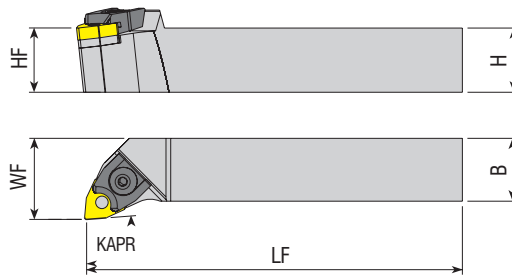

Takım Kodu Ordering Code Код для заказа		Stok Stock Наличие		Takım Ölçüleri (mm) Dimension (mm) Размеры (мм)			Kesici Uç Insert Пластина	Baskı Pabuçu Wedge Clamp Прижим	Pabuç Vidası Clamp Screw Зажимной винт	Altık Shim Оторная пластина	Pim Pin Штифт	Segman Ring Кольцо	Pul Stamp Шайба	Anahtar Allen Key Ключ	
		R	L	HF=H	B	LF									WF
MWLNR/L	1616 H06	●	●	16	16	100	20	WNM. 0604..	AMK-01	AKV-04-M5x17	-	APM-08	-	-	AAL-03-3
	2020 K06	●	●	20	20	125	25								
	2525 M06	●	●	25	25	150	32								
	2020 K08	●	●	20	20	125	25	WNM. 0804..	AMK-05	AKV-03-M6x22	AAWN-3-0001	APM-02	AS-01	ABPL-01	
	2525 M08	●	●	25	25	150	32								
	3232 P08	●	●	32	32	170	40								

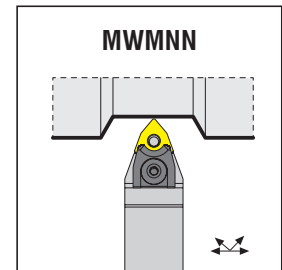
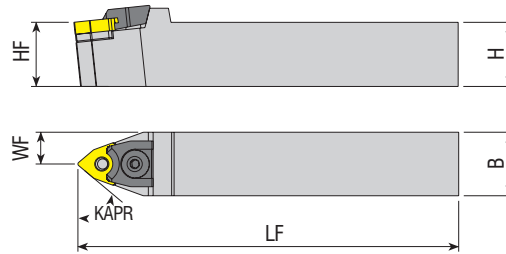

Takım Kodu Ordering Code Код для заказа		Stok Stock Наличие		Takım Ölçüleri (mm) Dimension (mm) Размеры (мм)			Kesici Uç Insert Пластина	Baskı Pabuçu Wedge Clamp Прижим	Pabuç Vidası Clamp Screw Зажимной винт	Altık Shim Оторная пластина	Pim Pin Штифт	Segman Ring Кольцо	Pul Stamp Шайба	Anahtar Allen Key Ключ	
		R	L	HF=H	B	LF									WF
MWMNN	1616 H06	●	●	16	16	100	8	WNM. 0604..	AMK-01	AKV-04-M5x17	-	APM-08	-	-	AAL-03-3
	2020 K06	●	●	20	20	125	10								
	2525 M06	●	●	25	25	150	12.5								
	2020 K08	●	●	20	20	125	10	WNM. 0804..	AMK-05	AKV-03-M6x22	AAWN-3-0001	APM-02	AS-01	ABPL-01	
	2525 M08	●	●	25	25	150	12.5								
	3232 P08	●	●	32	32	170	16								

R: Sağ / Right / Правый L: Sol / Left / Левый
● Stokta / In Stock / В наличии ○ Stokta Yok / Non Stock Item / Нет в наличии

Sipariş Örneği/Ordering Example/Образец заказа
1 ad./pcs./шт. MWLNR 1616 H06



*konusulan
the spoken kalite...
quality...*

P-SİSTEM

P-SİSTEM DIŞ TORNA KATERLERİ
P-SYSTEM EXTERNAL TURNING TOOLHOLDERS
P-ТИП ДЕРЖАВКИ ДЛЯ НАРУЖНОГО ТОЧЕНИЯ

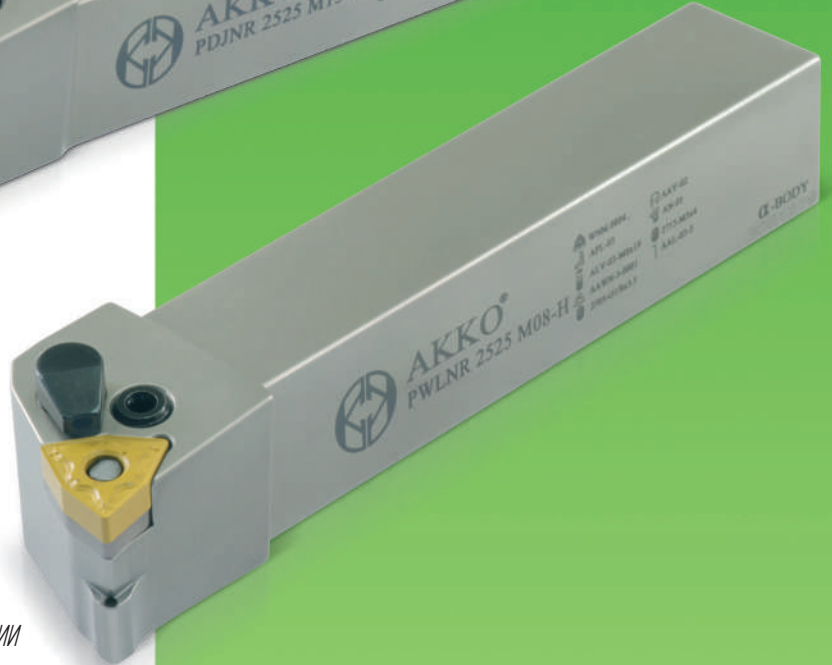
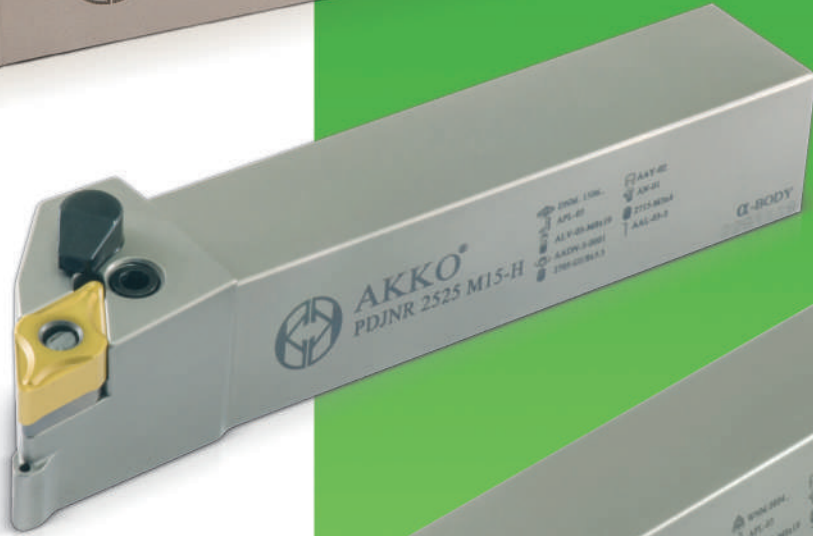

DETAYLI BİLGİ İÇİN BARKODU OKUTUNUZ

SCAN ME FOR MORE DETAILS

ПРОСКАНИРУЙТЕ ДЛЯ ПОЛУЧЕНИЯ БОЛЕЕ ПОДРОБНОЙ ИНФОРМАЦИИ

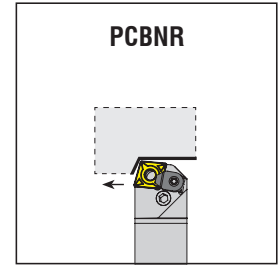
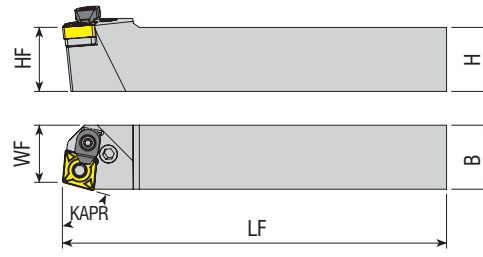

Takım Kodu
Ordering Code
Код для заказа

Takım Kodu Ordering Code Код для заказа	Stok Stock Наличие		Takım Ölçüleri (mm) Dimension (mm) Размеры (мм)				Kesici Uç Insert Пластина	Yedek Parçaları / Spare Parts / Запасные части						
	R	L	HF=H	B	LF	WF		Levyeye Lever Рычаг	Levyeye Vidası Lever Screw Винт рычага	Altılık Shim Отпорная пластина	Altılık Yayı Shim Spring Буфта рычага	Baskı Parçası Wedge Clamp Прижим	Baskı Vidası Clamp Screw Зажимной винт	Anahtar Allen Key Ключ
PCBNR/L 2020 K12C	●	●	20	20	125	17.5	CNM. 1204..	APL-02	ALV-03-M8x19	AACN-3-0001	AAY-02	ACK-05	4015-M4x11	AAL-03-3
2525 M12C	●	●	25	25	150	22.5								
3232 P12C	●	●	32	32	170	29.5								
2525 M16C	●	●	25	25	150	22	CNM. 1606..	APL-04	ALV-04-M8x22	AACN-3-0002	AAY-03	ACK-09	AAV-05-M6x15	AAL-05-4
3232 P16C	●	●	32	32	170	27								
3232 P19C	●	●	32	32	170	27	CNM. 1906..	APL-05	ALV-05-M10x27	AACN-3-0003	AAY-04	ACK-09	AAV-05-M6x15	AAL-05-4
4040 S19C	●	●	40	40	250	37								
4040 S25C	●	●	40	40	250	37	CNM. 2509..	APL-06	ALV-06-M12x36	AACN-3-0008	AAY-05	ACK-04	AKV-16-M6x16	AAL-07-5
5050 S25C	○	○	50	50	250	47								

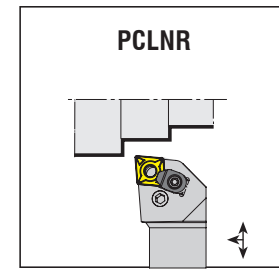
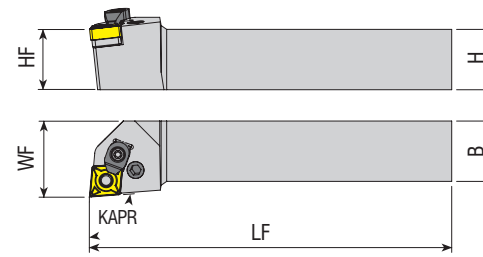

Takım Kodu
Ordering Code
Код для заказа

Takım Kodu Ordering Code Код для заказа	Stok Stock Наличие		Takım Ölçüleri (mm) Dimension (mm) Размеры (мм)				Kesici Uç Insert Пластина	Yedek Parçaları / Spare Parts / Запасные части						
	R	L	HF=H	B	LF	WF		Levyeye Lever Рычаг	Levyeye Vidası Lever Screw Винт рычага	Altılık Shim Отпорная пластина	Altılık Yayı Shim Spring Буфта рычага	Baskı Parçası Wedge Clamp Прижим	Baskı Vidası Clamp Screw Зажимной винт	Anahtar Allen Key Ключ
PCLNR/L 1616 H09	●	●	16	16	100	20	CNM. 0903..	APL-01	ALV-02-M6x17	AACN-2-0002	AAY-01	-	-	AAL-02-2.5
2020 K09	●	●	20	20	125	25								
2525 M09	●	●	25	25	150	32								
1616 H12	●	●	16	16	100	20	CNM. 1204..	APL-02	ALV-03-M8x19	AACN-3-0001	AAY-02	ACK-05	4015-M4x11	AAL-03-3
2020 K12C	●	●	20	20	125	25								
2525 M12C	●	●	25	25	150	32								
3232 P12C	●	●	32	32	170	40	CNM. 1606..	APL-04	ALV-04-M8x22	AACN-3-0002	AAY-03	ACK-09	AAV-05-M6x15	AAL-05-4
2525 M16C	●	●	25	25	150	32								
3232 P16C	●	●	32	32	170	40	CNM. 1906..	APL-05	ALV-05-M10x27	AACN-3-0003	AAY-04	ACK-09	AAV-05-M6x15	AAL-05-4
2525 M19C	●	●	25	25	150	32								
3232 P19C	●	●	32	32	170	40	CNM. 2509..	APL-06	ALV-06-M12x36	AACN-3-0008	AAY-05	ACK-04	AKV-16-M6x16	AAL-07-5
4040 S19C	●	●	40	40	250	50								
4040 S25C	●	●	40	40	250	50								
5050 S25C	●	●	50	50	250	60								

R: Sağ / Right / Правый L: Sol / Left / Левый

● Stokta / In Stock / В наличии ○ Stokta Yok / Non Stock Item / Нет в наличии

Sipariş Örneği/Ordering Example/Образец заказа
1 ad./pcs./шт. PCBNR 2020 K12C

P-SİSTEM DIŞ TORNA KATERLERİ
P-SYSTEM EXTERNAL TURNING TOOLHOLDERS
P-ТИП ДЕРЖАВКИ ДЛЯ НАРУЖНОГО ТОЧЕНИЯ

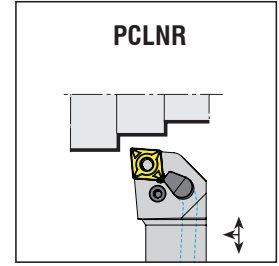
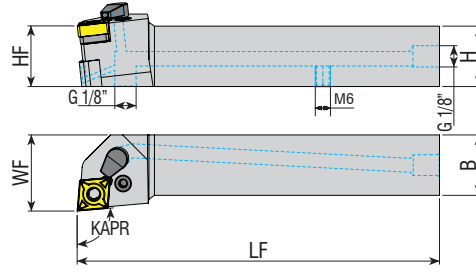

Takım Kodu Ordering Code Код для заказа	Stok Stock Наличие		Takım Ölçüleri (mm) Dimension (mm) Размеры (мм)				Kesici Uç Insert Пластина	Yedek Parçaları / Spare Parts / Запасные части															
	R	L	HF=H	B	LF	WF		Levyeye Lever Рычаг	Levyeye Vidası Lever Screw Винт рычага	Altılık Shim Опорная пластина	Altılık Yayı Shim Spring Втулка рычага	Oring Ring Кольцо	Sızdırmaz Vida Threaded Pin Резьбовой Винт	Nozul Nozzle Триггер СОЖ	Anahtar Allen Key Ключ								
PCLNR/L 2020 K12-H	●	●	20	20	125	25	CNM. 1204..	APL-02	ALV-03-M8x19	AACN-3-0001	AAY-02	AXR-01 AOR-01	2705-G1/8x5.5	AN-01	AAL-03-3								
2525 M12-H	●	●	25	25	150	32																	
3232 P12-H	●	○	32	32	170	40																	
3232 P16-H	●	○	32	32	170	40										CNM. 1606..	APL-04	ALV-04-M8x22	AACN-3-0002	AAY-03			
3232 P19-H	●	○	32	32	170	40										CNM. 1906..	APL-05	ALV-05-M10x27	AACN-3-0003	AAY-04			AAL-03-4

VDI tutucu ile uyumludur. / Compatible with VDI holders. / degisecekmemogurdall demo

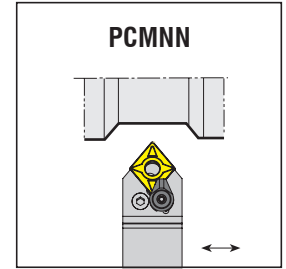
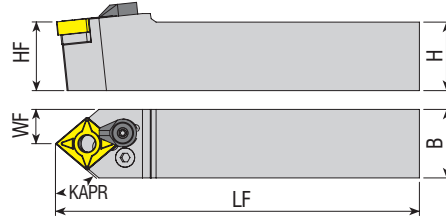

Takım Kodu Ordering Code Код для заказа	Stok Stock Наличие		Takım Ölçüleri (mm) Dimension (mm) Размеры (мм)				Kesici Uç Insert Пластина	Yedek Parçaları / Spare Parts / Запасные части									
	R	L	HF=H	B	LF	WF		Levyeye Lever Рычаг	Levyeye Vidası Lever Screw Винт рычага	Altılık Shim Опорная пластина	Altılık Yayı Shim Spring Втулка рычага	Baskı Parçası Wedge Clamp Прижим	Baskı Vidası Clamp Screw Зажимной винт	Anahtar Allen Key Ключ			
PCMNN 2020 K12C	●	●	20	20	125	10	CNM. 1204..	APL-02	ALV-03-M8x19	AACN-3-0001	AAY-02	ACK-05	4015-M4x11	AAL-03-3			
2525 M12C	●	●	25	25	150	12.5											
3232 P12C	○	○	32	32	170	16											
2525 M16C	○	○	25	25	150	12.5	CNM. 1606..	APL-04	ALV-04-M8x22	AACN-3-0002	AAY-03						
3232 P16C	○	○	32	32	170	16											
3232 P19C	●	●	32	32	170	16	CNM. 1906..	APL-05	ALV-05-M10x27	AACN-3-0003	AAY-04	ACK-09	AAV-05-M6x15	AAL-05-4			
4040 S19C	●	●	40	40	250	20											
5050 S19C	○	○	50	50	250	25											
4040 S25C	●	●	40	40	250	20	CNM. 2509..	APL-06	ALV-06-M12x36	AACN-3-0008	AAY-05	ACK-04	AKV-16-M6x16	AAL-07-5			

R: Sağ / Right / Правый L: Sol / Left / Левый

● Stokta / In Stock / В наличии ○ Stokta Yok / Non Stock Item / Нет в наличии

Sipariş Örneği/Ordering Example/Образец заказа

1 ad./pcs./шт. PCLNR 2020 K12-H



www.akkо.com.tr

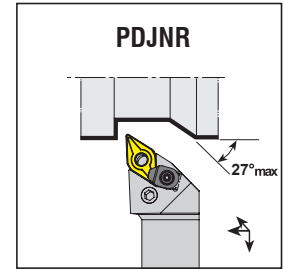
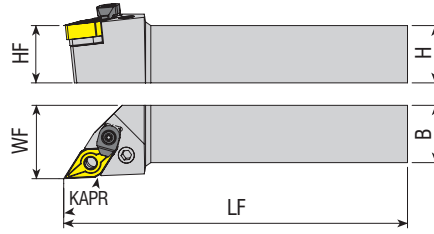

Takım Kodu Ordering Code Код для заказа	Stok Stock Наличие		Takım Ölçüleri (mm) Dimension (mm) Размеры (мм)				Kesici Uç Insert Пластина	Yedek Parçaları / Spare Parts / Запасные части							
	R	L	HF=H	B	LF	WF		Levye Lever Рычаг	Levye Vidası Lever Screw Винт рычага	Altık Shim Oпорная пластина	Altık Yay Shim Spring Втулка рычага	Baskı Parçası Wedge Clamp Прижим	Baskı Vidası Clamp Screw Зажимной винт	Anahtar Allen Key Ключ	
	●	○													
PDJNR/L 1616 H11	●	●	16	16	100	20	DNM. 1104..	APL-01	ALV-02-M6x17	AADN-SD317	AAY-01	-	-	AAL-02-2.5	
2020 K11	●	●	20	20	125	25									
2525 M11	●	●	25	25	150	32									
2020 K15C	●	●	20	20	125	25									
2525 M15C	●	●	25	25	150	32	DNM. 1506..	APL-03	ALV-03-M8x19	AADN-3-0001	AAY-02	ACK-05	4015-M4x11	AAL-03-3	
3232 P15C	●	●	32	32	170	40									
4040 S15C	●	●	40	40	250	50									

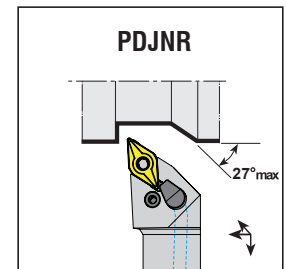
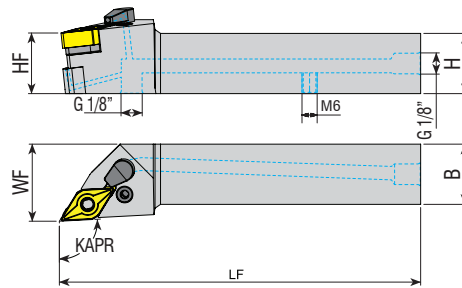

Takım Kodu Ordering Code Код для заказа	Stok Stock Наличие		Takım Ölçüleri (mm) Dimension (mm) Размеры (мм)				Kesici Uç Insert Пластина	Yedek Parçaları / Spare Parts / Запасные части									
	R	L	HF=H	B	LF	WF		Levye Lever Рычаг	Levye Vidası Lever Screw Винт рычага	Altık Shim Oпорная пластина	Altık Yay Shim Spring Втулка рычага	Oring Ring Кольцо	Sızdırmaz Vida Threaded Pin Резьбовой Винт	Nozul Nozzle Прижим СОЖ	Anahtar Allen Key Ключ		
	●	○															
PDJNR/L 2020 K15-H	●	●	20	20	125	25	DNM. 1506..	APL-03	ALV-03-M8x19	AADN-3-0001	AAY-02	AXR-01 AOR-01	2705-G1/8x5.5	AN-01	AAL-03-3		
2525 M15-H	●	●	25	25	150	32											
3232 P15-H	●	○	32	32	170	40											

R: Sağ / Right / Правый L: Sol / Left / Левый
● Stokta / In Stock / В наличии ○ Stokta Yok / Non Stock Item / Нет в наличии
VDI tutucu ile uyumludur. / Compatible with VDI holders. / degisecekmemogurdall demo

Sipariş Örneği/Ordering Example/Образец заказа
1 ad./pcs./шт. PDJNR 1616 H11

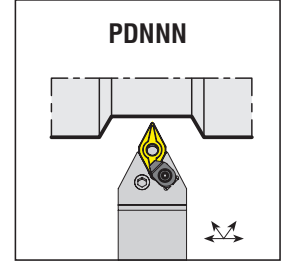
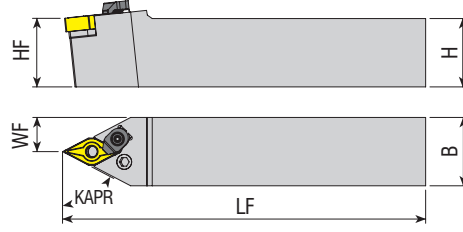

Takım Kodu Ordering Code Код для заказа	Stok Stock Наличие	Takım Ölçüleri (mm) Dimension (mm) Размеры (мм)				Kesici Uç Insert Пластина	Yedek Parçaları / Spare Parts / Запасные части								
		HF=H	B	LF	WF		Levye Lever Рычаг	Levye Vidası Lever Screw Винт рычага	Aitlik Shim Опорная пластина	Aitlik Yayı Shim Spring Втулка рычага	Baskı Parçası Wedge Clamp Прижим	Baskı Vidası Clamp Screw Зажимной винт	Anahtar Allen Key Ключ		
PDNNN 1616 H11	●	16	16	100	8										
2020 K11	●	20	20	125	10	DNM. 1104..	APL-01	ALV-02-M6x17	AADN-SD317	AAY-01	-	-	AAL-02-2.5		
2525 M11	●	25	25	150	12.5										
2020 K15C	●	20	20	125	10										
2525 M15C	●	25	25	150	12.5	DNM. 1506..	APL-03	ALV-03-M8x19	AADN-3-0001	AAY-02	ACK-05	4015-M4x11	AAL-03-3		
3232 P15C	●	32	32	170	16										

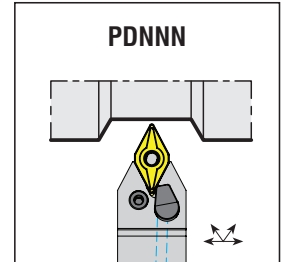
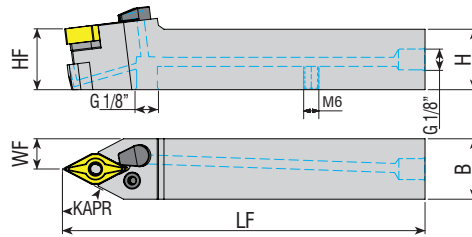

Takım Kodu Ordering Code Код для заказа	Stok Stock Наличие	Takım Ölçüleri (mm) Dimension (mm) Размеры (мм)				Kesici Uç Insert Пластина	Yedek Parçaları / Spare Parts / Запасные части									
		HF=H	B	LF	WF		Levye Lever Рычаг	Levye Vidası Lever Screw Винт рычага	Aitlik Shim Опорная пластина	Aitlik Yayı Shim Spring Втулка рычага	Oring Ring Кольцо	Sızdırmaz Vida Threaded Pin Резьбовой Винт	Nozul Nozzle Прижим СОЖ	Anahtar Allen Key Ключ		
PDNNN 2525 M15-H	●	25	25	150	32	DNM. 1506..	APL-03	ALV-03-M8x19	AADN-3-0001	AAY-02	AXR-01 AOR-01	2705-G1/8x5.5	AN-01	AAL-03-3		

R: Sağ / Right / Правый L: Sol / Left / Левый

● Stokta / In Stock / В наличии ○ Stokta Yok / Non Stock Item / Нет в наличии

VDI tutucu ile uyumludur. / Compatible with VDI holders. / degisecekmemogurdall demo

Sipariş Örneği/Ordering Example/Образец заказа

1 ad./pcs./шт. PDNNN 1616 H11

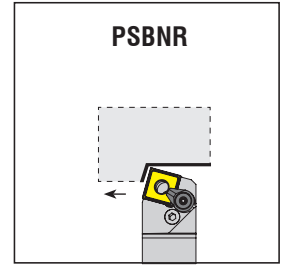
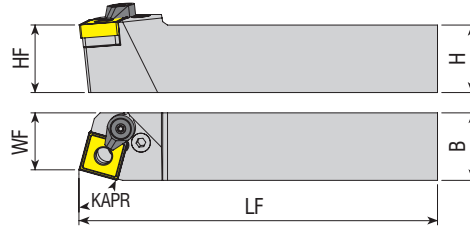

Takım Kodu Ordering Code Код для заказа	Stok Stock Наличие		Takım Ölçüleri (mm) Dimension (mm) Размеры (мм)				Kesici Uç Insert Пластина	Yedek Parçaları / Spare Parts / Запасные части						
	R	L	HF=H	B	LF	WF		Levyeye Lever Рычаг	Levyeye Vidası Lever Screw Винт рычага	Altılık Shim Опорная пластина	Altılık Yay Shim Spring Втулка рычага	Baskı Parçası Wedge Clamp Прижим	Baskı Vidası Clamp Screw Зажимной винт	Anahtar Allen Key Ключ
	●	○												
PSBNR/L 1616 H09	●	●	16	16	100	13	SNM. 0903..	APL-01	ALV-02-M6x17	AASN-2-0002	AAY-01	-	-	AAL-02-2.5
2020 K09	○	○	20	20	125	17						-	-	
2020 K12	●	●	20	20	125	17						-	-	
2525 M12C	●	●	25	25	150	22	SNM. 1204..	APL-02	ALV-03-M8x19	AASN-3-0004	AAY-02	ACK-05	4015-M4x11	AAL-03-3
3232 P12C	●	●	32	32	170	27								
2525 M15	●	●	25	25	150	22	SNM. 1506..	APL-04	ALV-04-M8x22	AASN-3-0023	AAY-03	-	-	AAL-05-4
3232 P15C	●	●	32	32	170	27								
3232 P19C	●	●	32	32	170	27	SNM. 1906..	APL-05	ALV-05-M10x27	AASN-3-0005	AAY-04	ACK-09	AAV-05-M6x15	AAL-05-4
4040 S19C	●	●	40	40	250	35								
4040 S25C	●	●	40	40	250	35	SNM. 2509..	APL-06	ALV-06-M12x36	AASN-3-0020	AAY-05	ACK-04	AKV-16-M6x16	AAL-07-5
5050 S25C	●	○	50	50	250	43								

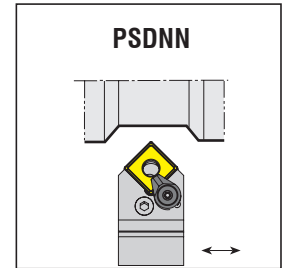
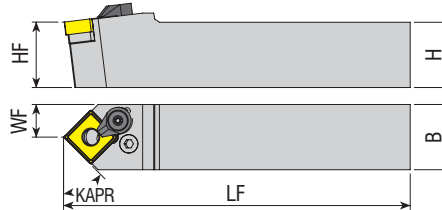

Takım Kodu Ordering Code Код для заказа	Stok Stock Наличие		Takım Ölçüleri (mm) Dimension (mm) Размеры (мм)				Kesici Uç Insert Пластина	Yedek Parçaları / Spare Parts / Запасные части						
	R	L	HF=H	B	LF	WF		Levyeye Lever Рычаг	Levyeye Vidası Lever Screw Винт рычага	Altılık Shim Опорная пластина	Altılık Yay Shim Spring Втулка рычага	Baskı Parçası Wedge Clamp Прижим	Baskı Vidası Clamp Screw Зажимной винт	Anahtar Allen Key Ключ
	●	○												
PSDNN 1616 H09	●	●	16	16	100	8	SNM. 0903..	APL-01	ALV-02-M6x17	AASN-2-0002	AAY-01	-	-	AAL-02-2.5
2020 K12C	●	●	20	20	125	10						-	-	
2525 M12C	●	●	25	25	150	12.5						SNM. 1204..	APL-02	
3232 P12C	●	●	32	32	170	16								
2020 K15	●	●	20	20	125	10	SNM. 1506..	APL-04	ALV-04-M8x22	AASN-3-0023	AAY-03	-	-	AAL-05-4
2525 M15C	●	●	25	25	150	12.5								
3232 P19C	●	●	32	32	170	16	SNM. 1906..	APL-05	ALV-05-M10x27	AASN-3-0005	AAY-04	ACK-09	AAV-05-M6x15	AAL-05-4
4040 S19C	○	○	40	40	250	20								
5050 S19C	○	○	50	50	250	25	SNM. 2509..	APL-06	ALV-06-M12x36	AASN-3-0020	AAY-05	ACK-04	AKV-16-M6x16	AAL-07-5
4040 S25C	●	●	40	40	250	20								
5050 S25C	○	○	50	50	250	25								

R: Sağ / Right / Правый L: Sol / Left / Левый
● Stokta / In Stock / В наличии ○ Stokta Yok / Non Stock Item / Нет в наличии

Sipariş Örneği/Ordering Example/Образец заказа
1 ad./pcs./шт. PSBNR 1616 H09

P-SİSTEM DIŞ TORNA KATERLERİ
P-SYSTEM EXTERNAL TURNING TOOLHOLDERS
P-ТИП ДЕРЖАВКИ ДЛЯ НАРУЖНОГО ТОЧЕНИЯ

KAPR=75°

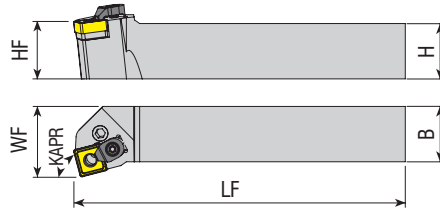

PSKNR

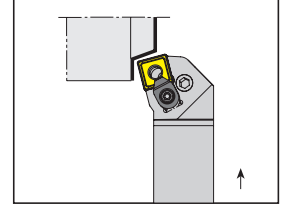

Takım Kodu Ordering Code Код для заказа	Stok Stock Наличие		Takım Ölçüleri (mm) Dimension (mm) Размеры (мм)				Kesici Uç Insert Пластина	Yedek Parçaları / Spare Parts / Запасные части								
	R	L	HF=H	B	LF	WF		Levyeye Lever Рычаг	Levyeye Vidası Lever Screw Винт рычага	Aitlik Shim Опорная пластина	Aitlik Yayı Shim Spring Втулка рычага	Baskı Parçası Wedge Clamp Прижим	Baskı Vidası Clamp Screw Зажимной винт	Anahtar Allen Key Ключ		
	●	○														
PSKNR/L 2020 K09	●	○	20	20	125	25	SNM. 0903..	APL-01	ALV-02-M6x17	AASN-2-0002	AAV-01	-	-	AAL-02-2.5		
2020 K12C	●	●	20	20	125	25										
2525 M12C	●	●	25	25	150	32	SNM. 1204..	APL-02	ALV-03-M8x19	AASN-3-0004	AAV-02	ACK-05	4015-M4x11	AAL-03-3		
3232 P12C	●	●	32	32	170	40										
2525 M15C	●	●	25	25	150	32	SNM. 1506..	APL-04	ALV-04-M8x22	AASN-3-0023	AAV-03					
3232 P15C	●	●	32	32	170	40										
3232 P19C	●	●	32	32	170	40	SNM. 1906..	APL-05	ALV-05-M10x27	AASN-3-0005	AAV-04	ACK-09	AAV-05-M6x15	AAL-05-4		
4040 S19C	●	●	40	40	250	50										
4040 S25C	●	●	40	40	250	50	SNM. 2509..	APL-06	ALV-06-M12x36	AASN-3-0020	AAV-05	ACK-04	AKV-16-M6x16	AAL-07-5		
5050 S25C	●	○	50	50	250	60										

KAPR=45°

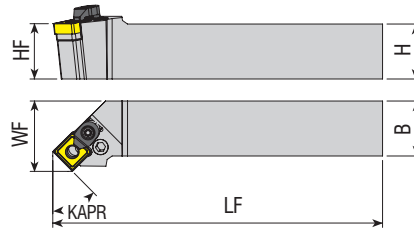

PSSNR

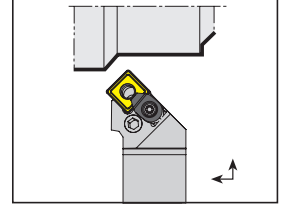

Takım Kodu Ordering Code Код для заказа	Stok Stock Наличие		Takım Ölçüleri (mm) Dimension (mm) Размеры (мм)				Kesici Uç Insert Пластина	Yedek Parçaları / Spare Parts / Запасные части								
	R	L	HF=H	B	LF	WF		Levyeye Lever Рычаг	Levyeye Vidası Lever Screw Винт рычага	Aitlik Shim Опорная пластина	Aitlik Yayı Shim Spring Втулка рычага	Baskı Parçası Wedge Clamp Прижим	Baskı Vidası Clamp Screw Зажимной винт	Anahtar Allen Key Ключ		
	●	○														
PSSNR/L 1616 H09	●	●	16	16	100	20	SNM. 0903..	APL-01	ALV-02-M6x17	AASN-2-0002	AAV-01	-	-	AAL-02-2.5		
2020 K09	●	○	20	20	125	25										
2020 K12C	●	●	20	20	125	25										
2525 M12C	●	●	25	25	150	32	SNM. 1204..	APL-02	ALV-03-M8x19	AASN-3-0004	AAV-02	ACK-05	4015-M4x11	AAL-03-3		
3232 P12C	●	●	32	32	170	40										
3232 P15C	●	○	32	32	170	40	SNM. 1506..	APL-04	ALV-04-M8x22	AASN-3-0023	AAV-03					
3232 P19C	●	●	32	32	170	40	SNM. 1906..	APL-05	ALV-05-M10x27	AASN-3-0005	AAV-04	ACK-09	AAV-05-M6x15	AAL-05-4		
4040 S19C	●	●	40	40	250	50										
4040 S25C	●	●	40	40	250	50	SNM. 2509..	APL-06	ALV-06-M12x36	AASN-3-0020	AAV-05	ACK-04	AKV-16-M6x16	AAL-07-5		

R: Sağ / Right / Правый L: Sol / Left / Левый
● Stokta / In Stock / В наличии ○ Stokta Yok / Non Stock Item / Нет в наличии

Sipariş Örneği/Ordering Example/Образец заказа
1 ad./pcs./шт. PSKNR 2020 K09



www.akkо.com.tr

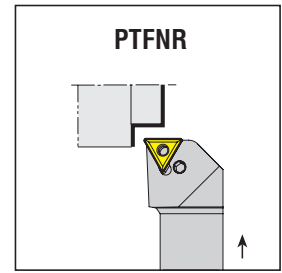
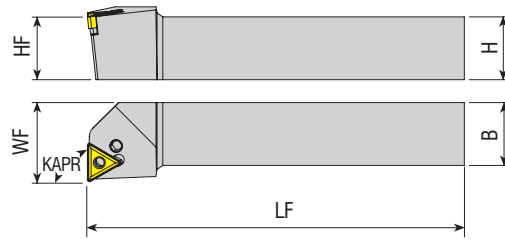

Takım Kodu Ordering Code Код для заказа	Stok Stock Наличие		Takım Ölçüleri (mm) Dimension (mm) Размеры (мм)				Kesici Uç Insert Пластина	Yedek Parçaları / Spare Parts / Запасные части						
	R	L	HF=H	B	LF	WF		Levyeye Lever Рычаг	Levyeye Vidası Lever Screw Винт рычага	Aitlik Shim Опорная пластина	Aitlik Yay Shim Spring Втулка рычага	Baskı Parçası Wedge Clamp Прижим	Baskı Vidası Clamp Screw Зажимной винт	Anahtar Allen Key Ключ
PTFNR/L 1616 H16	●	●	16	16	100	20	TNM. 1604..	APL-01	ALV-02-M6x17	AATN-3-0025	AAV-01	-	-	AAL-02-2.5
2020 K16	●	●	20	20	125	25								
2525 M16	●	●	25	25	150	32								
3232 P16	●	●	32	32	170	40								
2525 M22C	●	●	25	25	150	32	TNM. 2204..	APL-02	ALV-03-M8x19	AATN-3-0015	AAV-02	ACK-05	4015-M4x11	AAL-03-3
3232 P22C	●	●	32	32	170	40								
4040 S27C	○	○	40	40	250	50	TNM. 2706..	APL-04	ALV-04-M8x22	AATN-3-0027	AAV-03	ACK-09	AAV-05-M6x15	AAL-03-3

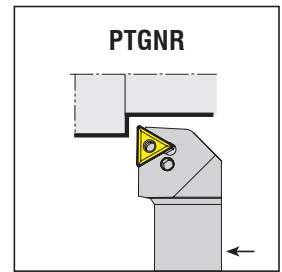
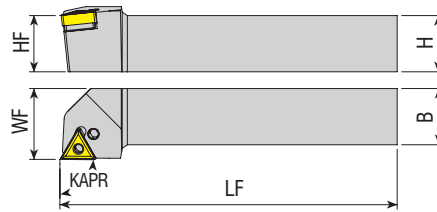

Takım Kodu Ordering Code Код для заказа	Stok Stock Наличие		Takım Ölçüleri (mm) Dimension (mm) Размеры (мм)				Kesici Uç Insert Пластина	Yedek Parçaları / Spare Parts / Запасные части						
	R	L	HF=H	B	LF	WF		Levyeye Lever Рычаг	Levyeye Vidası Lever Screw Винт рычага	Aitlik Shim Опорная пластина	Aitlik Yay Shim Spring Втулка рычага	Baskı Parçası Wedge Clamp Прижим	Baskı Vidası Clamp Screw Зажимной винт	Anahtar Allen Key Ключ
PTGNR/L 1010 E11	○	○	10	10	70	12	TNM. 1103..	APL-11	ALV-10-M5x10	-	-	-	-	AAL-13-2.5
1212 F11	○	○	12	12	80	16								
1616 H11	○	○	16	16	100	20								
1616 H16	●	●	16	16	100	20	TNM. 1604..	APL-01	ALV-02-M6x17	AATN-3-0025	AAV-01	-	-	AAL-02-2.5
2020 K16	●	●	20	20	125	25								
2525 M16	●	●	25	25	150	32								
3232 P16	○	○	32	32	170	40								
2525 M22C	●	●	25	25	150	32	TNM. 2204..	APL-02	ALV-03-M8x19	AATN-3-0015	AAV-02	ACK-05	4015-M4x11	AAL-03-3
3232 P22C	●	●	32	32	170	40								
4040 S27C	○	○	40	40	250	50	TNM. 2706..	APL-04	ALV-04-M8x22	AATN-3-0027	AAV-03	ACK-09	AAV-05-M6x15	AAL-03-3

R: Sağ / Right / Правый L: Sol / Left / Лезый
● Stokta / In Stock / В наличии ○ Stokta Yok / Non Stock Item / Нет в наличии

Sipariş Örneği/Ordering Example/Образец заказа
1 ad./pcs./шт. PTFNR 1616 H16

➤ P-SİSTEM DIŞ TORNA KATERLERİ
P-SYSTEM EXTERNAL TURNING TOOLHOLDERS
P-ТИП ДЕРЖАВКИ ДЛЯ НАРУЖНОГО ТОЧЕНИЯ

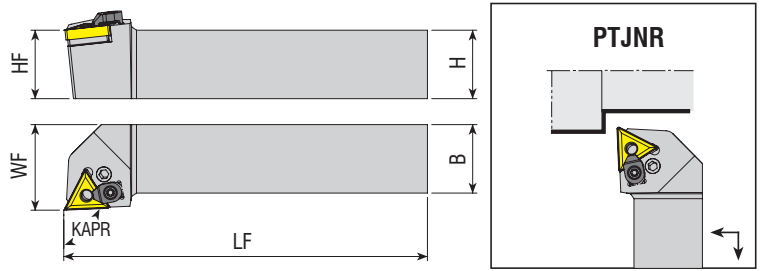

Takım Kodu Ordering Code Код для заказа	Stok Stock Наличие		Takım Ölçüleri (mm) Dimension (mm) Размеры (мм)				Kesici Uç Insert Пластина	Yedek Parçaları / Spare Parts / Запасные части						
	R	L	HF=H	B	LF	WF		Levye Lever Рычаг	Levye Vidası Lever Screw Винт рычага	Altılık Shim Опорная пластина	Altılık Yay Shim Spring Втулка рычага	Baskı Parçası Wedge Clamp Прижим	Baskı Vidası Clamp Screw Зажимной винт	Anahtar Allen Key Ключ
	○	○												
PTJNR/L 1010 E11	○	○	10	10	70	12	TNM. 1103..			-	-	-	-	AAL-13-2.5
1212 F11	○	○	12	12	80	16								
1616 H11	○	○	16	16	100	20								
1616 H16	●	●	16	16	100	20								
2020 K16	●	●	20	20	125	25	TNM. 1604..			AATN-3-0025	AAY-01	-	-	AAL-02-2.5
2525 M16	●	●	25	25	150	32								
3232 P16	●	●	32	32	170	40								
2525 M22C	●	●	25	25	150	32	TNM. 2204..			AATN-3-0015	AAY-02	ACK-05	4015-M4x11	AAL-03-3
3232 P22C	●	●	32	32	170	40								
4040 S27C	●	○	40	40	250	50	TNM. 2706..			AATN-3-0027	AAY-03	ACK-09	AAV-05-M6x15	AAL-03-3

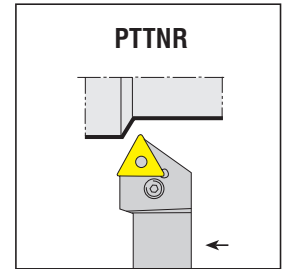
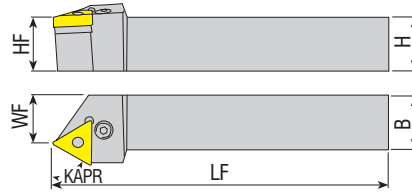

Takım Kodu Ordering Code Код для заказа	Stok Stock Наличие		Takım Ölçüleri (mm) Dimension (mm) Размеры (мм)				Kesici Uç Insert Пластина	Yedek Parçaları / Spare Parts / Запасные части						
	R	L	HF=H	B	LF	WF		Levye Lever Рычаг	Levye Vidası Lever Screw Винт рычага	Altılık Shim Опорная пластина	Altılık Yay Shim Spring Втулка рычага	Baskı Parçası Wedge Clamp Прижим	Baskı Vidası Clamp Screw Зажимной винт	Anahtar Allen Key Ключ
	○	○												
PTTNR/L 1616 H16	●	●	16	16	100	13	TNM. 1604..			AATN-3-0025	AAY-01	-	-	AAL-02-2.5
2020 K16	●	●	20	20	125	17								
2525 M16	●	●	25	25	150	21.5								
3232 P16	●	●	32	32	170	31								
2525 M22C	●	●	25	25	150	20.5	TNM. 2204..			AATN-3-0015	AAY-02	ACK-05	4015-M4x11	AAL-03-3
3232 P22C	●	●	32	32	170	29								

R: Sağ / Right / Правый L: Sol / Left / Левый
● Stokta / In Stock / В наличии ○ Stokta Yok / Non Stock Item / Нет в наличии

Sipariş Örneği/Ordering Example/Образец заказа
1 ad./pcs./шт. PTJNR 1010 E11

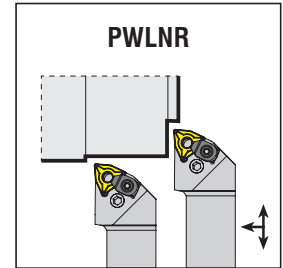
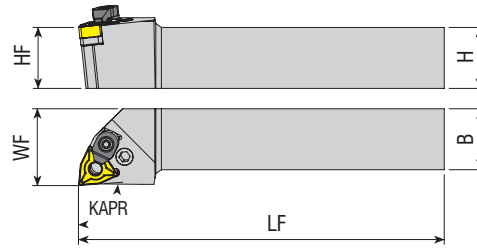

Takım Kodu Ordering Code Код для заказа	Stok Stock Наличие		Takım Ölçüleri (mm) Dimension (mm) Размеры (мм)				Kesici Uç Insert Пластина	Yedek Parçaları / Spare Parts / Запасные части						
	R	L	HF=H	B	LF	WF		Levye Lever Рычаг	Levye Vidası Lever Screw Винт рычага	Altık Shim Опорная пластина	Altık Yayı Shim Spring Втулка рычага	Baskı Parçası Wedge Clamp Прижим	Baskı Vidası Clamp Screw Зажимной винт	Anahtar Allen Key Ключ
	●	○												
PWNLR/L 1616 H06	●	●	16	16	100	20	WNM. 0604..	APL-01	ALV-02-M6x17	AAWN-SW317	AAY-01	-	-	AAL-02-2.5
2020 K06	●	●	20	20	125	25								
2525 M06	●	●	25	25	150	32								
3232 P06	○	○	32	32	170	40								
1616 H08	●	●	16	16	100	20	WNM. 0804..	APL-02	ALV-03-M8x19	AAWN-3-0001	AAY-02	ACK-05	4015-M4x11	AAL-03-3
2020 K08C	●	●	20	20	125	25								
2525 M08C	●	●	25	25	150	32								
3232 P08C	●	●	32	32	170	40								

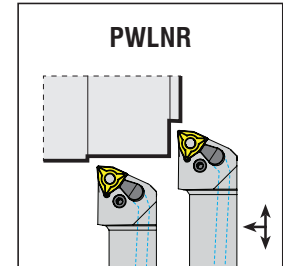
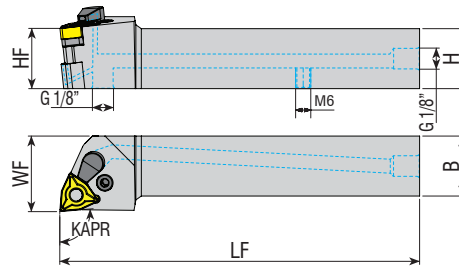

Takım Kodu Ordering Code Код для заказа	Stok Stock Наличие		Takım Ölçüleri (mm) Dimension (mm) Размеры (мм)				Kesici Uç Insert Пластина	Yedek Parçaları / Spare Parts / Запасные части								
	R	L	HF=H	B	LF	WF		Levye Lever Рычаг	Levye Vidası Lever Screw Винт рычага	Altık Shim Опорная пластина	Altık Yayı Shim Spring Втулка рычага	Oring Ring Кольцо	Sızdırmaz Vida Threaded Pin Резьбовой Винт	Nozul Nozzle Прижим СОЖ	Anahtar Allen Key Ключ	
	●	○														
PWNLR/L 2020 K08-H	●	●	20	20	125	25	WNM. 0804..	APL-02	ALV-03-M8x19	AAWN-3-0001	AAY-02	AXR-01	2705-G1/8x5.5	AN-01	AAL-03-3	
2525 M08-H	●	●	25	25	150	32						AOR-01				

R: Sağ / Right / Правый L: Sol / Left / Левый

● Stokta / In Stock / В наличии ○ Stokta Yok / Non Stock Item / Нет в наличии

VDI tutucu ile uyumludur. / Compatible with VDI holders. / degisecekmemogurdall demo

Sipariş Örneği/Ordering Example/Образец заказа

1 ad./pcs./шт. PWNLR 1616 H06



KAPR=93°

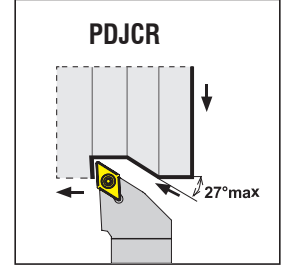
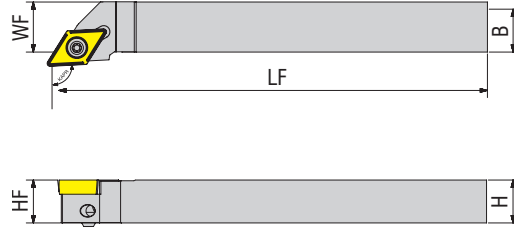
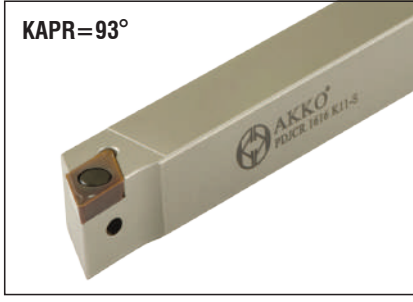

Takım Kodu Ordering Code Код для заказа	Stok Stock Наличие		Takım Ölçüleri (mm) Dimension (mm) Размеры (мм)				Kesici Uç Insert Пластина	Yedek Parçaları / Spare Parts / Запасные части						
	R	L	HF=H	B	LF	WF		Levyeye Lever Рычаг	Levyeye Vidası Lever Screw Винт рычага	Altılık Shim Опорная пластина	Altılık Yay Shim Spring Втулка рычага	Baskı Parçası Wedge Clamp Прижим	Baskı Vidası Clamp Screw Зажимной винт	Anahtar Allen Key Ключ
PDJCR/L 1010 K11-S	●	○	10	10	125	10	DC.T 11T3..	APL-14 APL-15	2802-M4x8	-	-	-	-	AAL-01-02
1212 K11-S	●	○	12	12	125	12								
1616 K11-S	●	○	16	16	125	16								

R: Sağ / Right / Правый L: Sol / Left / Левый
● Stokta / In Stock / В наличии ○ Stokta Yok / Non Stock Item / Нет в наличии
ISO Uçuna Uygundur. / Compatible with ISO Insert. / Под пластину ISO.

Sipariş Örneği/Ordering Example/Образец заказа
1 ad./pcs./шт. PDJCR 1010 K11-S



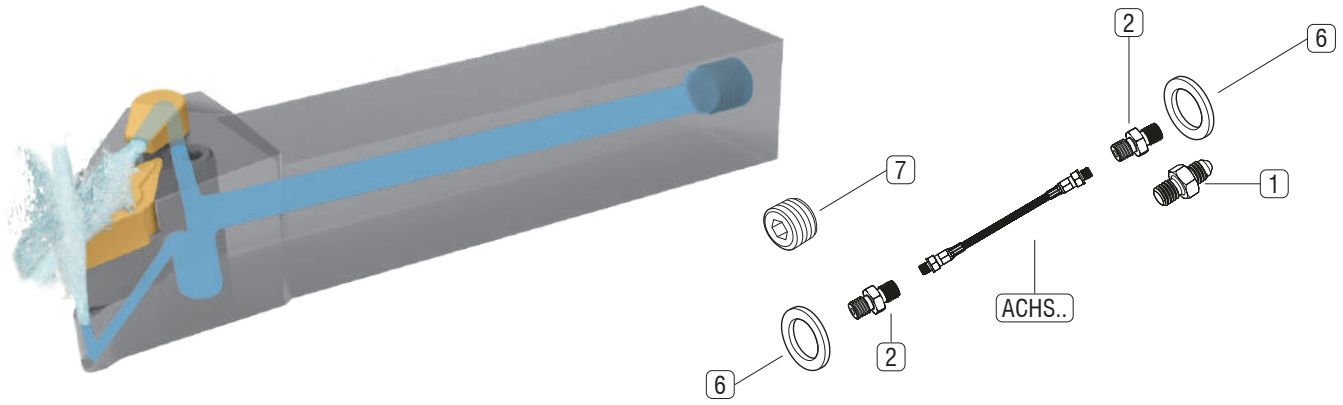

Not: İçten soğutmalı tüm torna katerlerinde kullanılacak 3 tip soğutma hortum setleri tasarlanmıştır. Takımların kullanılmasından önce, kullanılmayan bağlantıların set içindeki vida ile kapatılarak sızdırmazlığın sağlanmasına dikkat edilmelidir. Torna katerlerine yönelik soğutma hortum setleri, ACHS... 10 bar ile maksimum 150 bar basınç aralığında kullanılabilir.

Note: 3 types of cooling hose sets are designed that can be used in all internally cooled lathes. Before using the tools, care should be taken to ensure that the unused connections are closed with the screw in the set and that sealing is ensured. Cooling hose sets for lathe tools can be used in the pressure range of ACHS ... 10 bar to max 150 bar.

Примечание: Предлагается 3 типа комплектов трубок для подвода СОЖ. Они могут использоваться на всех токарных станках оснащенных системой подвода СОЖ. Перед началом работ необходимо закрыть неиспользуемые соединения винтом из набора и обеспечить герметичность системы подвода СОЖ. Комплекты охлаждающих трубок, для токарных инструментов, могут использоваться в диапазоне давлений ACHS от 10 бар до 150 бар.

Set İçindeki Parçalar Parts In The Set Запчасти в Наборе				Uzunluk / Length Code / Длина		
				Set Kodu: Set Code: Код Набора: ACHS-1-250	Set Kodu: Set Code: Код Набора: ACHS-2-250	Set Kodu: Set Code: Код Набора: ACHS-3-250
	Resim Picture Рисунок	Takım Kodu Set Code Код Набора	Ürün Açıklaması Product Description Описание товара			
1		AMP-01	M10 Bağlantı Elemanı M10 Fastener Застежка M10	1x	-	-
2		AMP-02	G 1/8" Çift Bağlantı Elemanı G 1/8" Double Fastener G 1/8" двойная застежка	2x	1x	-
3		AMP-03	G 1/8" Açılı Bağlantısı G 1/8" Angle Connection G 1/8" угловое соединение	-	1x	2x
4		AMP-04	M10" Açılı Bağlantısı M10" Angle Connection M10" угловое соединение	-	1x	1x
5		AMP-05	G1/4"-G1/8" Kılcalma Parçası G1 / 4"-G1/8" Capillary Piece G1 / 4"-G1/8" Капиллярная часть	-	1x	1x
6		AG-01	Bakır Conta Copper Gasket Медная прокладка	2x	3x	4x
7		2705-G1/8-5.5	G1/8" Sızdırmaz Civata G1/8" Sealing Bolt G1/8" Уплотнительный болт	1x	1x	1x
8		AH-1-250	Hortum Hose Трубка	1x	-	-
9		AH-2-250	Hortum Hose Трубка	-	1x	-
10		AH-3-250	Hortum Hose Трубка	-	-	1x



*konusulan
the spoken kalite...
quality...*

C-SİSTEM

C-SİSTEM DIŞ TORNA KATERLERİ
C-SYSTEM EXTERNAL TURNING TOOLHOLDERS
C-ТИП ДЕРЖАВКИ ДЛЯ НАРУЖНОГО ТОЧЕНИЯ



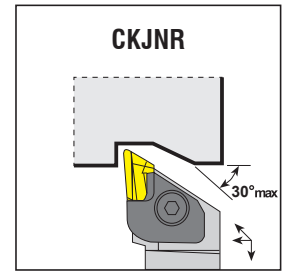
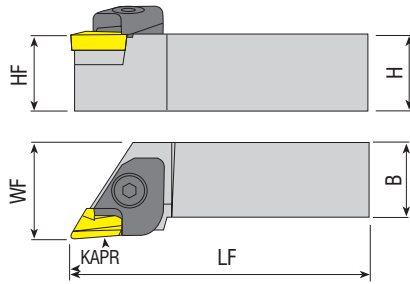

Takım Kodu
Ordering Code
Код для заказа

Stok Stock Наличие	Takım Ölçüleri (mm) Dimension (mm) Размеры (мм)					Kesici Uç Insert Пластина	Yedek Parçaları / Spare Parts / Запасные части								
	R	L	HF=H	B	LF		WF	Baskı Pabuçu Wedge Clamp Прижим	Pabuç Vidası Clamp Screw Зажимной винт	Altlık Shim Опорная пластина	Altlık Vidası Shim Screw Винт опорной пластины	Yay Spring Пружина	Pul Stamp Шайба	Anahtar Allen Key Ключ	
	●	●	20	20	125	27.5	KNUX 1604..								
CKJNR/L 2020 K16	●	●	25	25	150	31.5									
2525 M16	●	●	32	32	170	40									
3232 P16	●	●	40	40	250	50									
4040 S16	●	●													

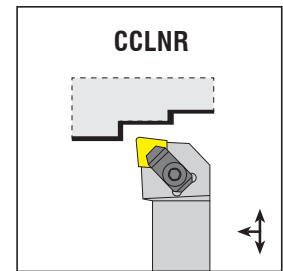
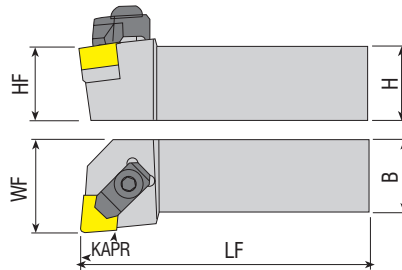
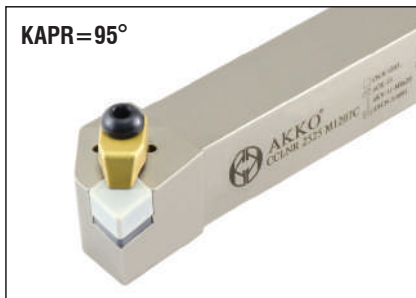

Takım Kodu
Ordering Code
Код для заказа

Stok Stock Наличие	Takım Ölçüleri (mm) Dimension (mm) Размеры (мм)					Kesici Uç Insert Пластина	Yedek Parçaları / Spare Parts / Запасные части						
	R	L	HF=H	B	LF		WF	Baskı Pabuçu Wedge Clamp Прижим	Pabuç Vidası Clamp Screw Зажимной винт	Altlık Shim Опорная пластина	Altlık Vidası Shim Screw Винт опорной пластины	Segman Ring Кольцо	Anahtar Allen Key Ключ
	●	●	25	25	150	32	CN.N 1207..						
CCLNR/L 2525 M1207C	●	●	32	32	170	40							
3232 P1207C	●	●	25	25	150	32	CN.N 1607..						
2525 M1607C	●	●											

R: Sağ / Right / Правый L: Sol / Left / Левый
● Stokta / In Stock / В наличии ○ Stokta Yok / Non Stock Item / Нет в наличии

Sipariş Örneği/Ordering Example/Образец заказа
1 ad./pcs./шт. CKJNR 2020 K16

C-SİSTEM SERAMİK UÇLAR İÇİN DİŞ TORNA KATERLERİ

C-SYSTEM EXTERNAL TURNING TOOLHOLDERS FOR CERAMIC INSERTS

С-ТИП ДЕРЖАВКИ ДЛЯ НАРУЖНОГО ТОЧЕНИЯ ПОД КЕРАМИЧЕСКИЕ ПЛАСТИНЫ

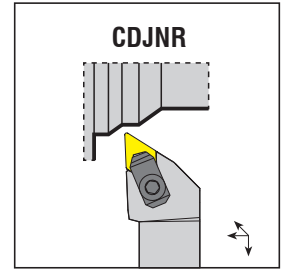
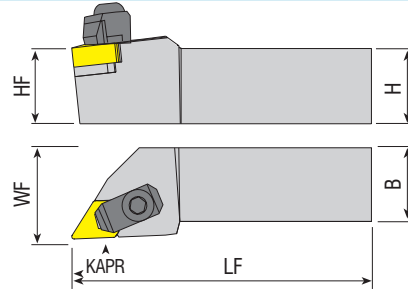

Takım Kodu Ordering Code Код для заказа	Stok Stock Наличие		Takım Ölçüleri (mm) Dimension (mm) Размеры (мм)				Kesici Uç Insert Пластина	Yedek Parçaları / Spare Parts / Запасные части					
	R	L	HF=H	B	LF	WF		Baskı Pabuçu Wedge Clamp Прижим	Pabuç Vidası Clamp Screw Зажимной винт	Aitlik Shim Опорная пластина	Aitlik Vidası Shim Screw Винт опорной пластины	Segman Ring Кольцо	Anahtar Allen Key Ключ
CDJNR/L 2525 M1107C	●	●	25	25	150	32	DN.N 1107..	ACK-22	AKV-11-M8x29	AADN-2-0001	AAV-04-M5x12	ACS-01	AAL-05-4
2525 M1507C	●	●	25	25	150	32	DN.N 1507..	ACK-13	AKV-11-M8x29	AADN-3-0001	AAV-02-M5x12	ACS-01	AAL-05-4
3232 P1507C	●	●	32	32	170	40							

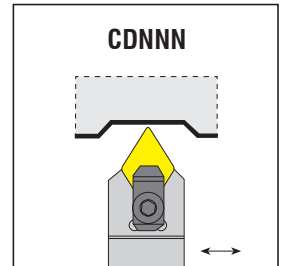
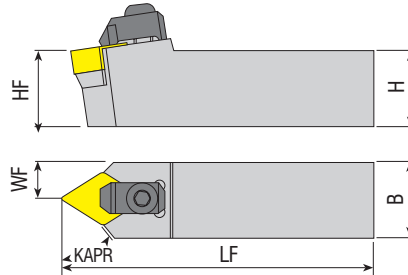

Takım Kodu Ordering Code Код для заказа	Stok Stock Наличие		Takım Ölçüleri (mm) Dimension (mm) Размеры (мм)				Kesici Uç Insert Пластина	Yedek Parçaları / Spare Parts / Запасные части					
	R	L	HF=H	B	LF	WF		Baskı Pabuçu Wedge Clamp Прижим	Pabuç Vidası Clamp Screw Зажимной винт	Aitlik Shim Опорная пластина	Aitlik Vidası Shim Screw Винт опорной пластины	Segman Ring Кольцо	Anahtar Allen Key Ключ
CDNNN 2525 M1107C	●		25	25	150	12.5	DN.N 1107..	ACK-22	AKV-11-M8x29	AADN-2-0001	AAV-04-M5x12	ACS-01	AAL-05-4

R: Sağ / Right / Правый L: Sol / Left / Левый

● Stokta / In Stock / В наличии ○ Stokta Yok / Non Stock Item / Нет в наличии

Sipariş Örneği/Ordering Example/Образец заказа

1 ad./pcs./шт. CDJNR 2525 M1107C

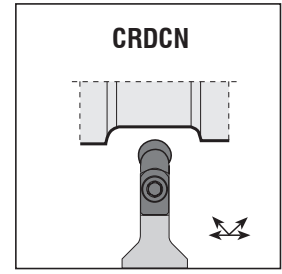
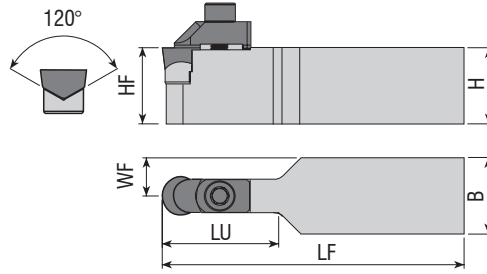

Takım Kodu
Ordering Code
Код для заказа

Stok Stock Наличие	Takım Ölçüleri (mm) Dimension (mm) Размеры (мм)					Kesici Uç Insert Пластина	Yedek Parçaları / Spare Parts / Запасные части					
	HF=H	B	LF	LU	WF		Baskı Pabuçu Wedge Clamp Прижим	Pabuç Vidası Clamp Screw Зажимной винт	Altık Shim Отпорная пластина	Altık Vidası Shim Screw Винт отпорной пластины	Anahtar Allen Key Ключ	
CRDCN 2525 M06CV	●	25	25	150	19	12.5	RCGX 0606..	ACK-27	2525-M3X14	AARC-3-0001	3007-M2.2x5	AAL-02-2.5
3225 P06CV	●	32	25	170	19	12.5						
4040 S06CV	●	40	40	250	19	20						
2525 M09CV	●	25	25	150	29	12.5	RCGX 0907..	ACK-28	2504-M5X16	AARC-3-0002	3008-M2.5x6	AAL-05-4
3225 P09CV	●	32	25	170	29	12.5						
4040 S09CV	●	40	40	250	29	20						
2525 M12CV	●	25	25	150	38	12.5	RCGX 1207..	ACK-29	2505-M6X20	AARC-3-0003	3008-M2.5x6	AAL-07-5
3225 P12CV	●	32	25	170	38	12.5						
4040 S12CV	●	40	40	250	38	20						

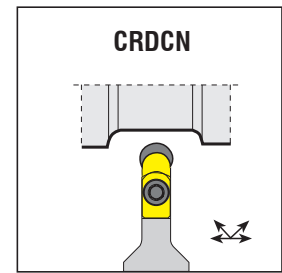
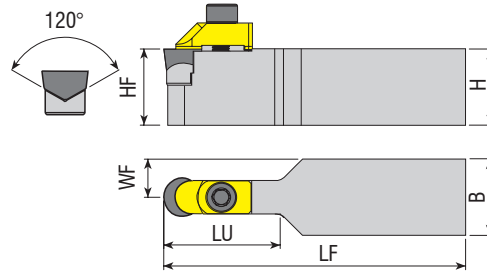

Takım Kodu
Ordering Code
Код для заказа

Stok Stock Наличие	Takım Ölçüleri (mm) Dimension (mm) Размеры (мм)					Kesici Uç Insert Пластина	Yedek Parçaları / Spare Parts / Запасные части					
	HF=H	B	LF	LU	WF		Baskı Pabuçu Wedge Clamp Прижим	Pabuç Vidası Clamp Screw Зажимной винт	Altık Shim Отпорная пластина	Altık Vidası Shim Screw Винт отпорной пластины	Anahtar Allen Key Ключ	
CRDCN 3232 P06CVK	●	32	32	170	19	16	RCGX 0606..	ACK-42	2525-M3x12	AARC-3-0005	2008-M2.5X12	AAL-02-2.5
4040 R06CVK	●	40	40	200	19	20						
3232 P09CVK	●	32	32	170	29	16	RCGX 0907..	ACK-43	2504-M5x14	AARC-3-0006	4015-M3.5x14	AAL-05-4
4040 R09CVK	●	40	40	200	29	20						
3232 P12CVK	●	32	32	170	38	16	RCGX 1207..	ACK-44	2505-M6x16	AARC-3-0007	1620-M5x18	AAL-07-5
4040 R12CVK	●	40	40	200	38	20						

R: Sağ / Right / Правый L: Sol / Left / Левый

● Stokta / In Stock / В наличии ○ Stokta Yok / Non Stock Item / Нет в наличии

Sipariş Örneği/Ordering Example/Образец заказа
1 ad./pcs./шт. CRDCN 2525 M06CV

C-SİSTEM SERAMİK UÇLAR İÇİN DIŞ TORNA KATERLERİ

C-SYSTEM EXTERNAL TURNING TOOLHOLDERS FOR CERAMIC INSERTS

C-ТИП ДЕРЖАВКИ ДЛЯ НАРУЖНОГО ТОЧЕНИЯ ПОД КЕРАМИЧЕСКИЕ ПЛАСТИНЫ

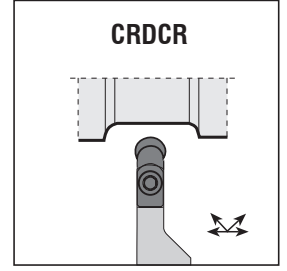
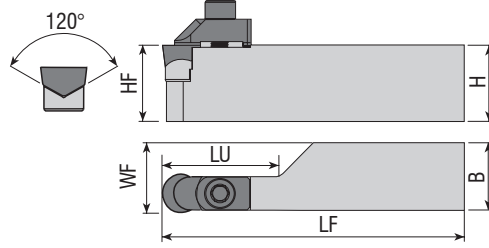

Takım Kodu
Ordering Code
Код для заказа

Stok
Stock
Наличие

R L

Takım Ölçüleri (mm)
Dimension (mm)
Размеры (мм)

HF=H B LF LU WF

Kesici Uç
Insert
Пластина



Baskı Pabucu
Wedge Clamp
Прижим



Pabuç Vidası
Clamp Screw
Зажимной винт



Altlık
Shim
Опорная пластина



Altlık Vidası
Shim Screw
Винт опорной пластины



Anahtar
Allen Key
Ключ



CRDCR/L 3225 P06CV
3225 P09CV
3225 P12CV

● ●

32 25 170 19.4 25.6
32 25 170 29 25.8
32 25 170 38.5 25.9

RCGX 0606..
RCGX 0907..
RCGX 1207..

ACK-27
ACK-28
ACK-29

2525-M3X14
2504-M5X16
2505-M6X20

AARC-3-0001
AARC-3-0002
AARC-3-0003

3007-M2.2X4.6
3008-M2.5X6
3008-M2.5X6

AAL-02-2.5
AAL-05-4
AAL-07-5



KAPR=45°

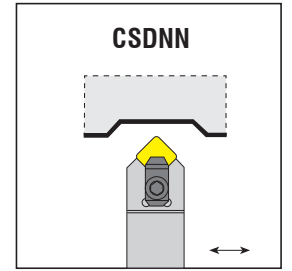
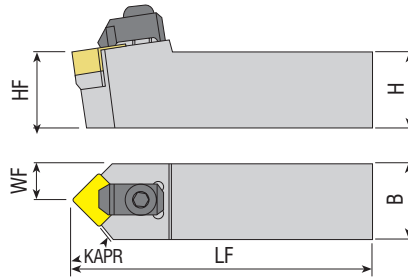

Takım Kodu
Ordering Code
Код для заказа

Stok
Stock
Наличие

HF=H B LF WF

Takım Ölçüleri (mm)
Dimension (mm)
Размеры (мм)

HF=H B LF WF

Kesici Uç
Insert
Пластина



Baskı Pabucu
Wedge Clamp
Прижим



Pabuç Vidası
Clamp Screw
Зажимной винт



Altlık
Shim
Опорная пластина



Altlık Vidası
Shim Screw
Винт опорной пластины



Segman
Ring
Кольцо



Anahtar
Allen Key
Ключ



CSDNN 2525 M1207C
3232 P1207C

● ●

25 25 150 12.5
32 32 170 16

SN.N 1207..

ACK-13

AKV-11-M8x29

AASN-3-0004

AAV-02-M5x12

ACS-01

AAL-05-4

R: Sağ / Right / Правый L: Sol / Left / Левый

● Stokta / In Stock / В наличии ○ Stokta Yok / Non Stock Item / Нет в наличии

Sipariş Örneği/Ordering Example/Образец заказа

1 ad./pcs./шт. CRDCR 3225 P06CV

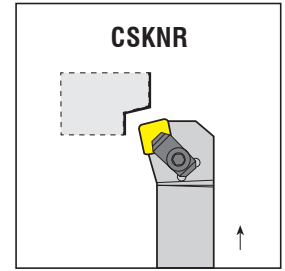
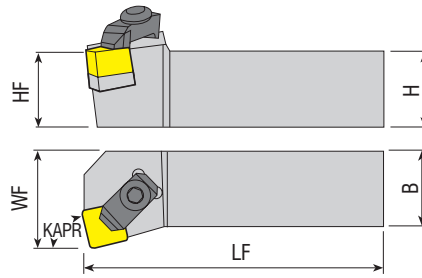
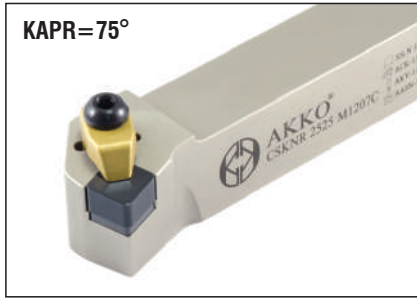

Takım Kodu Ordering Code Код для заказа	Stok Stock Наличие		Takım Ölçüleri (mm) Dimension (mm) Размеры (мм)				Kesici Uç Insert Пластина	Yedek Parçaları / Spare Parts / Запасные части					
	R	L	HF=H	B	LF	WF		Baskı Pabucu Wedge Clamp Прижим	Pabuç Vidası Clamp Screw Зажимной винт	Altlık Shim Опорная пластина	Altlık Vidası Shim Screw Винт опорной пластины	Segman Ring Кольцо	Anahtar Allen Key Ключ
CSKNR/L 2525 M1207C 3232 P1207C	●	●	25	25	150	32	SN.N 1207..	ACK-13	AKV-11-M8x29	AASN-3-0004	AAV-02-M5x12	ACS-01	AAL-05-4
	●	●	32	32	170	40							

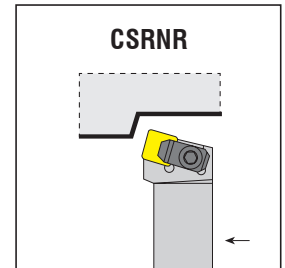
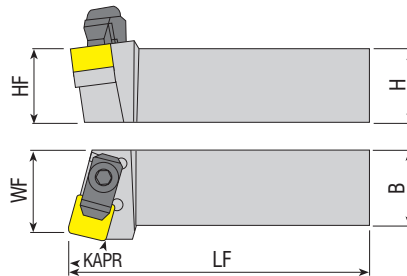
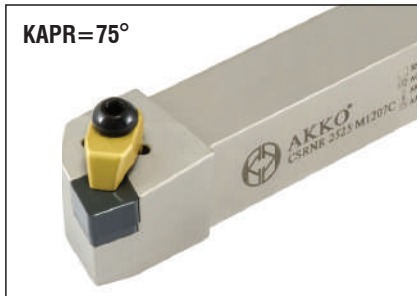

Takım Kodu Ordering Code Код для заказа	Stok Stock Наличие		Takım Ölçüleri (mm) Dimension (mm) Размеры (мм)				Kesici Uç Insert Пластина	Yedek Parçaları / Spare Parts / Запасные части					
	R	L	HF=H	B	LF	WF		Baskı Pabucu Wedge Clamp Прижим	Pabuç Vidası Clamp Screw Зажимной винт	Altlık Shim Опорная пластина	Altlık Vidası Shim Screw Винт опорной пластины	Segman Ring Кольцо	Anahtar Allen Key Ключ
CSRNR/L 2525 M1207C 3232 P1207C	●	●	25	25	150	32	SN.N 1207..	ACK-13	AKV-11-M8x29	AASN-3-0004	AAV-02-M5x12	ACS-01	AAL-05-4
	●	●	32	32	170	40							

R: Sağ / Right / Правый L: Sol / Left / Левый

● Stokta / In Stock / В наличии ○ Stokta Yok / Non Stock Item / Нет в наличии

Sipariş Örneği/Ordering Example/Образец заказа

1 ad./pcs./шт. CSKNR 2525 M1207C

C-SİSTEM SERAMİK UÇLAR İÇİN DİŞ TORNA KATERLERİ

C-SYSTEM EXTERNAL TURNING TOOLHOLDERS FOR CERAMIC INSERTS

C-ТИП ДЕРЖАВКИ ДЛЯ НАРУЖНОГО ТОЧЕНИЯ ПОД КЕРАМИЧЕСКИЕ ПЛАСТИНЫ

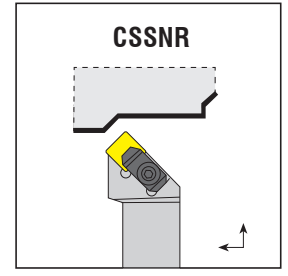
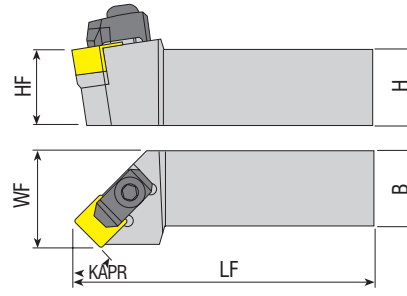

Takım Kodu Ordering Code Код для заказа	Stok Stock Наличие		Takım Ölçüleri (mm) Dimension (mm) Размеры (мм)				Kesici Uç Insert Пластина	Yedek Parçaları / Spare Parts / Запасные части					
	R	L	HF=H	B	LF	WF		Baskı Pabuçu Wedge Clamp Прижим	Pabuç Vidası Clamp Screw Зажимной винт	Altlık Shim Опорная пластина	Altlık Vidası Shim Screw Винт опорной пластины	Segman Ring Кольцо	Anahtar Allen Key Ключ
	●	○											
CSSNR/L 2525 M1207C	●	●	25	25	150	32	SN.N 1207..	ACK-13	AKV-11-M8x29	AASN-3-0004	AAV-02-M5x12	ACS-01	AAL-05-4
3232 P1207C	●	●	32	32	170	40							

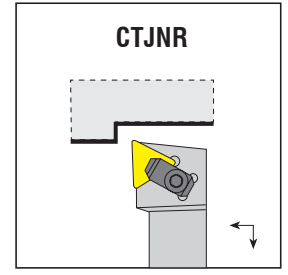
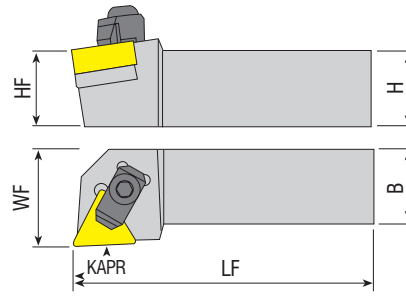

Takım Kodu Ordering Code Код для заказа	Stok Stock Наличие		Takım Ölçüleri (mm) Dimension (mm) Размеры (мм)				Kesici Uç Insert Пластина	Yedek Parçaları / Spare Parts / Запасные части					
	R	L	HF=H	B	LF	WF		Baskı Pabuçu Wedge Clamp Прижим	Pabuç Vidası Clamp Screw Зажимной винт	Altlık Shim Опорная пластина	Altlık Vidası Shim Screw Винт опорной пластины	Segman Ring Кольцо	Anahtar Allen Key Ключ
	●	○											
CTJNR/L 2525 M1607C	●	●	25	25	150	32	TN.N 1607..	ACK-14	AKV-11-M8x29	AATN-2-0002	AAV-03-M5x12	ACS-01	AAL-05-4
3232 P1607C	○	○	32	32	170	40							

R: Sağ / Right / Правый L: Sol / Left / Левый

● Stokta / In Stock / В наличии ○ Stokta Yok / Non Stock Item / Нет в наличии

Sipariş Örneği/Ordering Example/Образец заказа

1 ad./pcs./шт. CSSNR 2525 M1207C

S-SİSTEM

S-SİSTEM DIŞ TORNA KATERLERİ
S-SYSTEM EXTERNAL TURNING TOOLHOLDERS
S-ТИП ДЕРЖАВКИ ДЛЯ НАРУЖНОГО ТОЧЕНИЯ

*konusulan
the spoken kalite...
quality...*



S-SİSTEM DIŞ TORNA KATERLERİ
S-SYSTEM EXTERNAL TURNING TOOLHOLDERS
S-ТИП ДЕРЖАВКИ ДЛЯ СТАНКОВ АВТОМАТОВ ШВЕЙЦАРСКОГО ТИПА

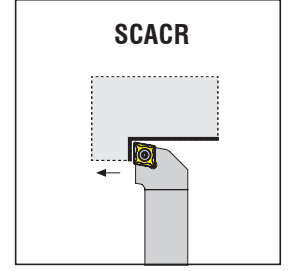
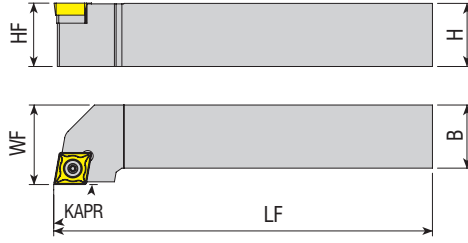

Takım Kodu Ordering Code Код для заказа	Stok Stock Наличие		Takım Ölçüleri (mm) Dimension (mm) Размеры (мм)				Kesici Uç Insert Пластина	Yedek Parçaları / Spare Parts / Запасные части			
	R	L	HF=H	B	LF	WF		Sıkma Vidası Screw Зажимной винт	Altık Shim Опорная пластина	Altık Vidası Shim Screw Винт опорной пластины	Tork Anahtar Torx Key Торх Ключ
SCACR/L 0808 E06	●	●	08	08	70	10	CCM. 0602..	4008-M2.5x6	-	-	82-T08
1010 E06	●	●	10	10	70	12					
1212 F09	●	●	12	12	80	16					
1616 H09	●	●	16	16	100	20	CC.T 09T3..	4015-M3.5x14	AACN-2-0001	AAV-06-M3.5x11	80-T15
2020 K09	●	●	20	20	125	25					
2020 K12	●	●	20	20	125	25	CC.T 1204..	1020-M4.5x16	AACN-2-0003	AAV-07-M4.5x13	80-T20
2525 M12	●	●	25	25	150	32					

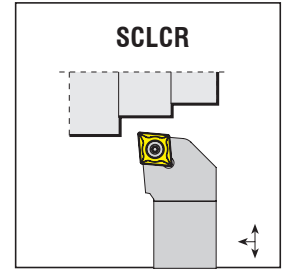
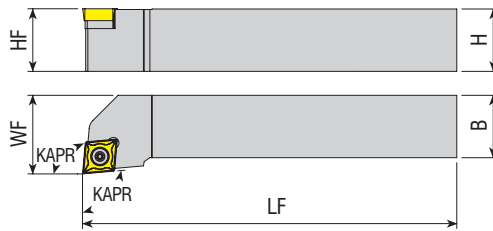
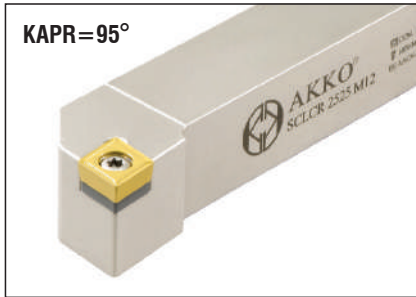

Takım Kodu Ordering Code Код для заказа	Stok Stock Наличие		Takım Ölçüleri (mm) Dimension (mm) Размеры (мм)				Kesici Uç Insert Пластина	Yedek Parçaları / Spare Parts / Запасные части			
	R	L	HF=H	B	LF	WF		Sıkma Vidası Screw Зажимной винт	Altık Shim Опорная пластина	Altık Vidası Shim Screw Винт опорной пластины	Tork Anahtar Torx Key Торх Ключ
SCLCR/L 0808 E06	●	●	08	08	70	10	CCM. 0602..	4008-M2.5x6	-	-	82-T08
1010 E06	●	○	10	10	70	12					
1212 F06	●	●	12	12	80	16					
1010 E09	●	●	10	10	70	12	CC.T 09T3..	4015-M3.5x9 4015-M3.5x11	-	-	80-T15
1212 F09	●	●	12	12	80	16					
1616 H09	●	●	16	16	100	20	CC.T 1204..	4015-M3.5x14	AACN-2-0001	AAV-06-M3.5x11	80-T15
2020 K09	●	●	20	20	125	25					
2525 M09	●	●	25	25	150	32	CC.T 1204..	1020-M5x11	-	-	80-T20
1616 H12	●	○	16	16	100	20					
2020 K12	●	●	20	20	125	25	CC.T 1204..	1020-M4.5x16	AACN-2-0003	AAV-07-M4.5x13	80-T20
2525 M12	●	●	25	25	150	32					

R: Sağ / Right / Правый L: Sol / Left / Левый
● Stokta / In Stock / В наличии ○ Stokta Yok / Non Stock Item / Нет в наличии

Sipariş Örneği/Ordering Example/Образец заказа
1 ad./pcs./шт. SCACR 0808 E06

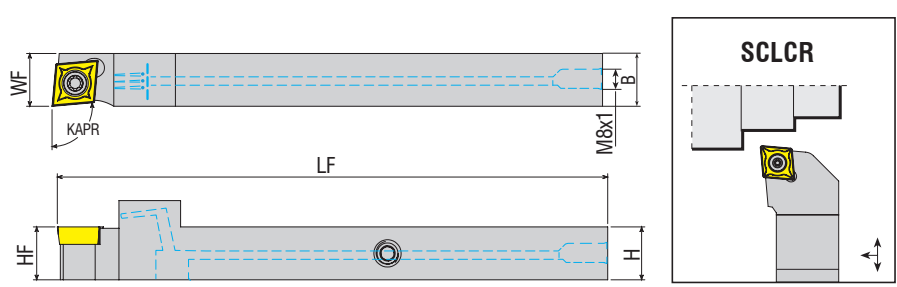
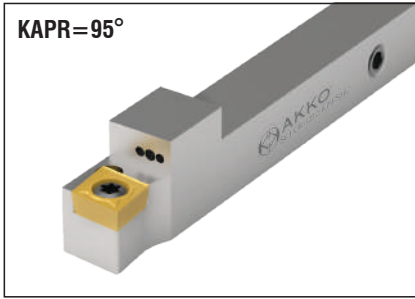

Takım Kodu Ordering Code Код для заказа	Stok Stock Наличие						Kesici Uç Insert Пластина	Yedek Parçaları / Spare Parts / Запасные части					
	Takım Ölçüleri (mm) Dimension (mm) Размеры (мм)							Sıkma Vidası Screw Зажимной винт	Altılık Shim Опорная пластина	Altılık Vidası Shim Screw Винт опорной пластины	Sızdırmaz Vida Threaded Pin Резьбовой Винт	Anahtar Allen Key Ключ	Tork Anahtar Torx Key Торх Ключ
	R	L	HF=H	B	LF	WF							
SCLCR/L 1212 K09-SHC	●	○	12	12	125	12	CC.T 09T3..	4015-M3.5x11	-	-	2703-M6X4	AAL-03-3	80-T15
1616 K09-SHC	●	○	16	16	125	16					2704-M8X1X5		

ISO Ucuna Uygundur. / Compatible with ISO Insert. / Под пластину ISO.

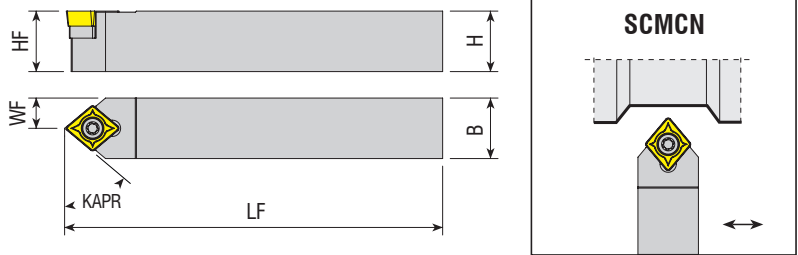

Takım Kodu Ordering Code Код для заказа	Stok Stock Наличие					Kesici Uç Insert Пластина	Yedek Parçaları / Spare Parts / Запасные части				
	Takım Ölçüleri (mm) Dimension (mm) Размеры (мм)						Sıkma Vidası Screw Зажимной винт	Altılık Shim Опорная пластина	Altılık Vidası Shim Screw Винт опорной пластины	Tork Anahtar Torx Key Торх Ключ	
	HF=H	B	LF	WF							
SCMCN 0808 E06	●	○	08	08	70	04	CCM. 0602..	4008-M2.5x6	-	-	82-T08
1010 E06	●	○	10	10	70	05					
1212 F06	●	○	12	12	80	06					
1212 F09	●	○	12	12	80	06	CC.T 09T3..	4015-M3.5x11	-	-	80-T15
1616 H09	●	○	16	16	100	08					
2020 K12	●	○	20	20	125	10	CC.T 1204..	1020-M4.5x16	AACN-2-0003	AAV-07-M4.5x13	80-T20
2525 M12	●	○	25	25	150	12.5					

R: Sağ / Right / Правый L: Sol / Left / Левый
● Stokta / In Stock / В наличии ○ Stokta Yok / Non Stock Item / Нет в наличии

Sipariş Örneği/Ordering Example/Образец заказа
1 ad./pcs./шт. SCLCR/L 1212 K09-SHC

S-SİSTEM DIŞ TORNA KATERLERİ
S-SYSTEM EXTERNAL TURNING TOOLHOLDERS
S-ТИП ДЕРЖАВКИ ДЛЯ СТАНКОВ АВТОМАТОВ ШВЕЙЦАРСКОГО ТИПА

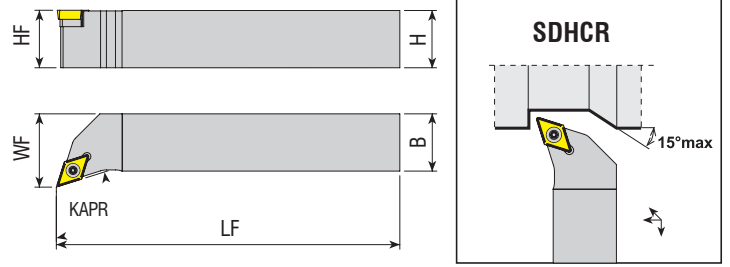
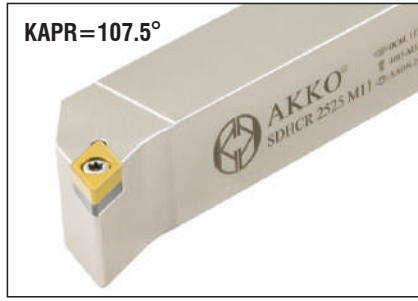

Takım Kodu Ordering Code Код для заказа	Stok Stock Наличие		Takım Ölçüleri (mm) Dimension (mm) Размеры (мм)				Kesici Uç Insert Пластина	Yedek Parçaları / Spare Parts / Запасные части				
	R	L	HF=H	B	LF	WF		Sıkma Vidası Screw Зажимной винт	Altlık Shim Опорная пластина	Altlık Vidası Shim Screw Винт опорной пластины	Tork Anahtar Torx Key Торх Ключ	
SDHCR/L 0808 E07	●	●	08	08	70	11	DC.T 0702..					
1010 E07	●	●	10	10	70	12						
1212 F07	●	●	12	12	80	16						
1616 H07	●	●	16	16	100	20						
1616 H11	●	●	16	16	100	20						
2020 K11	●	●	20	20	125	25	DC.T 11T3..					
2525 M11	●	●	25	25	150	32						
3232 P11	●	●	32	32	170	40						

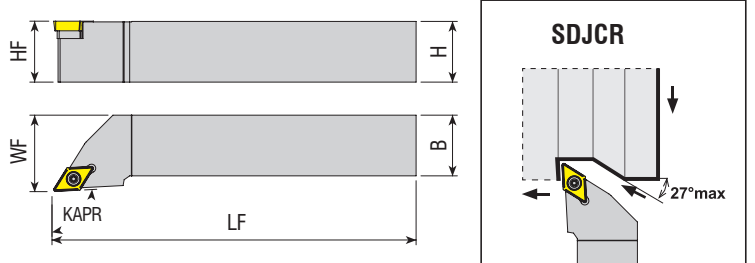
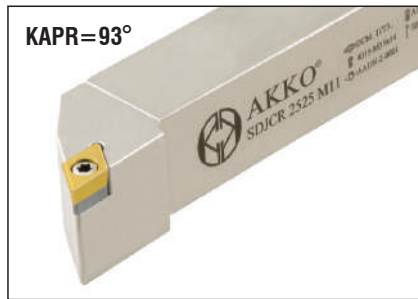

Takım Kodu Ordering Code Код для заказа	Stok Stock Наличие		Takım Ölçüleri (mm) Dimension (mm) Размеры (мм)				Kesici Uç Insert Пластина	Yedek Parçaları / Spare Parts / Запасные части				
			HF=H	B	LF	WF		Sıkma Vidası Screw Зажимной винт	Altlık Shim Опорная пластина	Altlık Vidası Shim Screw Винт опорной пластины	Tork Anahtar Torx Key Торх Ключ	
SDJCR/L 0808 E07	●	●	08	08	70	10	DC.T 0702..					
1010 E07	●	●	10	10	70	12						
1212 F07	●	●	12	12	80	16						
1616 H07	●	●	16	16	100	20						
1212 F11	●	●	12	12	80	16						
1616 H11	●	●	16	16	100	20	DC.T 11T3..					
2020 K11	●	●	20	20	125	25						
2525 M11	●	●	25	25	150	32						
3232 P11	●	●	32	32	170	40						

R: Sağ / Right / Правый L: Sol / Left / Левый
 ● Stokta / In Stock / В наличии ○ Stokta Yok / Non Stock Item / Нет в наличии

Sipariş Örneği/Ordering Example/Образец заказа
 1 ad./pcs./шт. SDHCR 0808 E07



KAPR=93°

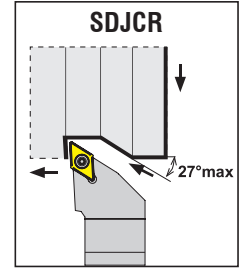
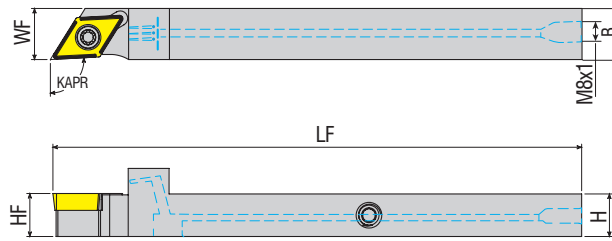

Takım Kodu Ordering Code Код для заказа	Stok Stock Наличие		Takım Ölçüleri (mm) Dimension (mm) Размеры (мм)				Kesici Uç Insert Пластина	Sıkma Vidası Screw Зажимной винт	Altılık Shim Опорная пластина	Altılık Vidası Shim Screw Винт опорной пластины	Sızdırmaz Vida Threaded Pin Резьбовой Винт	Anahtar Allen Key Ключ	Tork Anahtar Torx Key Торх Ключ
	R	L	HF=H	B	LF	WF							
	Yedek Parçaları / Spare Parts / Запасные части												
SDJCR/L 0810 G07-SHC	●	○	8	10	90	10	DC.T 0702..	4008-M2.5x6					82-T08
1010 K07-SHC	●	○	10	10	125	10							
1012 K11-SHC	●	○	10	12	125	12	DC.T 11T3..	4015-M3.5x14			2703-M6X4	AAL-03-3	80-T15
1212 K11-SHC	●	○	12	12	125	12					2704-M8X1X5	AAL-05-4	
1616 K11-SHC	●	○	16	16	125	16							

ISO Ucuna Uygundur. / Compatible with ISO Insert. / Под пластину ISO.

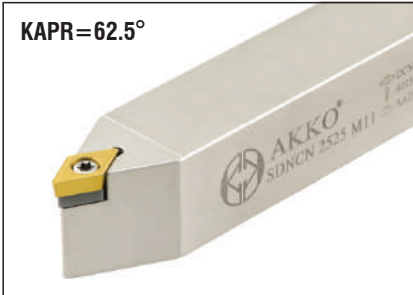

KAPR=62.5°

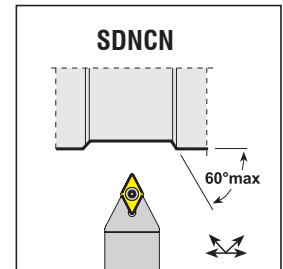
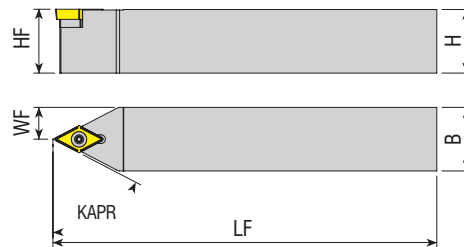

Takım Kodu Ordering Code Код для заказа	Stok Stock Наличие		Takım Ölçüleri (mm) Dimension (mm) Размеры (мм)				Kesici Uç Insert Пластина	Sıkma Vidası Screw Зажимной винт	Altılık Shim Опорная пластина	Altılık Vidası Shim Screw Винт опорной пластины	Tork Anahtar Torx Key Торх Ключ
	R	L	HF=H	B	LF	WF					
	Yedek Parçaları / Spare Parts / Запасные части										
SDNCN 0808 E07	●		08	08	70	4	DC.T 0702..	4008-M2.5x6			82-T08
1010 E07	●		10	10	70	5					
1212 F07	●		12	12	80	6					
1616 H07	●		16	16	100	8	DC.T 11T3..	4015-M3.5x14	AADN-2-0001	AAV-06-M3.5x11	80-T15
1616 H11	●		16	16	100	8					
2020 K11	●		20	20	125	10					
2525 M11	●		25	25	150	12.5					
3232 P11	●		32	32	170	16					

R: Sağ / Right / Правый L: Sol / Left / Левый

● Stokta / In Stock / В наличии ○ Stokta Yok / Non Stock Item / Нет в наличии

Sipariş Örneği/Ordering Example/Образец заказа

1 ad./pcs./шт. SDJCR/L 0810 G07-SHC

S-SİSTEM DIŞ TORNA KATERLERİ
S-SYSTEM EXTERNAL TURNING TOOLHOLDERS
S-ТИП ДЕРЖАВКИ ДЛЯ СТАНКОВ АВТОМАТОВ ШВЕЙЦАРСКОГО ТИПА

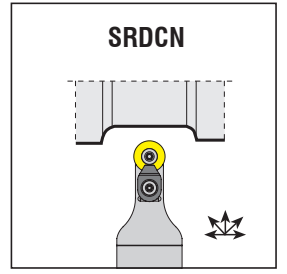
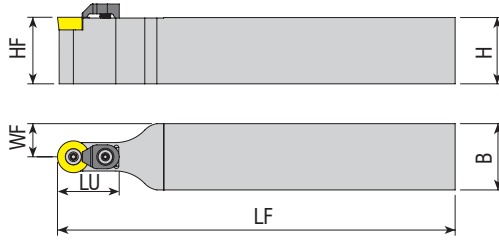

Takım Kodu
Ordering Code
Код для заказа

Takım Kodu Ordering Code Код для заказа	Stok Stock Наличие	Takım Ölçüleri (mm) Dimension (mm) Размеры (мм)					Kesici Uç Insert Пластина	Yedek Parçaları / Spare Parts / Запасные части							
		HF=H	B	LF	LU	WF		Sıkma Vidası Screw Зажимной винт	Altlık Shim Сторонняя пластина	Altlık Vidası Shim Screw Винт сторонней пластины	Baskı Parçası Wedge Clamp Прижим	Baskı Vidası Clamp Screw Зажимной винт	Tork Anahtar Torx Key Торх Ключ		
SRDCN 1616 H06	●	16	16	100	15	8									
2020 K06	●	20	20	125	17	10	RC.T 0602..	3008-M2.5x6	-	-	-	-			
2525 M06	●	25	25	150	17	12.5									
1616 H08C	●	16	16	100	15	8									82-T08
2020 K08C	●	20	20	125	20	10	RC.T 0803..	3008-M3x8	-	-					
2525 M08C	●	25	25	150	20	12.5									
1616 H10C	●	16	16	100	20	8					ACK-15	4015-M3.5x11			
2020 K10C	●	20	20	125	20	10	RC.T 10T3..	4015-M3.5x11	-	-					
2525 M10C	●	25	25	150	20	12.5									
3232 P10C	●	32	32	170	20	16									
2020 K12C	●	20	20	125	22	10									80-T15
2525 M12C	●	25	25	150	22	12.5	RC.T 1204..	4015-M3.5x11	-	-					
3232 P12C	●	32	32	170	22	16									
2525 M16C	●	25	25	150	32	12.5	RC.T 1605..	1020-M5x11	-	-	ACK-05	4015-M4x11			
3232 P16C	●	32	32	170	35	16									
2525 M20C	●	25	25	150	32	12.5	RC.T 2006..	1420-M6x16	-	-					80-T20
3232 P20C	●	32	32	170	40	16									
3232 P25C	●	32	32	170	40	16	RC.T 2507..	1520-M6x16	-	-	ACK-09	AAV-05-M6x15			
3232 P32C	●	32	32	170	45	16	RC.T 3209..	1904-M8x1x20							AAL-05-4

R: Sağ / Right / Правый L: Sol / Left / Левый
 ● Stokta / In Stock / В наличии ○ Stokta Yok / Non Stock Item / Нет в наличии

Sipariş Örneği/Ordering Example/Образец заказа
 1 ad./pcs./шт. SRDCN 1616 H06



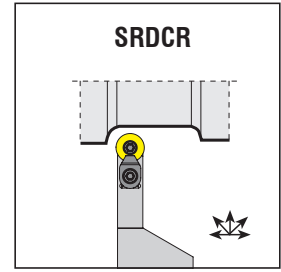
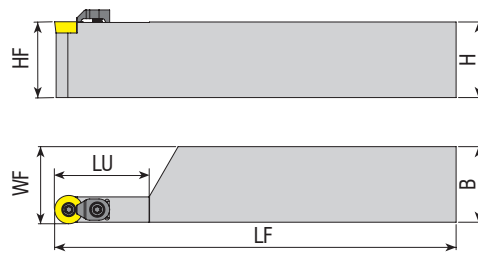

Takım Kodu
Ordering Code
Код для заказа

Takım Kodu Ordering Code Код для заказа	Stok Stock Наличие		Takım Ölçüleri (mm) Dimension (mm) Размеры (мм)				Kesici Uç Insert Пластина	Yedek Parçaları / Spare Parts / Запасные части						
	R	L	HF=H	B	LF	LU		WF	Sıkma Vidası Screw Зажимной винт	Altılık Shim Отпорная пластина	Altılık Vidası Shim Screw Винт отпорной пластины	Baskı Parçası Wedge Clamp Прижим	Baskı Vidası Clamp Screw Зажимной винт	Tork Anahtar Torx Key Торх Ключ
SRDCR/L 3232 T06	●	●	32	32	300	20	32.35	RC.T 0602..	3008-M2.5x6	-	-	-	-	82-T08
3232 P12C	●	●	32	32	170	40	32.65	RC.T 1204..	4015-M3.5x11	-	-	ACK-05	4015-M4x11	80-T15

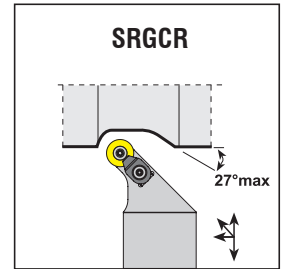
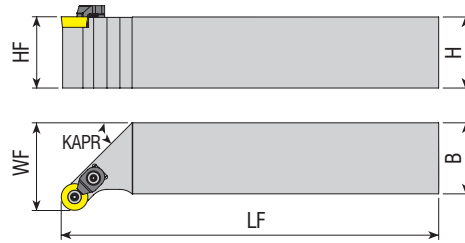

Takım Kodu
Ordering Code
Код для заказа

Takım Kodu Ordering Code Код для заказа	Stok Stock Наличие		Takım Ölçüleri (mm) Dimension (mm) Размеры (мм)				Kesici Uç Insert Пластина	Yedek Parçaları / Spare Parts / Запасные части					
	R	L	HF=H	B	LF	WF		Sıkma Vidası Screw Зажимной винт	Altılık Shim Отпорная пластина	Altılık Vidası Shim Screw Винт отпорной пластины	Baskı Parçası Wedge Clamp Прижим	Baskı Vidası Clamp Screw Зажимной винт	Tork Anahtar Torx Key Торх Ключ
SRGCR/L 1616 H06	●	●	16	16	100	20	RC.T 0602..	3008-M2.5x6	-	-	-	-	82-T08
2020 K06	●	●	20	20	125	25							
1616 H08C	●	●	16	16	100	20	RC.T 0803..	3008-M3x8	-	-	ACK-15	4015-M3.5x11	80-T15
2020 K08C	●	●	20	20	125	25							
2525 M08C	●	●	25	25	150	32	RC.T 10T3..	4015-M3.5x11	-	-	ACK-05	4015-M4x11	80-T15
1616 H10C	●	●	16	16	100	20							
2020 K10C	●	●	20	20	125	25							
2525 M10C	●	●	25	25	150	32							
3232 P10C	●	●	32	32	170	40	RC.T 1204..	4015-M3.5x11	-	-	ACK-05	4015-M4x11	80-T15
2020 K12C	●	●	20	20	125	25							
2525 M12C	●	●	25	25	150	32							
3232 P12C	●	●	32	32	170	40							

R: Sağ / Right / Правый L: Sol / Left / Левый

● Stokta / In Stock / В наличии ○ Stokta Yok / Non Stock Item / Нет в наличии

Sipariş Örneği/Ordering Example/Образец заказа

1 ad./pcs./шт. SRDCR 3232 T06

S-SİSTEM DIŞ TORNA KATERLERİ
S-SYSTEM EXTERNAL TURNING TOOLHOLDERS
S-ТИП ДЕРЖАВКИ ДЛЯ СТАНКОВ АВТОМАТОВ ШВЕЙЦАРСКОГО ТИПА

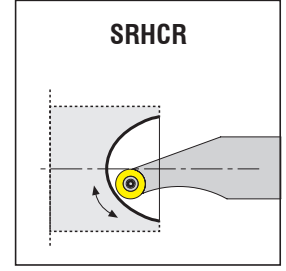
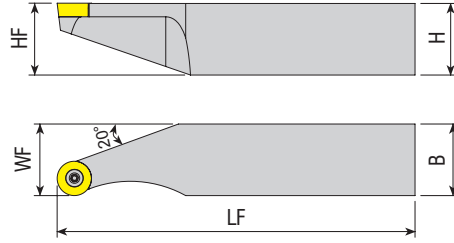

Takım Kodu Ordering Code Код для заказа	Stok Stock Наличие		Takım Ölçüleri (mm) Dimension (mm) Размеры (мм)				Kesici Uç Insert Пластина	Yedek Parçaları / Spare Parts / Запасные части				
	R	L	HF=H	B	LF	WF		MIN R	Sıkma Vidası Screw Зажимной винт	Altlık Shim Опорная пластина	Altlık Vidası Shim Screw Винт опорной пластины	Tork Anahtar Torx Key Торх Ключ
SRHCR/L 2525 K06	●	○	25	25	125	25	32.5	RC.T 0602..	3008-M2.5x6	-	-	82-T08
2525 K08	●	●	25	25	125	25	32.5	RC.T 0803..	3008-M3x8	-	-	
2525 K10	●	●	25	25	125	25	36	RC.T 10T3..	4015-M3.5x11	-	-	80-T15
2525 K12	●	●	25	25	125	25	40	RC.T 1204..				
2525 K16	●	●	25	25	125	25	47.5	RC.T 1606..	1020-M5x11	-	-	80-T20

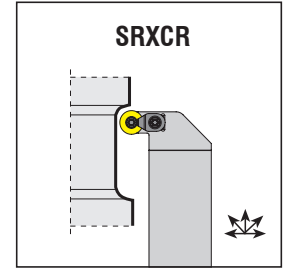

Takım Kodu Ordering Code Код для заказа	Stok Stock Наличие		Takım Ölçüleri (mm) Dimension (mm) Размеры (мм)				Kesici Uç Insert Пластина	Sıkma Vidası Screw Зажимной винт	Altlık Shim Опорная пластина	Altlık Vidası Shim Screw Винт опорной пластины	Baskı Parçası Wedge Clamp Прижим	Baskı Vidası Clamp Screw Зажимной винт	Tork Anahtar Torx Key Торх Ключ
	R	L	HF=H	B	LF	WF							
SRXCR/L 3232 X08C	●	●	32	32	220	47	RC.T 0803..	3008-M3x8			ACK-15	4015-M3.5x11	82-T08
3232 X10C	●	●	32	32	220	47	RC.T 10T3..	4015-M3.5x11	-	-			
3232 X12C	●	●	32	32	220	47	RC.T 1204..			ACK-05	4015-M4x11	80-T15	

R: Sağ / Right / Правый L: Sol / Left / Левый
● Stokta / In Stock / В наличии ○ Stokta Yok / Non Stock Item / Нет в наличии

Sipariş Örneği/Ordering Example/Образец заказа
1 ad./pcs./шт. SRHCR 2525 K06

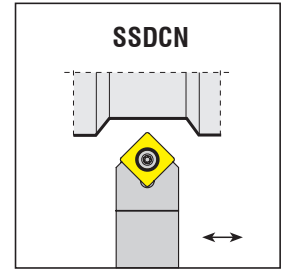
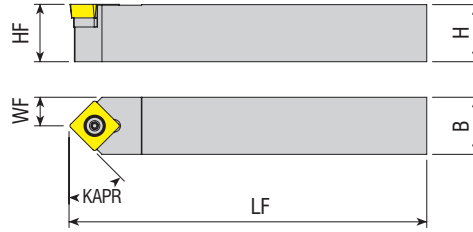
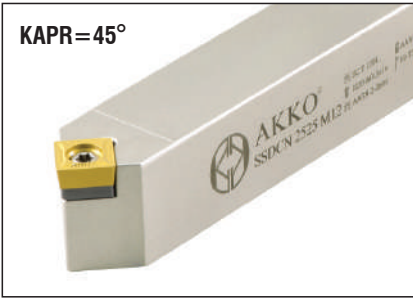

Takım Kodu Ordering Code Код для заказа	Stok Stock Наличие	Takım Ölçüleri (mm) Dimension (mm) Размеры (мм)				Kesici Uç Insert Пластина	Yedek Parçaları / Spare Parts / Запасные части			
		HF=H	B	LF	WF		Sıkma Vidası Screw Зажимной винт	Altlık Shim Опорная пластина	Altlık Vidası Shim Screw Винт опорной пластины	Tork Anahtar Torx Key Торх Ключ
SSDCN 1212 F09	●	12	12	80	6	SC.T 09T3..	4015-M3.5x11	-	-	80-T15
1616 H09	●	16	16	100	8		4015-M3.5x14	AASN-2-0001	AAV-06-M3.5x11	
2020 K09	●	20	20	125	10		4020-M4.5x12		AAV-10-M4.5x8	
1616 H12	●	16	16	100	8	SC.T 1204..	1020-M4.5x16	AASN-2-0004	AAV-07-M4.5x13	80-T20
2020 K12	●	20	20	125	10					
2525 M12	●	25	25	150	12.5					

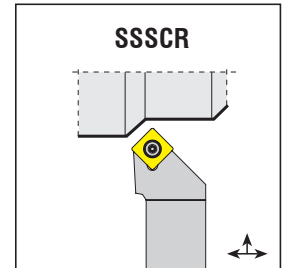
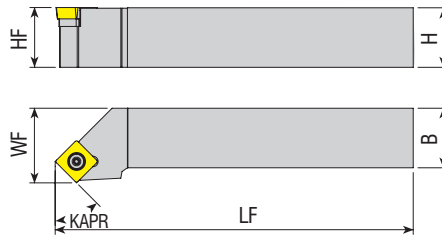

Takım Kodu Ordering Code Код для заказа	Stok Stock Наличие		Takım Ölçüleri (mm) Dimension (mm) Размеры (мм)				Kesici Uç Insert Пластина	Yedek Parçaları / Spare Parts / Запасные части			
	R	L	HF=H	B	LF	WF		Sıkma Vidası Screw Зажимной винт	Altlık Shim Опорная пластина	Altlık Vidası Shim Screw Винт опорной пластины	Tork Anahtar Torx Key Торх Ключ
SSSCR/L 1212 F09	●	●	12	12	80	16	SC.T 09T3..	4015-M3.5x11	-	-	80-T15
1616 H09	●	●	16	16	100	20		4015-M3.5x14	AASN-2-0001	AAV-06-M3.5x11	
2020 K09	●	●	20	20	125	25		4020-M4.5x12		AAV-10-M4.5x8	
1616 H12	●	●	16	16	100	20	SC.T 1204..	1020-M4.5x16	AASN-2-0004	AAV-07-M4.5x13	80-T20
2020 K12	●	●	20	20	125	25					
2525 M12	●	●	25	25	150	32					

R: Sağ / Right / Правый L: Sol / Left / Левый
● Stokta / In Stock / В наличии ○ Stokta Yok / Non Stock Item / Нет в наличии

Sipariş Örneği/Ordering Example/Образец заказа
1 ad./pcs./шт. SSDCN 1212 F09

S-SİSTEM DIŞ TORNA KATERLERİ

S-SYSTEM EXTERNAL TURNING TOOLHOLDERS

S-ТИП ДЕРЖАВКИ ДЛЯ СТАНКОВ АВТОМАТОВ ШВЕЙЦАРСКОГО ТИПА

KAPR=90°

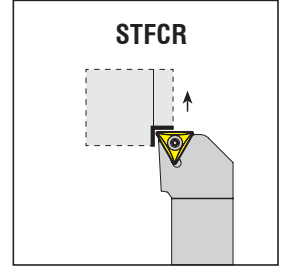
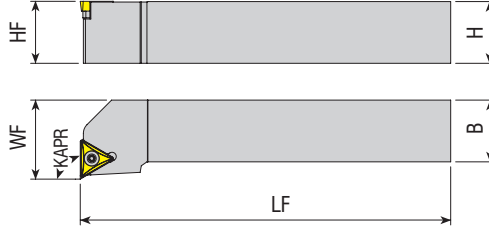

Takım Kodu
Ordering Code
Код для заказа

Stok Stock Наличие	Takım Ölçüleri (mm) Dimension (mm) Размеры (мм)					Kesici Uç Insert Пластина	Yedek Parçaları / Spare Parts / Запасные части				
	R	L	HF=H	B	LF		WF	Sıkma Vidası Screw Зажимной винт	Aitlik Shim Опорная пластина	Aitlik Vidası Shim Screw Винт опорной пластины	Tork Anahtar Torx Key Торх Ключ
STFGR/L 0808 E09	○	○	08	08	70	10	TC.T 0902..	3007-M2.2x4.6	-	-	82-T07
1010 E09	●	●	10	10	70	12					
1212 F11	●	●	12	12	80	16					
1616 H11	●	●	16	16	100	20	TC.T 1102..	4008-M2.5x6	-	-	82-T08
1616 H16	●	●	16	16	100	20					
2020 K16	●	●	20	20	125	25	TC.T 16T3..	4015-M3.5x14	AATN-2-0001	AAV-06-M3.5x11	80-T15
2525 M16	●	●	25	25	150	32					
3232 P16	●	●	32	32	170	40					

KAPR=90°

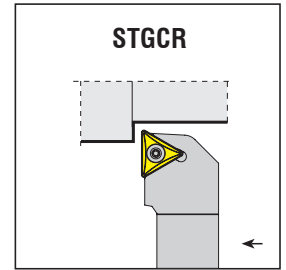
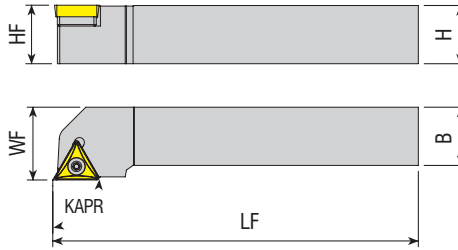
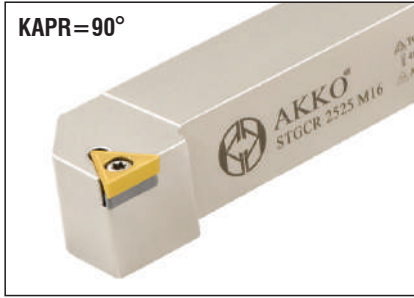

Takım Kodu
Ordering Code
Код для заказа

Stok Stock Наличие	Takım Ölçüleri (mm) Dimension (mm) Размеры (мм)					Kesici Uç Insert Пластина	Yedek Parçaları / Spare Parts / Запасные части				
	R	L	HF=H	B	LF		WF	Sıkma Vidası Screw Зажимной винт	Aitlik Shim Опорная пластина	Aitlik Vidası Shim Screw Винт опорной пластины	Tork Anahtar Torx Key Торх Ключ
STGCR/L 0808 E09	●	●	08	08	70	10	TC.T 0902..	3007-M2.2x4.6	-	-	82-T07
1010 E09	●	●	10	10	70	12					
1212 F11	●	●	12	12	80	16					
1616 H11	●	●	16	16	100	20	TC.T 1102..	4008-M2.5x6	-	-	82-T08
1616 H16	●	●	16	16	100	20					
2020 K16	●	●	20	20	125	25	TC.T 16T3..	4015-M3.5x14	AATN-2-0001	AAV-06-M3.5x11	80-T15
2525 M16	●	●	25	25	150	32					
3232 P16	●	●	32	32	170	40					

R: Sağ / Right / Правый L: Sol / Left / Левый
● Stokta / In Stock / В наличии ○ Stokta Yok / Non Stock Item / Нет в наличии

Sipariş Örneği/Ordering Example/Образец заказа
1 ad./pcs./шт. STFGR 0808 E09

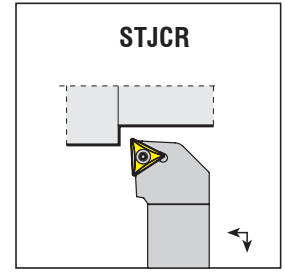
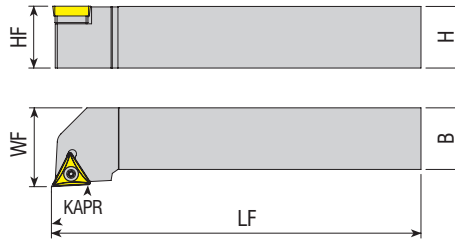
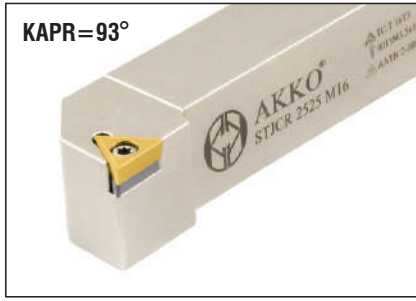

Takım Kodu
Ordering Code
Код для заказа

Stok Stock Наличие	Takım Ölçüleri (mm) Dimension (mm) Размеры (мм)					Kesici Uç Insert Пластина	Yedek Parçaları / Spare Parts / Запасные части				
	R	L	HF=H	B	LF		WF	Sıkma Vidası Screw Зажимной винт	Aitlik Shim Опорная пластина	Aitlik Vidası Shim Screw Винт опорной пластины	Tork Anahtar Torx Key Торх Ключ
STJCR/L 0808 E09	●	●	08	08	70	10	TC.T 0902..	3007-M2.2x4.6	-	-	82-T07
1010 E09	●	●	10	10	70	12					
1212 F11	●	●	12	12	80	16	TC.T 1102..	4008-M2.5x6	-	-	82-T08
1616 H11	●	●	16	16	100	20					
1616 H16	●	●	16	16	100	20					
2020 K16	●	●	20	20	125	25	TC.T 16T3..	4015-M3.5x14	AATN-2-0001	AAV-06-M3.5x11	80-T15
2525 M16	●	●	25	25	150	32					
3232 P16	●	●	32	32	170	40					

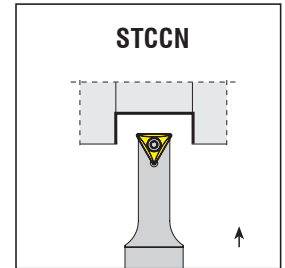
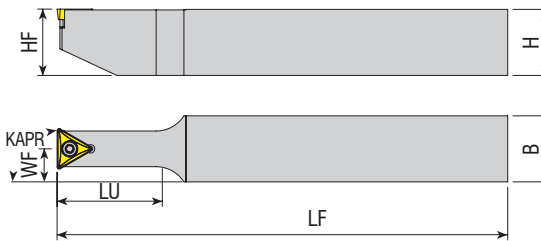

Takım Kodu
Ordering Code
Код для заказа

Stok Stock Наличие	Takım Ölçüleri (mm) Dimension (mm) Размеры (мм)						Kesici Uç Insert Пластина	Yedek Parçaları / Spare Parts / Запасные части			
	HF=H	B	LF	WF	LU	Sıkma Vidası Screw Зажимной винт		Aitlik Shim Опорная пластина	Aitlik Vidası Shim Screw Винт опорной пластины	Tork Anahtar Torx Key Торх Ключ	
STCCN 2020 L11	●	20	20	140	10	50	TC.T 1102..	4008-M2.5x6	-	-	82-T08
1616 K16	●	16	16	125	8	24					
2020 M16	●	20	20	150	10	30	TC.T 16T3..	4015-M3.5x14	AATN-2-0001	AAV-06-M3.5x11	80-T15
2525 P16	●	25	25	170	12.5	37.5					
3232 R16	●	32	32	200	16	48					
2525 P22	●	25	25	170	12.5	80	TC.T 2204..	4020-M4.5x12	-	-	80-T20

R: Sağ / Right / Правый L: Sol / Left / Левый
● Stokta / In Stock / В наличии ○ Stokta Yok / Non Stock Item / Нет в наличии

Sipariş Örneği/Ordering Example/Образец заказа
1 ad./pcs./шт. STJCR 0808 E09

S-SİSTEM DIŞ TORNA KATERLERİ
S-SYSTEM EXTERNAL TURNING TOOLHOLDERS
S-ТИП ДЕРЖАВКИ ДЛЯ СТАНКОВ АВТОМАТОВ ШВЕЙЦАРСКОГО ТИПА

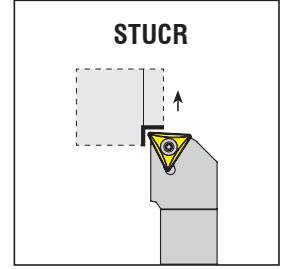
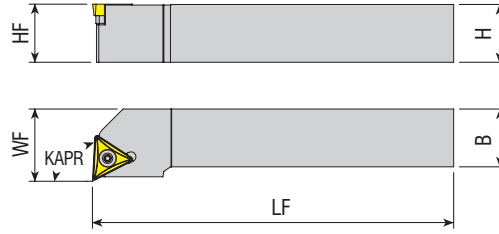

Takım Kodu Ordering Code Код для заказа	Stok Stock Наличие		Takım Ölçüleri (mm) Dimension (mm) Размеры (мм)				Kesici Uç Insert Пластина	Yedek Parçaları / Spare Parts / Запасные части			
	R	L	HF=H	B	LF	WF		Sıkma Vidası Screw Зажимной винт	Altık Shim Опорная пластина	Altık Vidası Shim Screw Винт опорной пластины	Tork Anahtar Torx Key Торх Ключ
STUCR/L 0808 E09	●	●	08	08	70	10	TC.T 0902..				82-T07
1010 E09	●	●	10	10	70	12					
1212 F11	●	●	12	12	80	16					
1616 H11	●	●	16	16	100	20	TC.T 1102..				82-T08
1616 H16	○	○	16	16	100	20					
2020 K16	●	●	20	20	125	25	TC.T 16T3..				80-T15
2525 M16	●	●	25	25	150	32					
3232 P16	●	●	32	32	170	40					

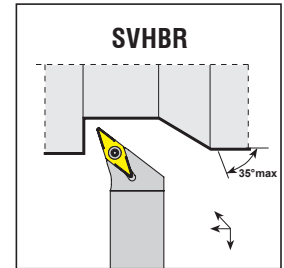
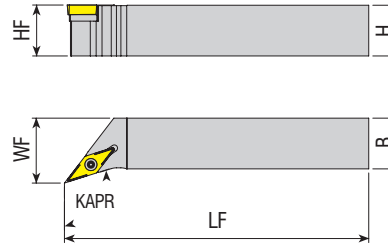
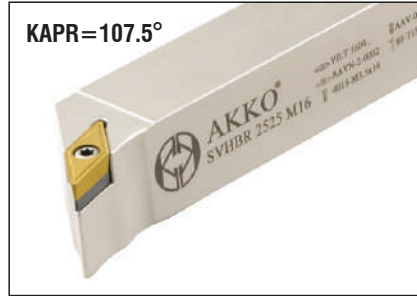

Takım Kodu Ordering Code Код для заказа	Stok Stock Наличие		Takım Ölçüleri (mm) Dimension (mm) Размеры (мм)				Kesici Uç Insert Пластина	Yedek Parçaları / Spare Parts / Запасные части			
	R	L	HF=H	B	LF	WF		Sıkma Vidası Screw Зажимной винт	Altık Shim Опорная пластина	Altık Vidası Shim Screw Винт опорной пластины	Tork Anahtar Torx Key Торх Ключ
SVHBR/L 1212 F11	●	●	12	12	80	16	VB.T 1103..				82-T08
1616 H11	●	●	16	16	100	20					
2020 K11	●	●	20	20	125	25					
2020 K16	●	●	20	20	125	25	VB.T 1604..				80-T15
2525 M16	●	●	25	25	150	32					
3232 P16	●	●	32	32	170	40					

R: Sağ / Right / Правый L: Sol / Left / Левый
 ● Stokta / In Stock / В наличии ○ Stokta Yok / Non Stock Item / Нет в наличии

Sipariş Örneği/Ordering Example/Образец заказа
 1 ad./pcs./шт. STUCR 0808 E09

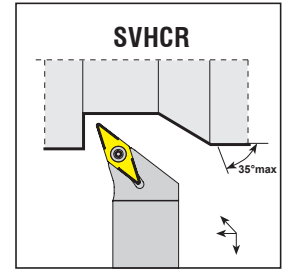
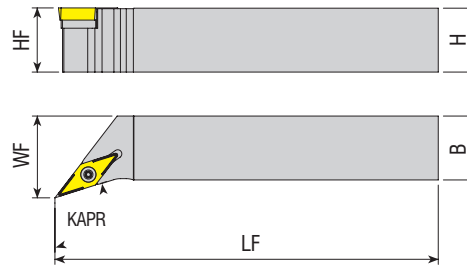
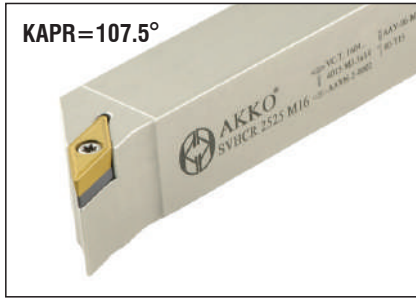

Takım Kodu
Ordering Code
Код для заказа

Stok Stock Наличие	Takım Ölçüleri (mm) Dimension (mm) Размеры (мм)					Kesici Uç Insert Пластина	Yedek Parçaları / Spare Parts / Запасные части				
	R	L	HF=H	B	LF		WF	Sıkma Vidası Screw Зажимной винт	Altlık Shim Опорная пластина	Altlık Vidası Shim Screw Винт опорной пластины	Tork Anahtar Torx Key Торх Ключ
							VC.T 1103..	4008-M2.5x6	-	-	82-T08
							VC.T 1604..	4015-M3.5x14	AAVN-2-0002	AAV-06-M3.5x11	80-T15

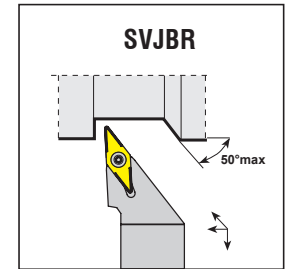
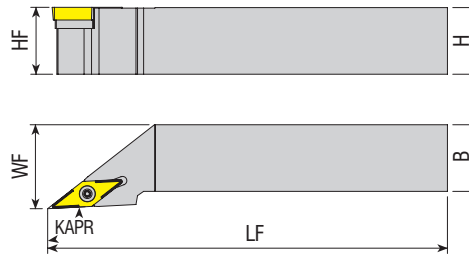

Takım Kodu
Ordering Code
Код для заказа

Stok Stock Наличие	Takım Ölçüleri (mm) Dimension (mm) Размеры (мм)					Kesici Uç Insert Пластина	Yedek Parçaları / Spare Parts / Запасные части				
	R	L	HF=H	B	LF		WF	Sıkma Vidası Screw Зажимной винт	Altlık Shim Опорная пластина	Altlık Vidası Shim Screw Винт опорной пластины	Tork Anahtar Torx Key Торх Ключ
							VB.T 1103..	4008-M2.5x6	-	-	82-T08
							VB.T 1604..	4015-M3.5x12		AAV-08-M3.5x8	
							VB.T 1604..	4015-M3.5x14	AAVN-2-0002	AAV-06-M3.5x11	80-T15

R: Sağ / Right / Правый L: Sol / Left / Левый
● Stokta / In Stock / В наличии ○ Stokta Yok / Non Stock Item / Нет в наличии

Sipariş Örneği/Ordering Example/Образец заказа
1 ad./pcs./шт. SVHCR 1212 F11

S-SİSTEM DIŞ TORNA KATERLERİ
S-SYSTEM EXTERNAL TURNING TOOLHOLDERS
S-ТИП ДЕРЖАВКИ ДЛЯ СТАНКОВ АВТОМАТОВ ШВЕЙЦАРСКОГО ТИПА

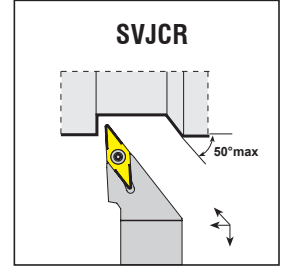
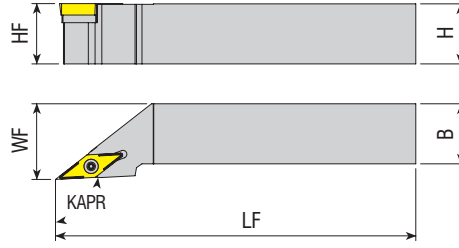

Takım Kodu Ordering Code Код для заказа	Stok Stock Наличие		Takım Ölçüleri (mm) Dimension (mm) Размеры (мм)				Kesici Uç Insert Пластина	Yedek Parçaları / Spare Parts / Запасные части				
	R	L	HF=H	B	LF	WF		Sıkma Vidası Screw Зажимной винт	Altılık Shim Опорная пластина	Altılık Vidası Shim Screw Винт опорной пластины	Tork Anahtar Torx Key Торх Ключ	
	●	○										
SVJCR/L 1212 F11	●	●	12	12	80	16	VC.T 1103..	4008-M2.5x6	-	-	82-T08	
1616 H11	●	●	16	16	100	20						
2020 K11	●	●	20	20	125	25						
2525 M11	●	●	25	25	150	32						
1212 F16	●	●	12	12	80	16	VC.T 1604..	4015-M3.5x11	AAVN-2-0002	AAV-06-M3.5x11	80-T15	
2020 K16	●	●	20	20	125	25		4015-M3.5x14				
2525 M16	●	●	25	25	150	32						
3232 P16	●	●	32	32	170	40						

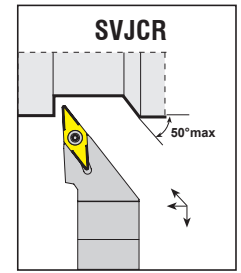
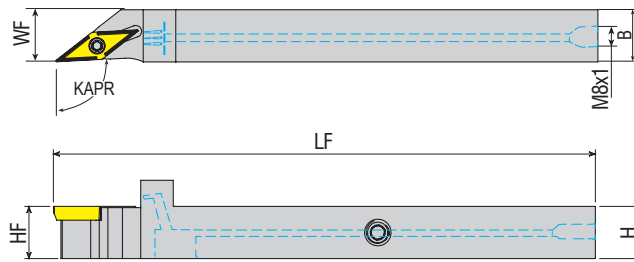
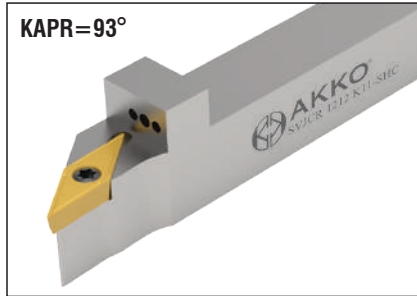

Takım Kodu Ordering Code Код для заказа	Stok Stock Наличие		Takım Ölçüleri (mm) Dimension (mm) Размеры (мм)				Kesici Uç Insert Пластина	Yedek Parçaları / Spare Parts / Запасные части					
	R	L	HF=H	B	LF	WF		Sıkma Vidası Screw Зажимной винт	Altılık Shim Опорная пластина	Altılık Vidası Shim Screw Винт опорной пластины	Sızdırmaz Vida Threaded Pin Gewindestift	Anahtar Allen Key Innensechskantschlüssel	Tork Anahtar Torx Key Торх Ключ
	●	○											
SVJCR/L 1212 K11-SHC	●	○	12	12	125	12	VC.T 1103..	4008-M2.5x6	-	-	2703-M6X4	AAL-03-3	82-T08
1616 K11-SHC	●	○	16	16	125	16					2704-M8X1X5	AAL-05-4	

R: Sağ / Right / Правый L: Sol / Left / Левый
 ● Stokta / In Stock / В наличии ○ Stokta Yok / Non Stock Item / Нет в наличии
 ISO Ucuna Uygunudur. / Compatible with ISO Insert. / Под пластину ISO.

Sipariş Örneği/Ordering Example/Образец заказа
 1 ad./pcs./шт. SVJCR 1212 F11



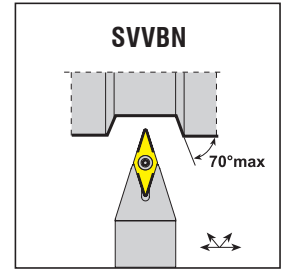
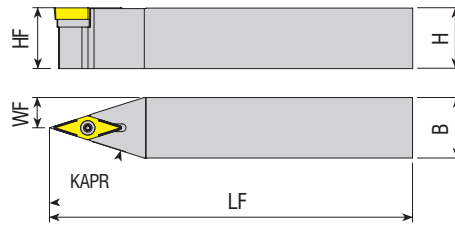

Takım Kodu Ordering Code Код для заказа	Stok Stock Наличие	Takım Ölçüleri (mm) Dimension (mm) Размеры (мм)				Kesici Uç Insert Пластина	Yedek Parçaları / Spare Parts / Запасные части			
		HF=H	B	LF	WF		Sıkma Vidası Screw Зажимной винт	Altlık Shim Опорная пластина	Altlık Vidası Shim Screw Винт опорной пластины	Tork Anahtar Torx Key Торх Ключ
SVVCN 1212 F11	●	12	12	80	06	VB.T 1103..	4008-M2.5x6	-	-	82-T08
1616 H11	●	16	16	100	08					
2020 K11	●	20	20	125	10					
2020 K16	●	20	20	125	10	VB.T 1604..	4015-M3.5x14	AAVN-2-0002	AAV-06-M3.5x11	80-T15
2525 M16	●	25	25	150	12.5					
3232 P16	●	32	32	170	16					

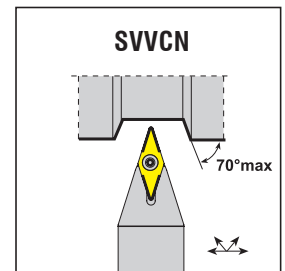
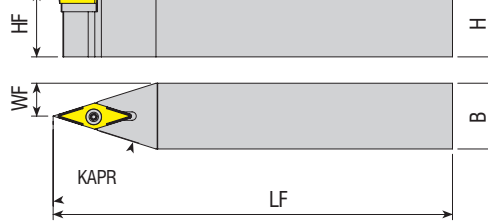

Takım Kodu Ordering Code Код для заказа	Stok Stock Наличие	Takım Ölçüleri (mm) Dimension (mm) Размеры (мм)				Kesici Uç Insert Пластина	Yedek Parçaları / Spare Parts / Запасные части			
		HF=H	B	LF	WF		Sıkma Vidası Screw Зажимной винт	Altlık Shim Опорная пластина	Altlık Vidası Shim Screw Винт опорной пластины	Tork Anahtar Torx Key Торх Ключ
SVVCN 1212 F11	●	12	12	80	06	VC.T 1103..	4008-M2.5x6	-	-	82-T08
1616 H11	●	16	16	100	08					
2020 K11	●	20	20	125	10					
2020 K16	●	20	20	125	10	VC.T 1604..	4015-M3.5x14	AAVN-2-0002	AAV-06-M3.5x11	80-T15
2525 M16	●	25	25	150	12.5					
3232 P16	●	32	32	170	16					

R: Sağ / Right / Правый L: Sol / Left / Левый
● Stokta / In Stock / В наличии ○ Stokta Yok / Non Stock Item / Нет в наличии

Sipariş Örneği/Ordering Example/Образец заказа
1 ad./pcs./шт. SVVCN 1212 F11

S-SİSTEM İSVİÇRE TİPİ KAYAR OTOMAT MAKİNA TAKIMLARI

S-SYSTEM TOOLS FOR SWISS TYPE SLIDING AUTOMATIC LATHES

S-ТИП ДЕРЖАВКИ ДЛЯ СТАНКОВ АВТОМАТОВ ШВЕЙЦАРСКОГО ТИПА

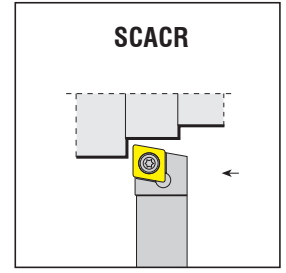
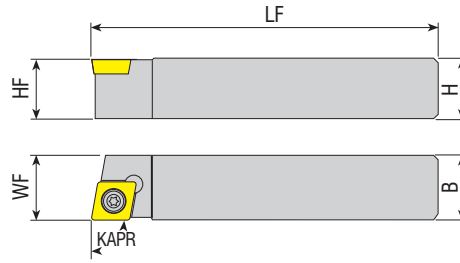
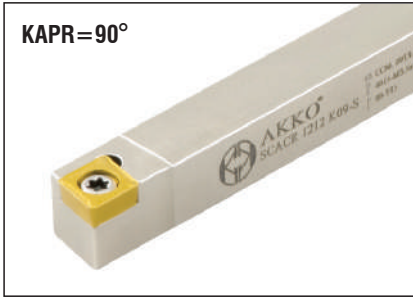

Takım Kodu
Ordering Code
Код для заказа

Stok Stock Наличие	Takım Ölçüleri (mm) Dimension (mm) Размеры (мм)						Kesici Uç Insert Пластина	Yedek Parçaları / Spare Parts / Запасные части			
	R	L	HF=H	B	LF	WF		Sıkma Vidası Screw Зажимной винт	Altlık Shim Опорная пластина	Altlık Vidası Shim Screw Винт опорной пластины	Tork Anahtar Torx Key Торх Ключ
	●	●	08	08	115	08	CC.T 0602..	4008-M2.5x6	-	-	82-T08
SCACR/L 0808 X06-S	●	●	08	08	115	08					
1010 K06-S	●	○	10	10	125	10					
1212 G06-S	●	○	12	12	90	12					
1212 K06-S	●	○	12	12	125	12					
1616 F06-S	○	○	16	16	75	16					
1616 K06-S	○	○	16	16	125	16	CC.T 09T3..	4015-M3.5x11	-	-	80-T15
1212 G09-S	○	○	12	12	90	12					
1212 K09-S	●	●	12	12	125	12					
1616 F09-S	○	○	16	16	75	16					
1616 K09-S	●	●	16	16	125	16					
2020 K09-S	●	●	20	20	125	20					

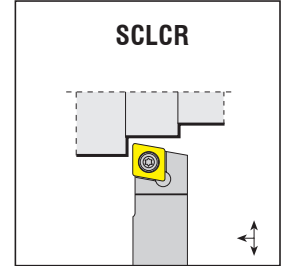
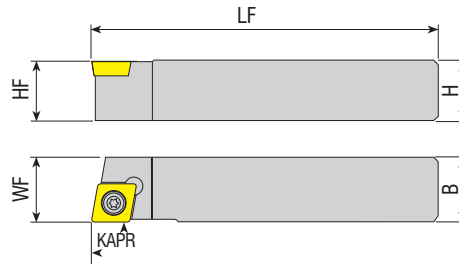
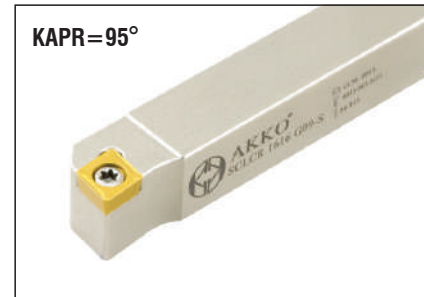

Takım Kodu
Ordering Code
Код для заказа

Stok Stock Наличие	Takım Ölçüleri (mm) Dimension (mm) Размеры (мм)						Kesici Uç Insert Пластина	Yedek Parçaları / Spare Parts / Запасные части			
	R	L	HF=H	B	LF	WF		Sıkma Vidası Screw Зажимной винт	Altlık Shim Опорная пластина	Altlık Vidası Shim Screw Винт опорной пластины	Tork Anahtar Torx Key Торх Ключ
	●	●	08	08	115	08	CC.T 0602..	4008-M2.5x6	-	-	82-T08
SCLCR/L 0808 X06-S	●	●	08	08	115	08					
1010 X06-S	●	○	10	10	115	10					
1212 G06-S	●	○	12	12	90	12					
1212 X06-S	●	○	12	12	130	12					
1212 K06-S	○	●	12	12	125	12					
1616 F06-S	●	○	16	16	75	16	CC.T 09T3..	4015-M3.5x11	-	-	80-T15
1616 X06-S	●	○	16	16	130	16					
1212 G09-S	●	○	12	12	90	12					
1212 X09-S	●	○	12	12	130	12					
1616 F09-S	●	○	16	16	75	16					
1616 G09-S	●	○	16	16	90	16					
1616 X09-S	●	○	16	16	115	16					
2020 X09-S	●	○	20	20	120	20					

R: Sağ / Right / Правый L: Sol / Left / Левый

● Stokta / In Stock / В наличии ○ Stokta Yok / Non Stock Item / Нет в наличии

Sipariş Örneği/Ordering Example/Образец заказа

1 ad./pcs./шт. SCACR 0808 X06-S



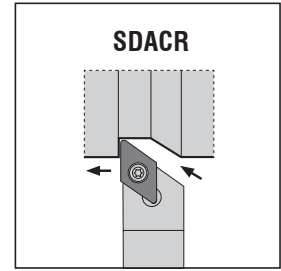
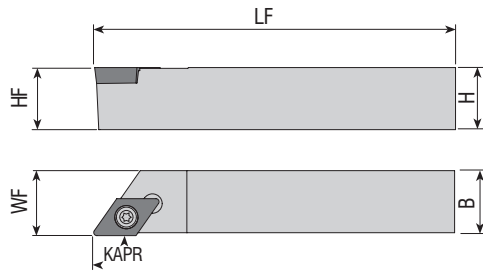

Takım Kodu
Ordering Code
Код для заказа

Stok
Stock
Наличие

Takım Ölçüleri (mm)
Dimension (mm)
Размеры (мм)

Kesici Uç
Insert
Пластина

Yedek Parçaları / Spare Parts / Запасные части

Sıkma Vidası
Screw
Зажимной винт

Altlık
Shim
Опорная пластина

Altlık Vidası
Shim Screw
Винт опорной пластины

Tork Anahtar
Torx Key
Торх Ключ

R L

HF=H

B

LF

WF

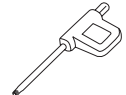

SDACR/L 0808 X07-S

● ●

08

08

115

08

1010 K07-S

● ●

10

10

125

10

1212 G07-S

○ ○

12

12

90

12

1212 K07-S

● ●

12

12

125

12

1616 F07-S

● ○

16

16

75

16

1616 K07-S

● ●

16

16

125

16

1212 G11-S

○ ○

12

12

90

12

1212 K11-S

● ●

12

12

125

12

1616 F11-S

● ●

16

16

75

16

1616 K11-S

● ●

16

16

125

16

2020 K11-S

● ●

20

20

125

20

DC.T 0702..

4008-M2.5x6

-

-

82-T08

DC.T 11T3..

4015-M3.5x11

-

-

80-T15

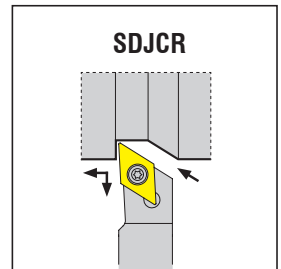
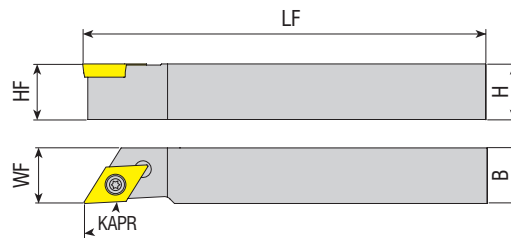
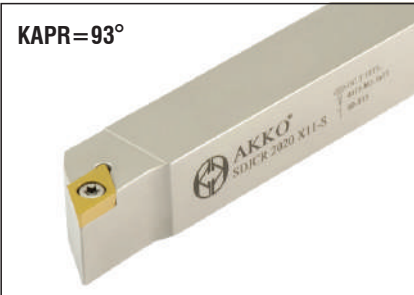

Takım Kodu
Ordering Code
Код для заказа

Stok
Stock
Наличие

Takım Ölçüleri (mm)
Dimension (mm)
Размеры (мм)

Kesici Uç
Insert
Пластина

Yedek Parçaları / Spare Parts / Запасные части

Sıkma Vidası
Screw
Зажимной винт

Altlık
Shim
Опорная пластина

Altlık Vidası
Shim Screw
Винт опорной пластины

Tork Anahtar
Torx Key
Торх Ключ

R L

HF=H

B

LF

WF

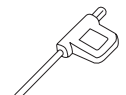

SDJCR/L 0808 X07-S

● ○

08

08

115

08

1010 X07-S

● ●

10

10

115

10

1212 G07-S

● ○

12

12

90

12

1212 X07-S

● ●

12

12

130

12

1616 F07-S

● ○

16

16

75

16

1616 X07-S

● ○

16

16

130

16

2020 X07-S

● ○

20

20

120

20

1212 G11-S

● ○

12

12

90

12

1212 X11-S

● ●

12

12

130

12

1212 K11-S

● ●

12

12

125

12

1616 F11-S

● ○

16

16

75

16

1616 X11-S

● ●

16

16

130

16

1616 K11-S

● ●

16

16

125

16

2020 X11-S

● ○

20

20

120

20

DC.T 0702..

4008-M2.5x6

-

-

82-T08

DC.T 11T3..

4015-M3.5x11

-

-

80-T15

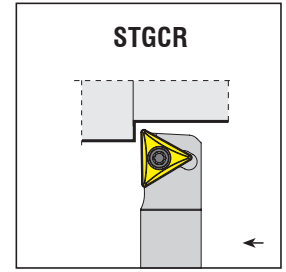
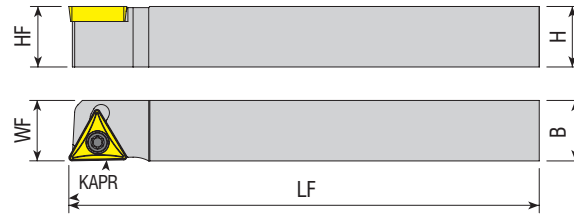
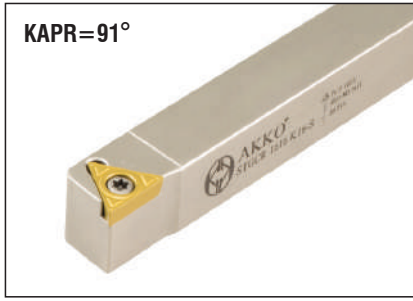

Takım Kodu Ordering Code Код для заказа	Stok Stock Наличие		Takım Ölçüleri (mm) Dimension (mm) Размеры (мм)				Kesici Uç Insert Пластина	Yedek Parçaları / Spare Parts / Запасные части			
	R	L	HF=H	B	LF	WF		Sıkma Vidası Screw Зажимной винт	Altlık Shim Опорная пластина	Altlık Vidası Shim Screw Винт опорной пластины	Tork Anahtar Torx Key Торх Ключ
STGCR/L 1216 K11-S 1616 K11-S	●	○	12	16	125	16	TC.T 1102..	4008-M2.5x6	-	-	82-T08
1216 K16-S 1616 K16-S	●	○	12	16	125	16					

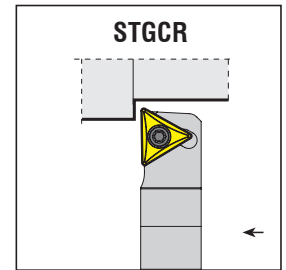
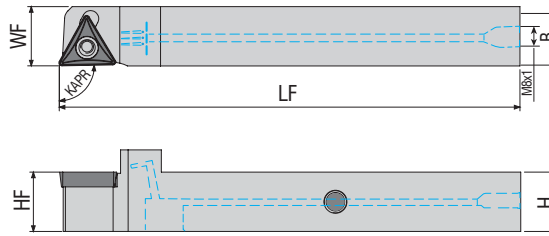

Takım Kodu Ordering Code Код для заказа	Stok Stock Наличие		Takım Ölçüleri (mm) Dimension (mm) Размеры (мм)				Kesici Uç Insert Пластина	Yedek Parçaları / Spare Parts / Запасные части			
	R	L	HF=H	B	LF	WF		Sıkma Vidası Screw Зажимной винт	Sızdırmaz Vida Threaded Pin Резьбовой Винт	Anahtar Allen Key Ключ	Tork Anahtar Torx Key Торх Ключ
STGCR/L 1216 K16-SHC 1616 K16-SHC	●	○	12	16	125	16	TC.T 16T3..	4015-M3.5x11	2703-M6X4	AAL-03-3	80-T15
	●	○	16	16	125	16			2704-M8X1X5	AAL-05-4	

R: Sağ / Right / Правый L: Sol / Left / Левый
● Stokta / In Stock / В наличии ○ Stokta Yok / Non Stock Item / Нет в наличии
ISO Ucuna Uygunudur. / Compatible with ISO Insert. / Под пластину ISO.

Sipariş Örneği/Ordering Example/Образец заказа
1 ad./pcs./шт. STGCR 1216 K11-S

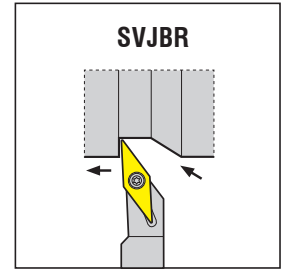
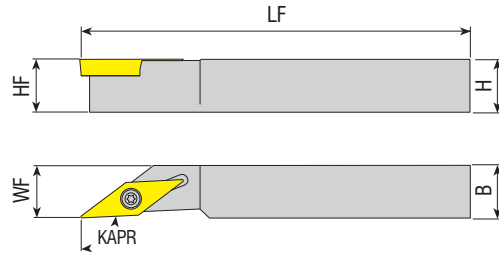

Takım Kodu
Ordering Code
Код для заказа

Stok
Stock
Наличие

Takım Ölçüleri (mm)
Dimension (mm)
Размеры (мм)

Kesici Uç
Insert
Пластина

Yedek Parçaları / Spare Parts / Запасные части

Sıkma Vidası
Screw
Зажимной винт

Altlık
Shim
Опорная пластина

Altlık Vidası
Shim Screw
Винт опорной пластины

Tork Anahtar
Torx Key
Торх Ключ

R L

HF=H B

LF

WF



SVJBR/L 1616 K11-S

● ●

16 16

125

16

VB.T 1103..

4008-M2.5x6

-

-

82-T08

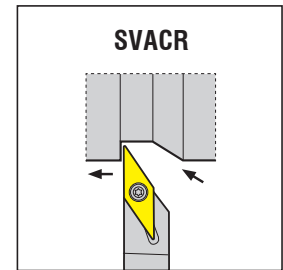
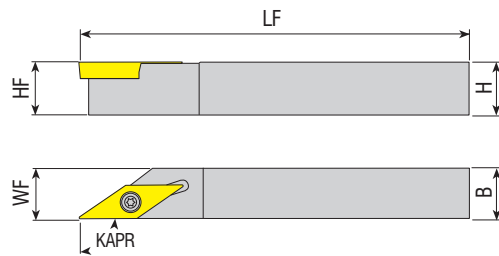

Takım Kodu
Ordering Code
Код для заказа

Stok
Stock
Наличие

Takım Ölçüleri (mm)
Dimension (mm)
Размеры (мм)

Kesici Uç
Insert
Пластина

Yedek Parçaları / Spare Parts / Запасные части

Sıkma Vidası
Screw
Зажимной винт

Altlık
Shim
Опорная пластина

Altlık Vidası
Shim Screw
Винт опорной пластины

Tork Anahtar
Torx Key
Торх Ключ

R L

HF=H B

LF

WF



SVACR/L 0808 X11-S

○ ○

08 08

115

08

1010 K11-S

● ○

10 10

125

10

1212 G11-S

○ ○

12 12

90

12

1212 K11-S

● ●

12 12

125

12

1616 F11-S

○ ○

16 16

75

16

1616 K11-S

● ●

16 16

125

16

2020 K11-S

● ●

20 20

125

20

1212 K16-S

● ●

12 12

125

12

1616 K16-S

● ●

16 16

125

16

VC.T 1604..

4015-M3.5x11

80-T15

R: Sağ / Right / Правый L: Sol / Left / Левый
● Stokta / In Stock / В наличии ○ Stokta Yok / Non Stock Item / Нет в наличии

Sipariş Örneği/Ordering Example/Образец заказа
1 ad./pcs./шт. SVJBR 1616 K11-S

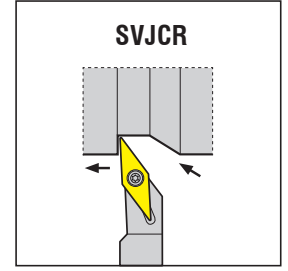
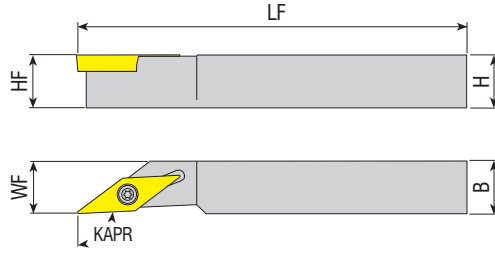

Takım Kodu Ordering Code Код для заказа	Stok Stock Наличие		Takım Ölçüleri (mm) Dimension (mm) Размеры (мм)				Kesici Uç Insert Пластина	Yedek Parçaları / Spare Parts / Запасные части			
	R	L	HF=H	B	LF	WF		Sıkma Vidası Screw Зажимной винт	Altık Shim Опорная пластина	Altık Vidası Shim Screw Винт опорной пластины	Tork Anahtar Torx Key Торх Ключ
SVJCR/L 0808 X11-S	●	○	08	08	115	08	VC.T 1103..	4008-M2.5x6	-	-	82-T08
1010 K11-S	●	○	10	10	125	10					
1212 G11-S	●	○	12	12	90	12					
1212 K11-S	●	○	12	12	125	12					
1616 F11-S	○	○	16	16	75	16					
1616 K11-S	●	○	16	16	125	16					
2020 K11-S	○	○	20	20	125	20					

SEC TOOLS

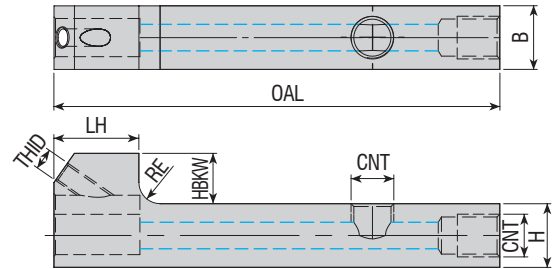

Takım Kodu Ordering Code Код для заказа	Stok Stock Наличие	Takım Ölçüleri (mm) Dimension (mm) Размеры (мм)								Yedek Parçaları / Spare Parts / Запасные части		
		H	B	RE	HBKW	LH	OAL	CNT	THID	Sızdırmaz Vida Threaded Pin Резьбовой Винт	Montaj Vidası Mounting Screw Монтажный винт	Anahtar Allen Key Ключ
ASTB-1212-L84-H	●	12	12	4	9.5	16	84	M8X1X5	M4x0.7	2704-M8X1X5	2503-M4x12-C	AAL-03-3
ASTB-1616-L90-H	●	16	16	1	5.5	16	90	M8X1X5	M4x0.7			

R: Sağ / Right / Правый L: Sol / Left / Левый
● Stokta / In Stock / В наличии ○ Stokta Yok / Non Stock Item / Нет в наличии

Sipariş Örneği/Ordering Example/Образец заказа
1 ad./pcs./шт. SVJCR 0808 X11-S

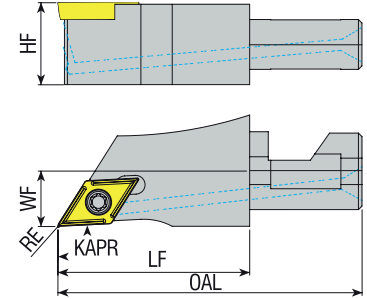
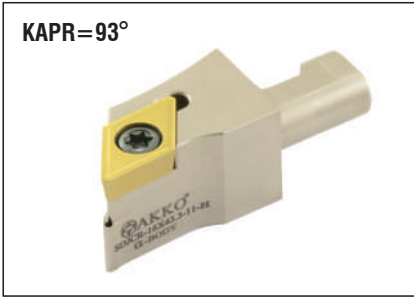

Takım Kodu Ordering Code Код для заказа	Stok Stock Наличие		Takım Ölçüleri (mm) Dimension (mm) Размеры (мм)					Kesici Uç Insert Пластина	Yedek Parçaları / Spare Parts / Запасные части		
	R	L	HF	WF	RE	LF	OAL		Sıkma Vidası Screw Зажимной винт	Tork Anahtar Torx Key Торх Ключ	
SDJCR/L-12X43.3-07	●	●	11.8	8	0.2	27.3	43.3	DC.T 070202		4008-M2.5x6	
12X43.3-07-H	●	●	11.8	8	0.2	27.3	43.3				
16X43.3-07	●	●	15.8	8	0.2	27.3	43.3				
16X43.3-07-H	●	●	15.8	8	0.2	27.3	43.3				
12X43.3-11	●	●	11.8	8	0.2	27.3	43.3	DC.T 11T302		4015-M3.5x9	80-T15
12X43.3-11-H	●	●	11.8	8	0.2	27.3	43.3				
16X43.3-11	●	●	15.8	8	0.2	27.3	43.3				
16X43.3-11-H	●	●	15.8	8	0.2	27.3	43.3				

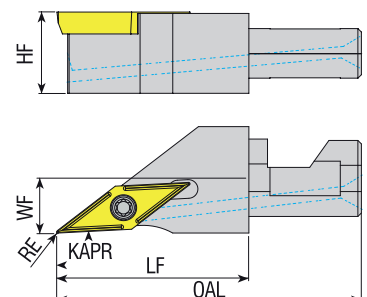

Takım Kodu Ordering Code Код для заказа	Stok Stock Наличие		Takım Ölçüleri (mm) Dimension (mm) Размеры (мм)					Kesici Uç Insert Пластина	Yedek Parçaları / Spare Parts / Запасные части		
	R	L	HF	WF	RE	LF	OAL		Sıkma Vidası Screw Зажимной винт	Tork Anahtar Torx Key Торх Ключ	
SVJCR/L-12X43.3-11	●	●	11.8	8	0.2	27.3	43.3	VC.T 110302			
12X43.3-11-H	●	●	11.8	8	0.2	27.3	43.3				
16X43.3-11	●	●	15.8	8	0.2	27.3	43.3				
16X43.3-11-H	●	●	15.8	8	0.2	27.3	43.3				

R: Sağ / Right / Правый L: Sol / Left / Левый
 ● Stokta / In Stock / В наличии ○ Stokta Yok / Non Stock Item / Нет в наличии

Sipariş Örneği/Ordering Example/Образец заказа
 1 ad./pcs./шт. SDJCR-12X43.3-07

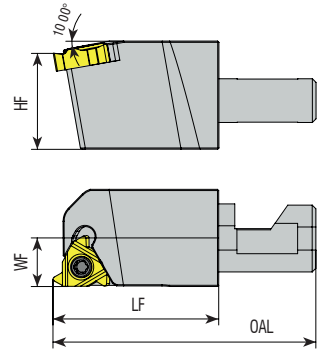
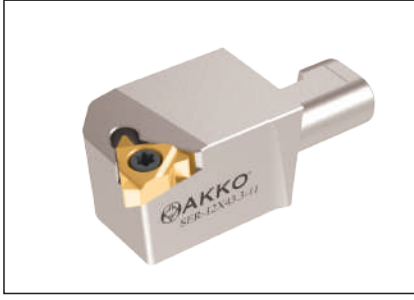

Yedek Parçaları / Spare Parts / Запасные части

Takım Kodu Ordering Code Код для заказа	Stok Stock Наличие		Takım Ölçüleri (mm) Dimension (mm) Размеры (мм)				Kesici Uç Insert Пластина	Sıkma Vidası Screw Зажимной винт	Sağ Altlık Right Shim правая подкладная пластина	Sol Altlık Left Shim левая подкладная пластина	Altlık Vidası Shim Screw Винт опорной пластины	Altlık Vidası Pulu Shim Screw Ring Винт опорной пластины/пту	Tork Anahtar Torx Key Торх Ключ
	R	L	OAL	LF	WF	HF							
SER/L-12x43.3-11	●	●	43.3	27.3	8	11.8			-	-	-	-	
SER/L-16x43.3-11	●	●	43.3	27.3	8	15.8	11 ER/EL	4008-M2.5x6	-	-	-	-	82-T08
TER/L-16x43.3-16	●	●	43.3	27.3	8	15.8	16 ER/EL	1710-U5-40x12.2	ATS-16E	ATS-16I	AAV-11-U5-40x4.5	ABPL-03	82-T10

R: Sağ / Right / Правый L: Sol / Left / Левый

● Stokta / In Stock / В наличии ○ Stokta Yok / Non Stock Item / Нет в наличии

Sipariş Örneği/Ordering Example/Образец заказа

1 ad./pcs./шт. SER/L-12x43.3-11

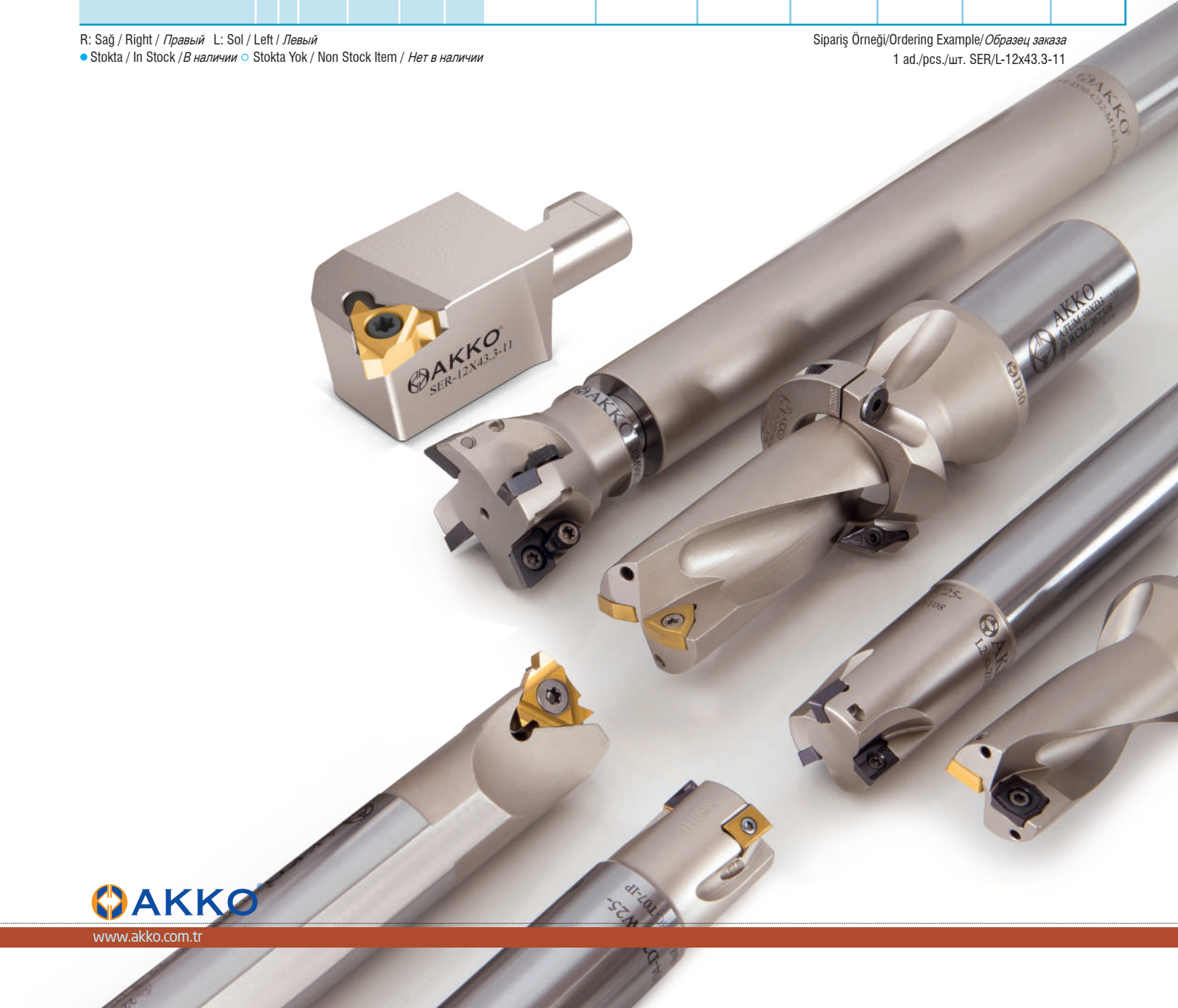

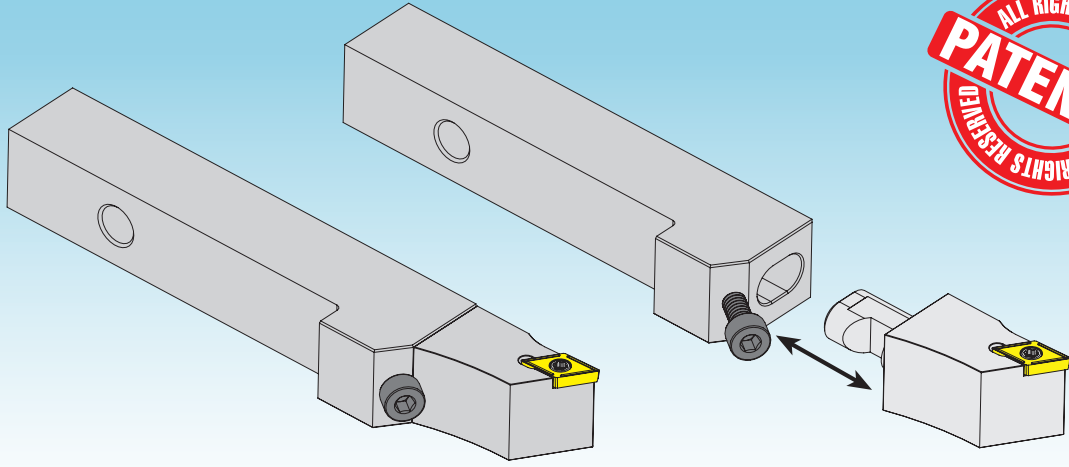

Takım tutucuyu, bağlama ünitesinden sökme zorunluğu kalmadan hızlıca deęiřtirin!

Quick change, without having to remove the tool-holder from the gang !

Быстрое извлечение картриджа для замены пластины. При этом, не требуется снимать державку из резцедержателя.

Makina dıřında ön ayar yapmak mumkun.

Presetting is possible outside of the machine.

Возможность предварительной настройке не в станке

Çok hassas montaj.

Ultra precise fitting.

Ультраточное соединение при сборке

Rijit sabitleme.

Rigid fixation.

Жесткая фиксация

Takım tutucu bölümü: 12x12 ve 16x16 mm.

Tool-holder section : 12x12 and 16x16 mm.

Размер секции для держателя инструмена 12x12 и 16x16мм

Saę ve sol uçlar kullanılır.

Left and right inserts available.

Используются левые и правые пластины

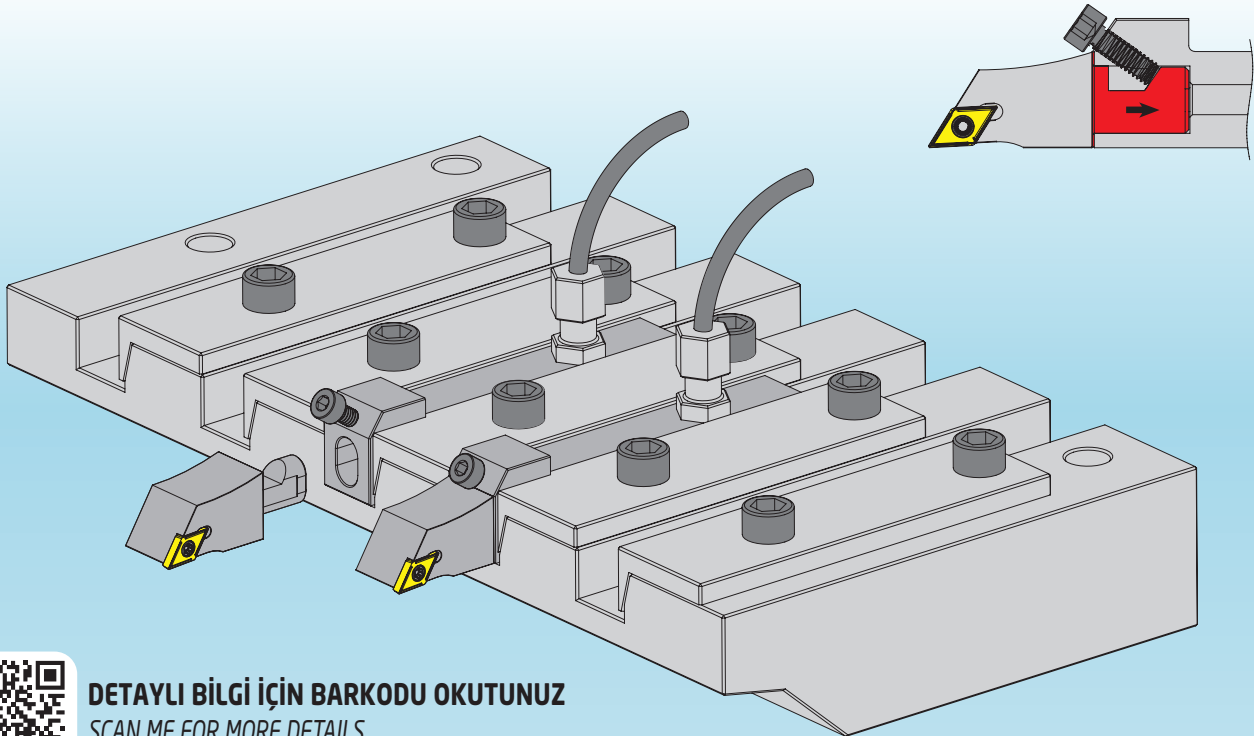

DETAYLI BİLGİ İÇİN BARKODU OKUTUNUZ

SCAN ME FOR MORE DETAILS

ПРОСКАНИРУЙТЕ ДЛЯ ПОЛУЧЕНИЯ БОЛЕЕ ПОДРОБНОЙ ИНФОРМАЦИИ



DELİK TORNA TAKIMLARI
INTERNAL TURNING TOOLHOLDERS
РАСТОЧНЫЕ ДЕРЖАВКИ





S
1

25
2

S
3

P
4

C
5

L
6

N
7

R
8

12
9

C
10

1 Takım Malzemesi / Type of Boring Bar / Тип скучного бара вставки

"A" Yekpare çelik gövde soğutma suyu kanallı / "A" Solid steel with coolant hole
"A" Расточная державка из твердой стали с подвожом СОЖ
"E" Çelik başlıkla sert metal gövde ve soğutma suyu kanallı / "E" Carbide bar with fixed steel head and coolant hole
"E" Расточная державка из твердосплавного карбида с подвожом СОЖ
"C" Karbür Şaft / "C" Carbide shank / "C" Расточная державка из твердосплавного карбида
"S" Çelik Şaft / "S" Steel shank / "S" Расточная державка из твердой стали

2 Şaft Çapı / Shank Diameter / Диаметр хвостовика

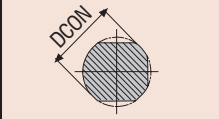

3 Şaft Boyu / Shank Length / Длина хвостовика

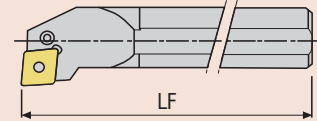

			(mm)
A - 32	H - 100	Q - 180	x-special
B - 40	J - 110	R - 200	
C - 50	K - 125	S - 250	
D - 60	L - 140	T - 300	
E - 70	M - 150	U - 350	
F - 80	N - 160	V - 400	
G - 90	P - 170	W - 450	

4 Sıkma Tipi / Method of Mounting of Insert / Способ монтажа вставки

Deliksiz Üstten Sıkma Top Clamping Without Hole Прижим сверху без отверстия	Üstten Delikle Sıkma Top and Hole Clamping Прижим сверху с отверстием	Üstten ve Delikten Sıkma Top and Hole Clamping Прижим сверху и поджим за отверстие	Delikten Leveye ile Sıkma Hole Clamping (Lever Lock) Прижим рычагом за отверстие	Vida ile Sıkma Screw on Крепление винтом
C	T	M	P	S

5 Uç Tipi / Type of Insert / Форма пластины

C	D	E
V	R	S
W	K	T

6 Yanaşma Açısı / Tool Holder Shape Bar Geometry / Угол направления

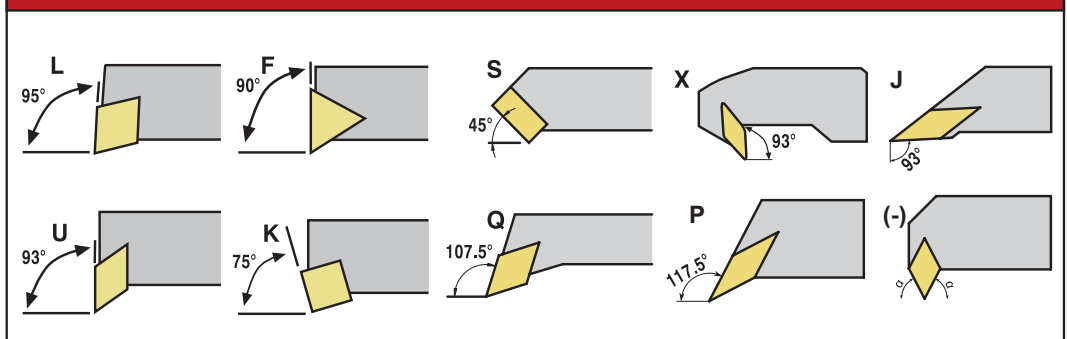

7 Serbest Uç Açısı
Insert Clearance Angle
Задний угол пластины

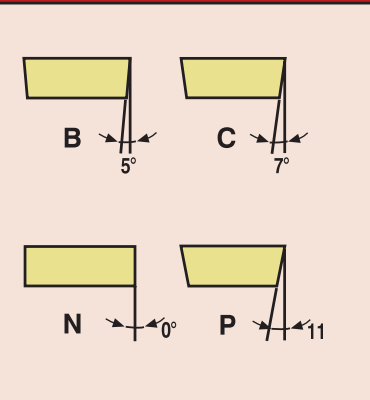

8 Kesme Yönü
Cutting Direction
Направление резания

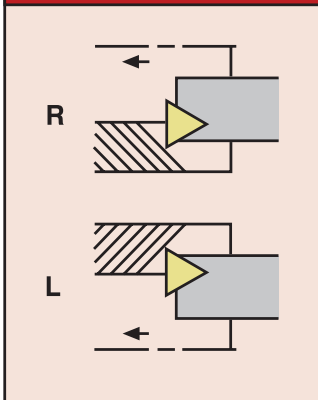

9 Kesme Kenar Uzunluğu
Cutting Edge Length
Длина режущей кромки

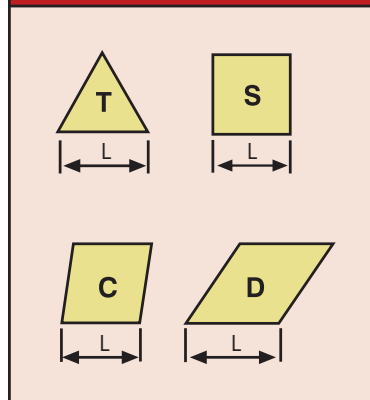

10 Baskı Pabucu
Wedge Clamp
Прижим

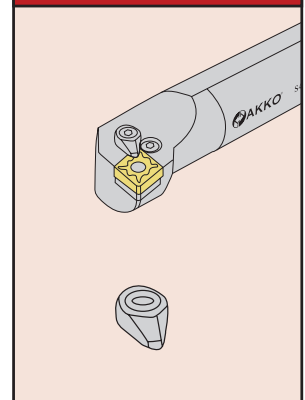



*konusulan
the spoken kalite...
quality...*

T&C-SİSTEM

T&C SİSTEM DELİK TORNA KATERLERİ
T&C SYSTEM BORING BARS
Т И С-ТИП РАСТОЧНЫЕ ДЕРЖАВКИ



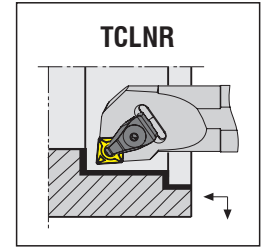
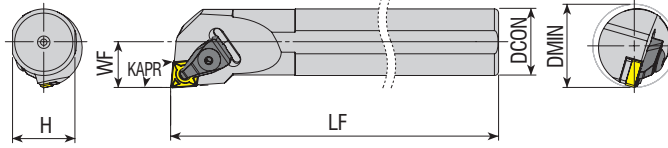

Takım Kodu
Ordering Code
Код для заказа

Stok Stock Наличие	Takım Ölçüleri (mm) Dimension (mm) Размеры (мм)						Kesici Uç Insert Пластина	Yedek Parçaları / Spare Parts / Запасные части							
	R	L	DCON	H	LF	WF		DMIN	Baskı Pabuçu Wedge Clamp Прижим	Pabuç Vidası Clamp Screw Зажимной винт	Altlık Shim Опорная пластина	Altlık Vidası Shim Screw Винт опорной пластины	Segman Ring Кольцо	Pul Stamp Шайба	Anahtar Allen Key Ключ
	●	●	25	23	250	17	≥32	CNM. 0903..	ATK-01	AKV-01-M5x22	AACN-2-0001	AAV-09-M5x9	-		
	●	●	25	23	250	17	≥32					AAV-13-M5x8			
	●	●	32	30	300	22	≥40	CNM. 1204..	ATK-02	AKV-30-M6x22	AACN-3-0001	AAV-02-M5x12	AS-01	ABPL-01	AAL-03-3
	●	●	40	37.5	350	27	≥50								
	●	●	50	47	400	35	≥63								
	●	●	32	30	300	22	≥40								
	●	●	40	37.5	350	27	≥50	CNM. 1606..	ATK-04	AKV-19-M7x25	AACN-3-0002	AAV-05-M6x15	AS-02	ABPL-02	AAL-05-4
	●	●	50	47	400	35	≥63								
new	●	○	25	23	200	17	≥32					AAV-13-M5x8			
new	●	○	40	37.5	300	27	≥50	CNM. 1204..	ATK-02	AKV-30-M6x22	AACN-3-0001	AAV-02-M5x12	AS-01	ABPL-01	AAL-03-3
new	○	●	50	47	400	35	≥63								

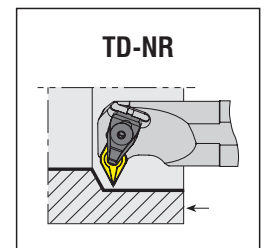
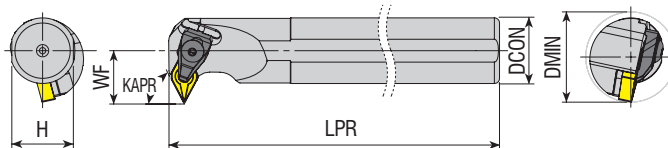

Takım Kodu
Ordering Code
Код для заказа

Stok Stock Наличие	Takım Ölçüleri (mm) Dimension (mm) Размеры (мм)						Kesici Uç Insert Пластина	Yedek Parçaları / Spare Parts / Запасные части							
	R	L	DCON	H	LPR	WF		DMIN	Baskı Pabuçu Wedge Clamp Прижим	Pabuç Vidası Clamp Screw Зажимной винт	Altlık Shim Опорная пластина	Altlık Vidası Shim Screw Винт опорной пластины	Segman Ring Кольцо	Pul Stamp Шайба	Anahtar Allen Key Ключ
	●	●	32	30	300	26	≥44								
	●	●	40	37.5	350	29	≥52	DNM. 1506..	ATK-02	AKV-30-M6x22	AADN-3-0001	AAV-02-M5x12	AS-01	ABPL-01	AAL-03-3
	●	●	50	47	400	35	≥63								

R: Sağ / Right / Правый L: Sol / Left / Левый
● Stokta / In Stock / В наличии ○ Stokta Yok / Non Stock Item / Нет в наличии

Sipariş Örneği/Ordering Example/Образец заказа
1 ad./pcs./шт. S25S TCLNR 09

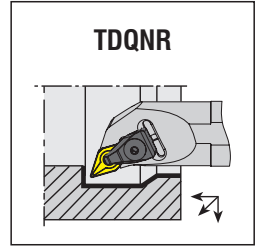
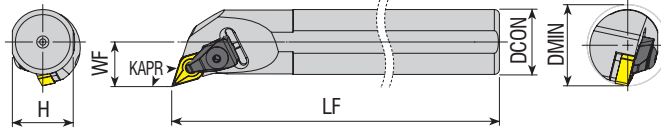

Takım Kodu Ordering Code Код для заказа	Stok Stock Наличие		Takım Ölçüleri (mm) Dimension (mm) Размеры (мм)					Kesici Uç Insert Пластина	Baskı Pabucu Wedge Clamp Прижим	Pabuç Vidası Clamp Screw Зажимной винт	Altlık Shim Опорная пластина	Altlık Vidası Shim Screw Винт опорной пластины	Segman Ring Кольцо	Pul Stamp Шайба	Anahtar Allen Key Ключ
	R	L	DCON	H	LF	WF	DMIN								
S25S TDQNR/L 11	●	●	25	23	250	17	≥32	DNM. 1104..	ATK-01	AKV-01-M5x22	AADN-2-0001	AAV-09-M5x9	-	ABPL-01	AAL-03-3
S32T TDQNR/L 11	●	●	32	30	300	22	≥40					AAV-04-M5x12			
S25S TDQNR/L 15	●	●	25	23	250	17	≥32	DNM. 1506..	ATK-02	AKV-30-M6x22	AADN-3-0001	AAV-13-M5x8	AS-01	ABPL-01	AAL-03-3
S32T TDQNR/L 15	●	●	32	30	300	22	≥40					AAV-02-M5x12			
S40U TDQNR/L 15	●	●	40	37.5	350	27	≥50								
S50V TDQNR/L 15	●	●	50	47	400	35	≥63								

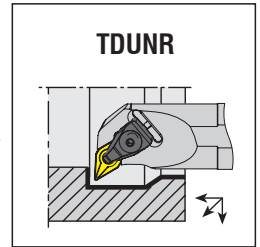
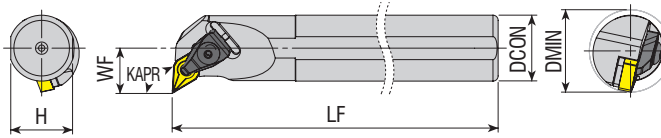

Takım Kodu Ordering Code Код для заказа	Stok Stock Наличие		Takım Ölçüleri (mm) Dimension (mm) Размеры (мм)					Kesici Uç Insert Пластина	Baskı Pabucu Wedge Clamp Прижим	Pabuç Vidası Clamp Screw Зажимной винт	Altlık Shim Опорная пластина	Altlık Vidası Shim Screw Винт опорной пластины	Segman Ring Кольцо	Pul Stamp Шайба	Anahtar Allen Key Ключ
	R	L	DCON	H	LF	WF	DMIN								
S25S TDUNR/L 11	●	●	25	23	250	17	≥32	DNM. 1104..	ATK-01	AKV-01-M5x22	AADN-2-0001	AAV-09-M5x9	-	ABPL-01	AAL-03-3
S32T TDUNR/L 11	●	●	32	30	300	22	≥40					AAV-04-M5x12			
S25S TDUNR/L 15	●	●	25	23	250	17	≥34	DNM. 1506..	ATK-02	AKV-30-M6x22	AADN-3-0001	AAV-13-M5x8	AS-01	ABPL-01	AAL-03-3
S32T TDUNR/L 15	●	●	32	30	300	22	≥40					AAV-02-M5x12			
S40U TDUNR/L 15	●	●	40	37.5	350	27	≥50								
S50V TDUNR/L 15	●	●	50	47	400	35	≥63								
new A40T TDUNR/L 15	●	●	40	37.5	300	27	≥50								

R: Sağ / Right / Правый L: Sol / Left / Левый
● Stokta / In Stock / В наличии ○ Stokta Yok / Non Stock Item / Нет в наличии

Sipariş Örneği/Ordering Example/Образец заказа
1 ad./pcs./шт. S25S TDQNR 11

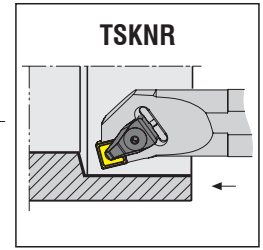
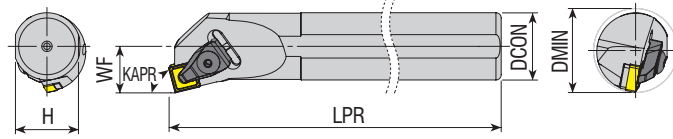

Takım Kodu Ordering Code Код для заказа	Stok Stock Наличие		Takım Ölçüleri (mm) Dimension (mm) Размеры (мм)					Kesici Uç Insert Пластина	Yedek Parçaları / Spare Parts / Запасные части						
	R	L	DCON	H	LPR	WF	DMIN		Baskı Pabucu Wedge Clamp Прижим	Pabuç Vidası Clamp Screw Зажимной винт	Altık Shim Отпорная пластина	Altık Vidası Shim Screw Винт опорной пластины	Segman Ring Кольцо	Pul Stamp Шайба	Anahtar Allen Key Ключ
S25S TSKNR/L 12	●	●	25	23	250	17	≥32	SNM. 1204..		AKV-30-M6x22	AASN -3-0004	AAV-13-M5x8	AS-01	ABPL-01	AAL-03-3
S32T TSKNR/L 12	●	●	32	30	300	22	≥40								
S40U TSKNR/L 12	●	●	40	37.5	350	27	≥50								

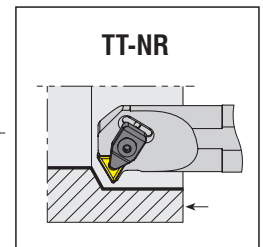
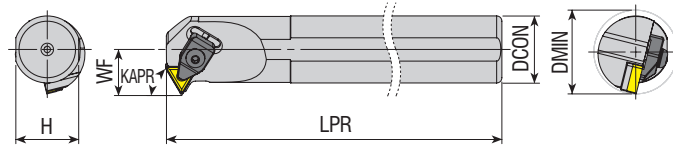

Takım Kodu Ordering Code Код для заказа	Stok Stock Наличие		Takım Ölçüleri (mm) Dimension (mm) Размеры (мм)					Kesici Uç Insert Пластина	Yedek Parçaları / Spare Parts / Запасные части						
	R	L	DCON	H	LPR	WF	DMIN		Baskı Pabucu Wedge Clamp Прижим	Pabuç Vidası Clamp Screw Зажимной винт	Altık Shim Отпорная пластина	Altık Vidası Shim Screw Винт опорной пластины	Yay Spring Пружина	Pul Stamp Шайба	Anahtar Allen Key Ключ
S25S TT-NR/L 16	●	●	25	23	250	17	≥32	TNM. 1604..		AKV-01-M5x22	AATN-2-0002	AAV-03-M5x12	-	ABPL-01	AAL-03-3
S32T TT-NR/L 16	●	●	32	30	300	22	≥40								

R: Sağ / Right / Правый L: Sol / Left / Левый
● Stokta / In Stock / В наличии ○ Stokta Yok / Non Stock Item / Нет в наличии

Sipariş Örneği/Ordering Example/Образец заказа
1 ad./pcs./шт. S25S TSKNR 12

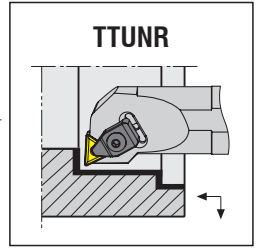
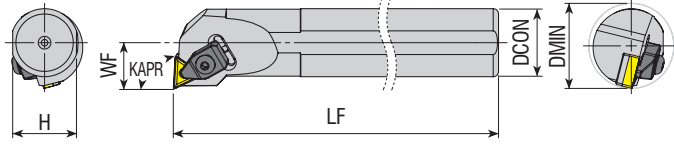
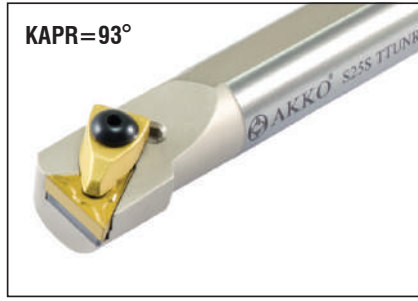

Takım Kodu Ordering Code Код для заказа	Stok Stock Наличие		Takım Ölçüleri (mm) Dimension (mm) Размеры (мм)					Kesici Uç Insert Пластина	Yedek Parçaları / Spare Parts / Запасные части						
	R	L	DCON	H	LF	WF	DMIN		Baskı Pabucu Wedge Clamp Прижим	Pabuç Vidası Clamp Screw Зажимной винт	Altlık Shim Опорная пластина	Altlık Vidası Shim Screw Винт опорной пластины	Segman Ring Кольцо	Pul Stamp Шайба	Anahtar Allen Key Ключ
S25S TTUNR/L 16	●	●	25	23	250	17	≥32	TNM. 1604..	ATK-01	AKV-01-M5x22	AATN-2-0002	AAV-03-M5x12	-	ABPL-01	AAL-03-3
S32T TTUNR/L 16	●	●	32	30	300	22	≥40								
S25S TTUNR/L 22	●	●	25	23	250	17	≥32	TNM. 2204..	ATK-02	AKV-30-M6x22	AATN-3-0015	AAV-02-M5x12	AS-01	ABPL-01	AAL-03-3
S32T TTUNR/L 22	●	●	32	30	300	22	≥40								
S40U TTUNR/L 22	●	●	40	37.5	350	27	≥50								
S50V TTUNR/L 22	●	●	50	47	400	35	≥63								

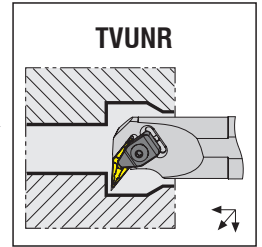
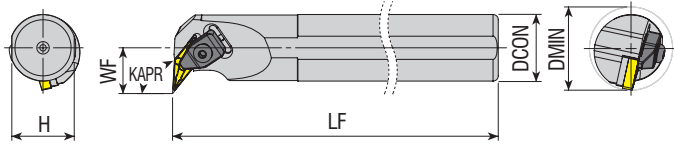
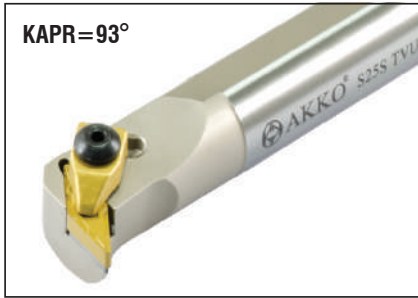

Takım Kodu Ordering Code Код для заказа	Stok Stock Наличие		Takım Ölçüleri (mm) Dimension (mm) Размеры (мм)					Kesici Uç Insert Пластина	Yedek Parçaları / Spare Parts / Запасные части						
	R	L	DCON	H	LF	WF	DMIN		Baskı Pabucu Wedge Clamp Прижим	Pabuç Vidası Clamp Screw Зажимной винт	Altlık Shim Опорная пластина	Altlık Vidası Shim Screw Винт опорной пластины	Yay Spring Пружина	Pul Stamp Шайба	Anahtar Allen Key Ключ
S25S TVUNR/L 16	●	●	25	23	250	20	≥36	VNM. 1604..	ATK-01	AKV-01-M5x22	AAVN-2-0002	AAV-04-M5x12	-	ABPL-01	AAL-03-3
S32T TVUNR/L 16	●	●	32	30	300	22	≥40								
S40U TVUNR/L 16	●	●	40	37.5	350	27	≥50								

R: Sağ / Right / Правый L: Sol / Left / Левый
● Stokta / In Stock / В наличии ○ Stokta Yok / Non Stock Item / Нет в наличии

Sipariş Örneği/Ordering Example/Образец заказа
1 ad./pcs./шт. S25S TTUNR 16

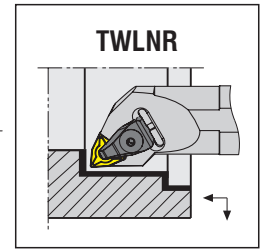
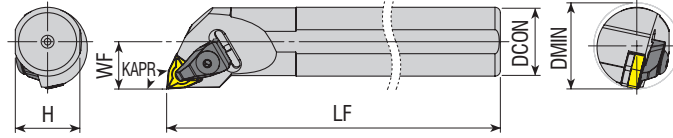

Takım Kodu Ordering Code Код для заказа	Stok Stock Наличие		Takım Ölçüleri (mm) Dimension (mm) Размеры (мм)					Yedek Parçaları / Spare Parts / Запасные части							
	R	L	DCON	H	LF	WF	DMIN	Kesici Uç Insert Пластина	Baskı Pabuçu Wedge Clamp Прижим	Pabuç Vidası Clamp Screw Зажимной винт	Altlık Shim Опорная пластина	Altlık Vidası Shim Screw Винт опорной пластины	Segman Ring Кольцо	Pul Stamp Шайба	Anahtar Allen Key Ключ
	●	○													
S25S TWLNR/L 06	●	●	25	23	250	17	≥32	WNM. 0604..	ATK-01	AKV-01-M5x22	AAWN-SW317	AAV-01-M3x10	-		
S32T TWLNR/L 06	●	●	32	30	300	22	≥40					AAV-13-M5x8			
S25S TWLNR/L 08	●	●	25	23	250	17	≥32	WNM. 0804..	ATK-02	AKV-30-M6x22	AAWN-3-0001	AAV-02-M5x12	AS-01	ABPL-01	AAL-03-3
S32T TWLNR/L 08	●	●	32	30	300	22	≥40								
S40U TWLNR/L 08	●	●	40	37.5	350	27	≥50								
S50V TWLNR/L 08	●	●	50	47	400	35	≥63								
A40T TWLNR/L 08	●	○	40	37.5	300	27	≥50								
A50U TWLNR/L 08	●	○	50	47	350	35	≥63								

C-SİSTEM DELİK TORNA KATERLERİ
C-SYSTEM BORING BARS
C-ТИП РАСТОЧНЫЕ ДЕРЖАВКИ

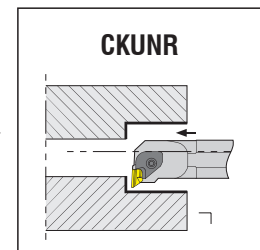
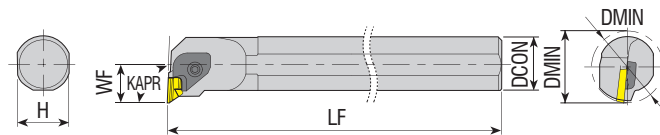

Takım Kodu Ordering Code Код для заказа	Stok Stock Наличие		Takım Ölçüleri (mm) Dimension (mm) Размеры (мм)					Yedek Parçaları / Spare Parts / Запасные части							
	R	L	DCON	H	LF	WF	DMIN	Kesici Uç Insert Пластина	Baskı Pabuçu Wedge Clamp Прижим	Pabuç Vidası Clamp Screw Зажимной винт	Altlık Shim Опорная пластина	Altlık Vidası Shim Screw Винт опорной пластины	Yay Spring Пружина	Pul Stamp Шайба	Anahtar Allen Key Ключ
	●	○													
S25S CKUNR/L 16	●	●	25	23	250	19	≥38	KNUX 1604..	ACK-01-R ACK-02-L	AKV-06-M6x20	AKS-16-R AKS-16-L	AAV-01-M3x10	AKY-02	ABPL-01	AAL-05-4
S32T CKUNR/L 16	●	●	32	30	300	22	≥40								
S40U CKUNR/L 16	●	●	40	37.5	350	27	≥50								
S50V CKUNR/L 16	●	●	50	47	400	35	≥63								

R: Sağ / Right / Правый L: Sol / Left / Левый
● Stokta / In Stock / В наличии ○ Stokta Yok / Non Stock Item / Нет в наличии

Sipariş Örneği/Ordering Example/Образец заказа
1 ad./pcs./шт. S25S TWLNR 06

➤ **C-SİSTEM DELİK TORNA KATERLERİ**
C-SYSTEM BORING BARS
C-ТИП РАСТОЧНЫЕ ДЕРЖАВКИ

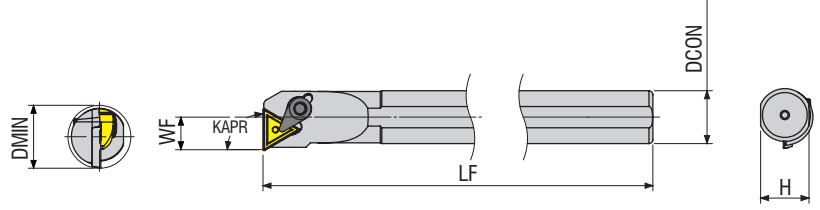

Takım Kodu
Ordering Code
Код для заказа

Stok Stock Наличие	Takım Ölçüleri (mm) Dimension (mm) Размеры (мм)						Kesici Uç Insert Пластина	Yedek Parçaları / Spare Parts / Запасные части							
	R	L	DCON	H	LF	WF		DMIN	Baskı Pabuçu Wedge Clamp Прижим	Pabuç Vidası Clamp Screw Зажимной винт	Altlık Shim Опорная пластина	Altlık Vidası Shim Screw Винт опорной пластины	Segman Ring Кольцо	Pul Stamp Шайба	Anahtar Allen Key Ключ
	●	○	16	14.7	200	11	22	TR.. 1603..	ACK-06	AKV-10-M6X14	-	-	-	-	AAL-05-4
S16R CTFPR/L 16															
S20S CTFPR/L 16															
S25T CTFPR/L 16	●	○	25	23	300	17	32								

R: Sağ / Right / Правый L: Sol / Left / Левый
● Stokta / In Stock / В наличии ○ Stokta Yok / Non Stock Item / Нет в наличии

Sipariş Örneği/Ordering Example/Образец заказа
1 ad./pcs./шт. S16R CTFPR 16



www.akkо.com.tr

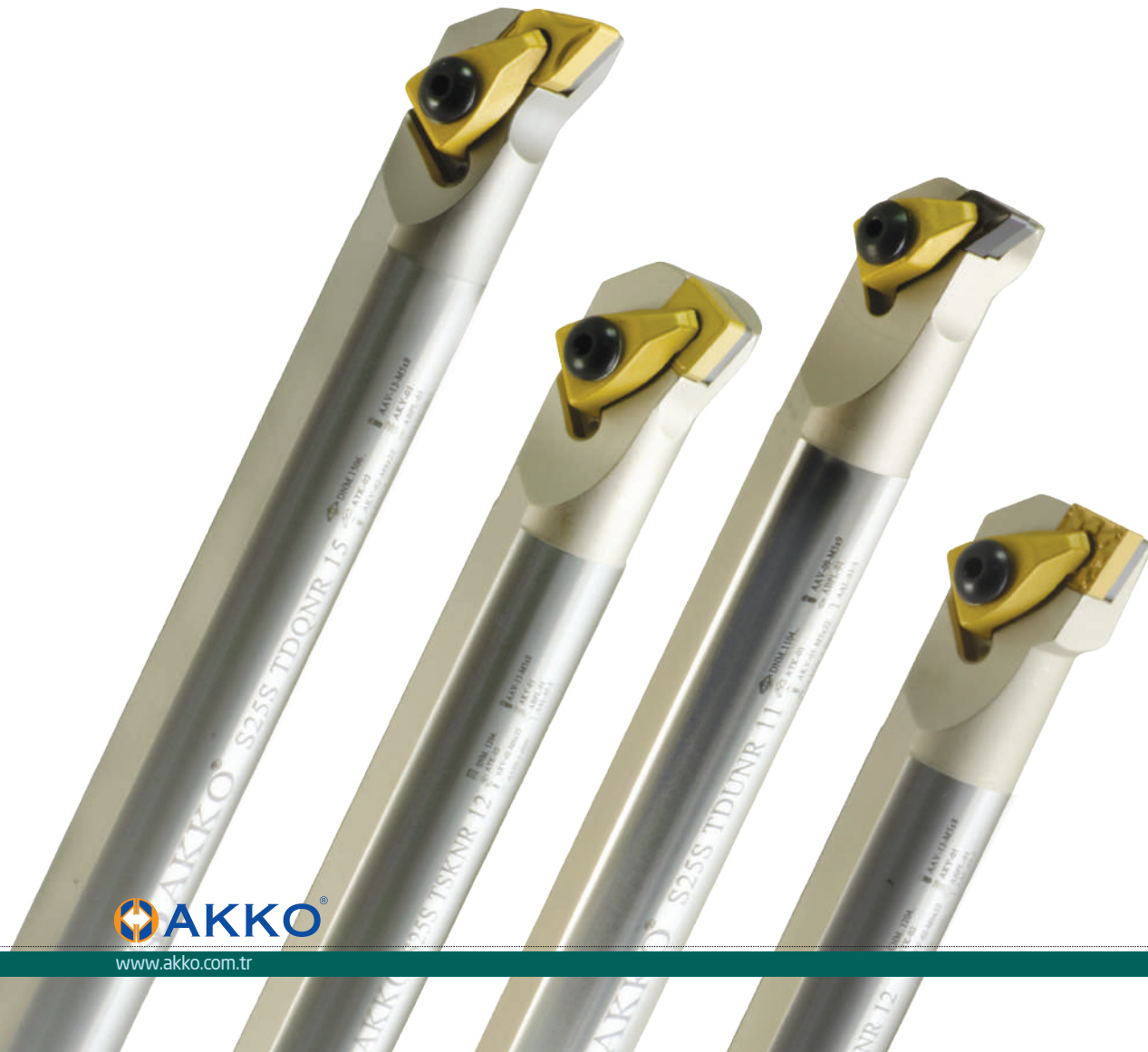



M-SİSTEM

M-SİSTEM DELİK TORNA KATERLERİ
M-SYSTEM BORING BARS
M-ТИП РАСТОЧНЫЕ ДЕРЖАВКИ

*konusulan
the spoken kalite...
quality...*



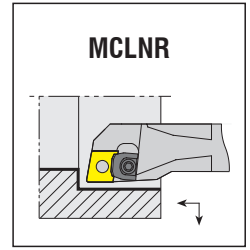
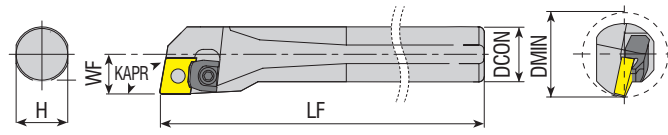

Takım Kodu
Ordering Code
Код для заказа

Stok Stock Наличие	Takım Ölçüleri (mm) Dimension (mm) Размеры (мм)						Kesici Uç Insert Пластина	Baskı Pabucu Wedge Clamp Прижим	Pabuç Vidası Clamp Screw Зажимной винт	Altlık Shim Опорная пластина	Pim Pin Штифт	Pul Stamp Шайба	Anahtar Allen Key Ключ	
	R	L	DCON	H	LF	WF								DMIN
	●	●	20	18.3	200	13	≥25	CNM. 1204..	AMK-07		-	APM-12		
	●	●	25	23	250	17	≥32		AMK-03	AKV-04-M5x17	AACN-3-0001	APM-13	-	AAL-03-3
	●	●	32	30	300	22	≥40					APM-04		

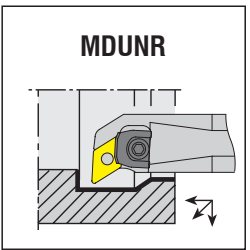
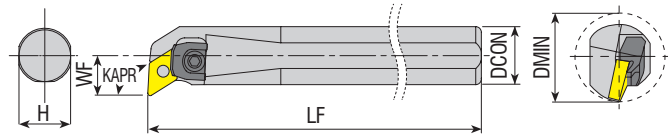

Takım Kodu
Ordering Code
Код для заказа

Stok Stock Наличие	Takım Ölçüleri (mm) Dimension (mm) Размеры (мм)						Kesici Uç Insert Пластина	Baskı Pabucu Wedge Clamp Прижим	Pabuç Vidası Clamp Screw Зажимной винт	Altlık Shim Опорная пластина	Pim Pin Штифт	Segman Ring Кольцо	Pul Stamp Шайба	Anahtar Allen Key Ключ
	R	L	DCON	H	LF	WF								
	●	●	20	18.3	200	13	≥25	DNM. 1104..		AKV-17-M5x15				
	●	●	25	23	250	17	≥32		AMK-03	AKV-04-M5x17	-	APM-03	-	-
	○	○	32	30	300	22	≥40							AAL-03-3
	●	●	25	23	250	17	≥32	DNM. 1506..		AKV-20-M6x19				
	●	●	32	30	300	22	≥40		AMK-04	AKV-30-M6x22	AADN-3-0001	APM-04	AS-01	ABPL-01
	●	●	40	37.5	350	27	≥50							
	●	●	50	47	400	35	≥63							

R: Sağ / Right / Правый L: Sol / Left / Левый
● Stokta / In Stock / В наличии ○ Stokta Yok / Non Stock Item / Нет в наличии

Sipariş Örneği/Ordering Example/Образец заказа
1 ad./pcs./шт. S20R MCLNR 12

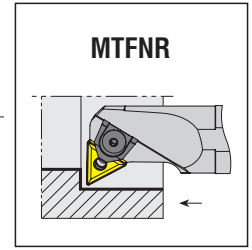
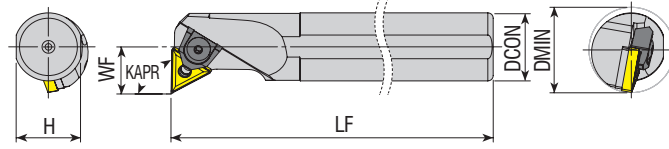

Takım Kodu Ordering Code Код для заказа	Stok Stock Наличие		Takım Ölçüleri (mm) Dimension (mm) Размеры (мм)				Kesici Uç Insert Пластина	Baskı Pabucu Wedge Clamp Прижим	Pabuç Vidası Clamp Screw Зажимной винт	Altık Shim Опорная пластина	Pim Pin Штифт	Segman Ring Кольцо	Pul Stamp Шайба	Anahtar Allen Key Ключ	
	R	L	DCON	H	LF	WF									DMIN
S20R MTFNR/L 16	●	●	20	18.3	200	14	≥25	TNM. 1604..	AMK-02	AKV-17-M5x15	-	APM-03	-	-	AAL-03-3
S25S MTFNR/L 16	●	●	25	23	250	17	≥32					APM-14			
S32T MTFNR/L 16	●	●	32	30	300	22	≥40				AATN-2-0002	APM-01	AS-01	ABPL-01	
S40U MTFNR/L 16	●	●	40	37.5	350	27	≥50		AMK-04	AKV-30-M6x22					
S32T MTFNR/L 22	●	●	32	30	300	22	≥40					APM-02			
S40U MTFNR/L 22	●	●	40	37.5	350	27	≥50		TNM. 2204..		AATN-3-0015				
S50V MTFNR/L 22	●	○	50	47	400	35	≥63								

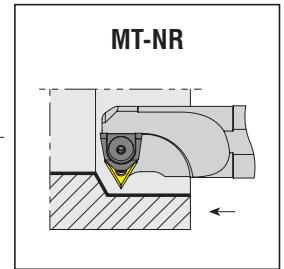
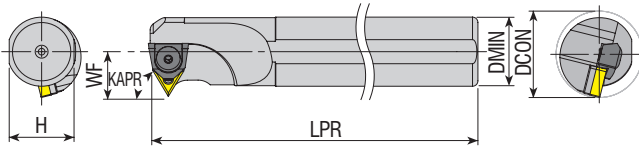

Takım Kodu Ordering Code Код для заказа	Stok Stock Наличие		Takım Ölçüleri (mm) Dimension (mm) Размеры (мм)				Kesici Uç Insert Пластина	Baskı Pabucu Wedge Clamp Прижим	Pabuç Vidası Clamp Screw Зажимной винт	Altık Shim Опорная пластина	Pim Pin Штифт	Segman Ring Кольцо	Pul Stamp Шайба	Anahtar Allen Key Ключ	
	R	L	DCON	H	LPR	WF									DMIN
S20R MT-NR/L 16	●	●	20	18.3	200	16	≥26	TNM. 1604..	AMK-02	AKV-04-M5x17	-	APM-03	-	-	AAL-03-3
S25S MT-NR/L 16	●	●	25	23	250	17	≥32					APM-14			
S32T MT-NR/L 16	●	●	32	30	300	22	≥40				AATN-2-0002	APM-01	AS-01	ABPL-01	
S40U MT-NR/L 16	●	●	40	37.5	350	27	≥50		AMK-04	AKV-30-M6x22					
S32T MT-NR/L 22	●	●	32	30	300	24	≥40					APM-02			
S40U MT-NR/L 22	●	●	40	37.5	350	27	≥50		TNM. 2204..		AATN-3-0015				
S50U MT-NR/L 22	●	●	50	47	350	35	≥63								

R: Sağ / Right / Правый L: Sol / Left / Левый
● Stokta / In Stock / В наличии ○ Stokta Yok / Non Stock Item / Нет в наличии

Sipariş Örneği/Ordering Example/Образец заказа
1 ad./pcs./шт. S20R MTFNR 16

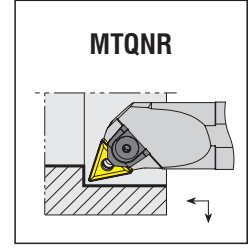
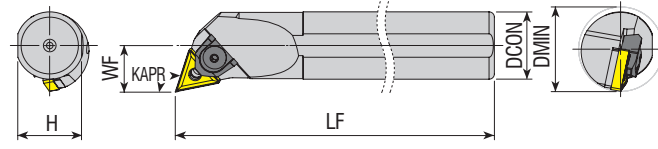

Takım Kodu Ordering Code Код для заказа	Stok Stock Наличие		Takım Ölçüleri (mm) Dimension (mm) Размеры (мм)					Kesici Uç Insert Пластина	Baskı Pabucu Wedge Clamp Прижим	Pabuç Vidası Clamp Screw Зажимной винт	Altlık Shim Опорная пластина	Pim Pin Штифт	Segman Ring Кольцо	Pul Stamp Шайба	Anahtar Allen Key Ключ					
	R	L	DCON	H	LF	WF	DMIN													
S20R MTQNR/L 16	●	●	20	18.3	200	13	≥25	TMM. 1604..	AMK-02	AKV-17-M5x15	-	APM-11	-	-	AAL-03-3					
S25S MTQNR/L 16	●	●	25	23	250	17	≥32		AMK-04	AKV-30-M6x22	AATN-2-0002	APM-14	AS-01	ABPL-01						
S32T MTQNR/L 16	●	●	32	30	300	22	≥40									AMK-08	AKV-30-M6x22	AATN-3-0015	APM-01	AS-01
S40U MTQNR/L 16	●	●	40	37.5	350	27	≥50		TMM. 2204..	AMK-08	AKV-30-M6x22	AATN-3-0015	APM-02	AS-01						
S32T MTQNR/L 22	●	●	32	30	300	22	≥40	AMK-08							AKV-30-M6x22	AATN-3-0015	APM-02	AS-01	ABPL-01	
S40U MTQNR/L 22	●	●	40	37.5	350	27	≥50													AMK-08
S50V MTQNR/L 22	●	●	50	47	400	35	≥63													

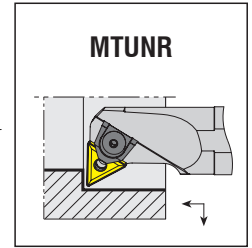
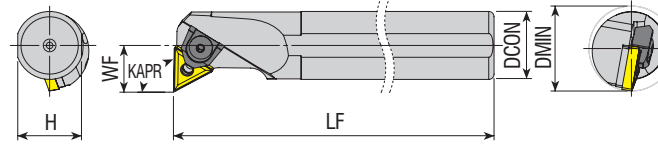

Takım Kodu Ordering Code Код для заказа	Stok Stock Наличие		Takım Ölçüleri (mm) Dimension (mm) Размеры (мм)					Kesici Uç Insert Пластина	Baskı Pabucu Wedge Clamp Прижим	Pabuç Vidası Clamp Screw Зажимной винт	Altlık Shim Опорная пластина	Pim Pin Штифт	Segman Ring Кольцо	Pul Stamp Шайба	Anahtar Allen Key Ключ					
	R	L	DCON	H	LF	WF	DMIN													
S20R MTUNR/L 16	●	●	20	18.3	200	13	≥25	TMM. 1604..	AMK-02	AKV-17-M5x15	-	APM-03	-	-	AAL-03-3					
S25S MTUNR/L 16	●	●	25	23	250	17	≥32		AMK-04	AKV-30-M6x22	AATN-2-0002	APM-14	AS-01	ABPL-01						
S32T MTUNR/L 16	●	●	32	30	300	22	≥40									AMK-08	AKV-30-M6x22	AATN-3-0015	APM-01	AS-01
S40U MTUNR/L 16	●	●	40	37.5	350	27	≥50		TMM. 2204..	AMK-08	AKV-30-M6x22	AATN-3-0015	APM-02	AS-01						
S50V MTUNR/L 16	●	●	50	47	400	35	≥63	AMK-08							AKV-30-M6x22	AATN-3-0015	APM-02	AS-01	ABPL-01	
S32T MTUNR/L 22	●	●	32	30	300	22	≥40													AMK-08
S40U MTUNR/L 22	●	●	40	37.5	350	27	≥50	AMK-08	AKV-30-M6x22	AATN-3-0015	APM-02	AS-01	ABPL-01							
S50V MTUNR/L 22	●	●	50	47	400	35	≥63													

R: Sağ / Right / Правый L: Sol / Left / Левый
● Stokta / In Stock / В наличии ○ Stokta Yok / Non Stock Item / Нет в наличии

Sipariş Örneği/Ordering Example/Образец заказа
1 ad./pcs./шт. S20R MTQNR 16

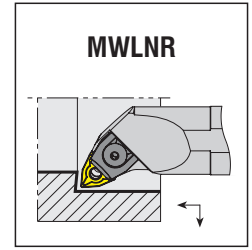
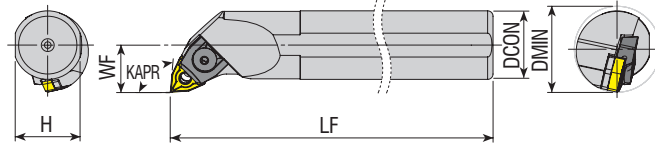

Takım Kodu
Ordering Code
Код для заказа

Stok Stock Наличие	Takım Ölçüleri (mm) Dimension (mm) Размеры (мм)						Kesici Uç Insert Пластина	Baskı Pabucu Wedge Clamp Прижим	Pabuç Vidası Clamp Screw Зажимной винт	Altık Shim Опорная пластина	Pim Pin Штифт	Segman Ring Кольцо	Pul Stamp Шайба	Anahtar Allen Key Ключ					
	R	L	DCON	H	LF	WF									DMIN				
	●	●	16	14.8	170	11	≥20	WNM. 0604..	AMK-01	AKV-17-M5x15	-	APM-09	-	-					
	●	●	20	18.3	200	13	≥25			AKV-04-M5x17		APM-10							
	●	●	25	23	250	17	≥32			AKV-27-M6x20		APM-08							
	●	●	25	23	250	17	≥32	WNM. 0804..	ACK-05	4015-M4x11	AAWN-3-0001	APM-04	-	-	-				
new	●	●	20	18.3	200	13	≥25					AMK-05				APM-02	AS-01	ABPL-01	AAL-03-3
	●	●	32	30	300	22	≥40												
	●	●	40	37.5	350	27	≥50												

R: Sağ / Right / Правый L: Sol / Left / Левый
● Stokta / In Stock / В наличии ○ Stokta Yok / Non Stock Item / Нет в наличии

Sipariş Örneği/Ordering Example/Образец заказа
1 ad./pcs./шт. S16P MWLNR 06





*konusulan
the spoken kalite...
quality...*

P-SİSTEM

P-SİSTEM DELİK TORNA KATERLERİ
P-SYSTEM BORING BARS
P-ТИП РАСТОЧНЫЕ ДЕРЖАВКИ



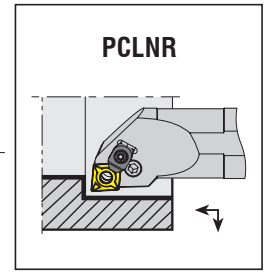
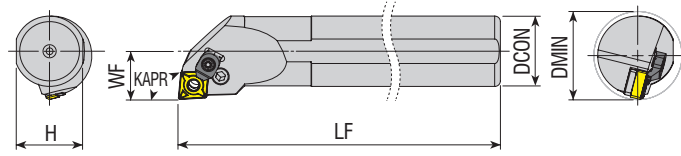

Takım Kodu
Ordering Code
Код для заказа

Takım Kodu Ordering Code Код для заказа	Stok Stock Наличие		Takım Ölçüleri (mm) Dimension (mm) Размеры (мм)					Kesici Uç Insert Пластина	Yedek Parçaları / Spare Parts / Запасные части						
	R	L	DCON	H	LF	WF	DMIN		Levyeye Lever Рычаг	Levyeye Vidası Lever Screw Винт рычага	Altılık Shim Опорная пластина	Altılık Yayı Shim Spring Втулка рычага	Baskı Pabuçu Wedge Clamp Прижим	Pabuç Vidası Clamp Screw Зажимный винт	Anahtar Allen Key Ключ
S16P PCLNR/L 09	●	●	16	14.8	170	11	≥20	CNM. 0903..	APL-07	ALV-07-M6x13	-	AAV-07	-	-	AAL-02-2.5
S20R PCLNR/L 09	●	●	20	18.3	200	13	≥25		APL-01	ALV-01-M6x14 ALV-02-M6x17	AACN-2-0002	AAV-01	-	-	AAL-02-2.5
S25S PCLNR/L 09	●	○	25	23	250	17	≥32			ALV-08-M8x16					
S25S PCLNR/L 12C	●	●	25	23	250	17	≥32	CNM. 1204..	APL-02	ALV-03-M8x19	AACN-3-0001	AAV-02	ACK-05	4015-M4x11	AAL-03-3
S32T PCLNR/L 12C	●	●	32	30	300	22	≥40								
S40U PCLNR/L 12C	●	●	40	37.5	350	27	≥50								
S50V PCLNR/L 12C	●	●	50	47	400	35	≥63								
S32T PCLNR/L 16C	●	●	32	30	300	22	≥40	CNM. 1606..	APL-04	ALV-04-M8x22	AACN-3-0002	AAV-03	ACK-09	AAV-05-M6x15	
S40U PCLNR/L 16C	●	●	40	37.5	350	27	≥50								
S50V PCLNR/L 16C	●	●	50	47	400	35	≥63								
S40U PCLNR/L 19C	●	●	40	37.5	350	27	≥50	CNM. 1906..	APL-05	ALV-05-M10x27	AACN-3-0003	AAV-04	ACK-09	AAV-05-M6x15	AAL-05-4
S50V PCLNR/L 19C	●	●	50	47	400	35	≥63								
A20P PCLNR/L 09	●	●	20	18.3	170	13	≥25		CNM. 0903..	APL-01	ALV-01-M6x17	AACN-2-0002	AAV-01	-	-
A25R PCLNR/L 12C	●	●	25	23	200	17	≥32	CNM. 1204..	APL-02	ALV-03-M8x19	AACN-3-0001	AAV-02	ACK-05	4015-M4x11	AAL-03-3
A25S PCLNR/L 12C	●	○	25	23	250	17	≥32								
A32S PCLNR/L 12C	●	●	32	30	250	22	≥40								
A32T PCLNR/L 12C	○	●	32	30	300	22	≥40	CNM. 1606..	APL-04	ALV-04-M8x22	AACN-3-0002	AAV-03	ACK-09	AAV-05-M6x15	
A40T PCLNR/L 12C	●	●	40	37.5	300	27	≥50								
A50U PCLNR/L 12C	●	●	50	47	350	35	≥63								
A32S PCLNR/L 16C	●	●	32	30	250	22	≥40	CNM. 1906..	APL-05	ALV-05-M10x27	AACN-3-0003	AAV-04	ACK-09	AAV-05-M6x15	AAL-05-4
A40T PCLNR/L 16C	●	●	40	37.5	300	27	≥50								
A50U PCLNR/L 16C	●	●	50	47	350	35	≥63								
A40T PCLNR/L 19C	●	●	40	37.5	300	27	≥50								
A50U PCLNR/L 19C	●	●	50	47	350	35	≥63								

R: Sağ / Right / Правый L: Sol / Left / Левый
● Stokta / In Stock / В наличии ○ Stokta Yok / Non Stock Item / Нет в наличии

Sipariş Örneği/Ordering Example/Образец заказа
1 ad./pcs./шт. S16P PCLNR 09

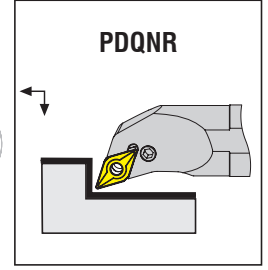
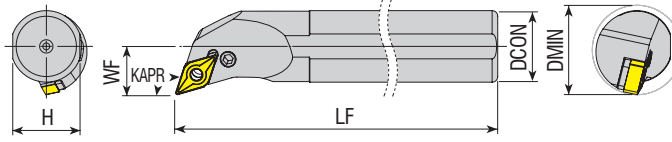

Takım Kodu Ordering Code Код для заказа	Stok Stock Наличие		Takım Ölçüleri (mm) Dimension (mm) Размеры (мм)					Kesici Uç Insert Пластина	Yedek Parçaları / Spare Parts / Запасные части						
	R	L	DCON	H	LF	WF	DMIN		Levyeye Lever Рычаг	Levyeye Vidası Lever Screw Винт рычага	Altılık Shim Опорная пластина	Altılık Yayı Shim Spring Втулка рычага	Baskı Pabucu Wedge Clamp Прижим	Pabuç Vidası Clamp Screw Зажимной винт	Anahtar Allen Key Ключ
	●	○													
S20R PDQNR/L 11	●	○	20	18.3	200	13	≥25	DNM. 1104..	APL-01	ALV-01-M6x14 ALV-02-M6x17	AADN-SD317	AAAY-01			AAL-02-2.5
S25S PDQNR/L 11	●	●	25	23	250	17	≥32								
S32T PDQNR/L 15	●	●	32	30	300	22	≥40	DNM. 1506..	APL-03	ALV-03-M8x19	AADN-3-0001	AAAY-02			AAL-03-3
S40U PDQNR/L 15	●	●	40	37.5	350	27	≥50								
S50V PDQNR/L 15	●	●	50	47	400	35	≥63	DNM. 1504..	APL-03	ALV-03-M8x19	AADN-2-0003	AAAY-02			AAL-03-3
S32T PDQNR/L 1504	●	●	32	30	300	22	≥40								
S40U PDQNR/L 1504	●	●	40	37.5	350	27	≥50	DNM. 1506..	APL-03	ALV-03-M8x19	AADN-3-0001	AAAY-02			AAL-03-3
S50V PDQNR/L 1504	●	●	50	47	400	35	≥63								
A20P PDQNR/L 11	●	●	20	18.3	170	13	≥25	DNM. 1104..	APL-01	ALV-01-M6x14 ALV-02-M6x17	AADN-SD317	AAAY-01			AAL-02-2.5
A25R PDQNR/L 11	●	●	25	23	200	17	≥32								
A32S PDQNR/L 15	●	●	32	30	250	22	≥40	DNM. 1506..	APL-03	ALV-03-M8x19	AADN-3-0001	AAAY-02			AAL-03-3
A40T PDQNR/L 15	●	●	40	37.5	300	27	≥50								
A50U PDQNR/L 15	●	●	50	47	350	35	≥63	DNM. 1504..	APL-03	ALV-03-M8x19	AADN-2-0003	AAAY-02			AAL-03-3
A32S PDQNR/L 1504	●	●	32	30	250	22	≥40								
A40T PDQNR/L 1504	●	●	40	37.5	300	27	≥50								

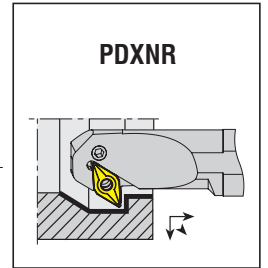
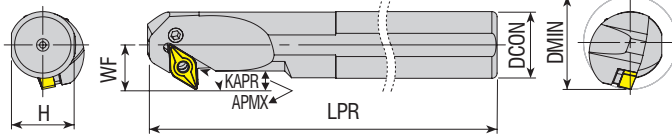

Takım Kodu Ordering Code Код для заказа	Stok Stock Наличие		Takım Ölçüleri (mm) Dimension (mm) Размеры (мм)						Kesici Uç Insert Пластина	Yedek Parçaları / Spare Parts / Запасные части						
	R	L	DCON	H	LPR	WF	APMX	DMIN		Levyeye Lever Рычаг	Levyeye Vidası Lever Screw Винт рычага	Altılık Shim Опорная пластина	Altılık Yayı Shim Spring Втулка рычага	Baskı Pabucu Wedge Clamp Прижим	Pabuç Vidası Clamp Screw Зажимной винт	Anahtar Allen Key Ключ
	●	○														
S32T PDXNR/L 15	●	●	32	30	300	22	12	≥45	DNM. 1506..	APL-03	ALV-08-M8x16 ALV-03-M8x19 ALV-08-M8x16 ALV-03-M8x19	AADN-3-0001	AAAY-02			AAL-03-3
S40U PDXNR/L 15	●	●	40	37.5	350	27	14	≥50								
S50V PDXNR/L 15	●	●	50	47	400	35	19	≥63								
A32S PDXNR/L 15	●	●	32	30	250	22	12	≥40								
A40T PDXNR/L 15	●	●	40	37.5	300	27	14	≥50								
A50U PDXNR/L 15	●	●	50	47	350	35	19	≥63								

R: Sağ / Right / Правый L: Sol / Left / Левый

● Stokta / In Stock / В наличии ○ Stokta Yok / Non Stock Item / Нет в наличии

Not: "APMX" ölçüleri R0.8'e göre verilmiştir. Note: Dimensions of "AMPX" are given according to R.08. Примечание: размеры должны быть R.08

Sipariş Örneği/Ordering Example/Образец заказа

1 ad./pcs./шт. S20R PDQNR 11

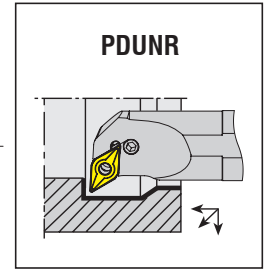
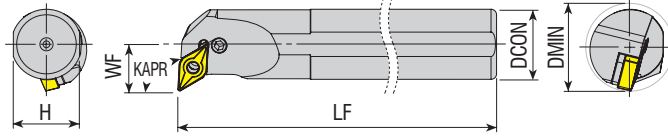
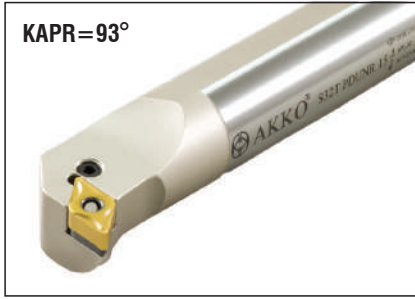

Takım Kodu Ordering Code Код для заказа	Stok Stock Наличие		Takım Ölçüleri (mm) Dimension (mm) Размеры (мм)				Kesici Uç Insert Пластина	Yedek Parçaları / Spare Parts / Запасные части							
	R	L	DCON	H	LF	WF		DMIN	Levyé Lever Рычаг	Levyé Vidası Lever Screw Винт рычага	Altılık Shim Отпорная пластина	Altılık Yayı Shim Spring Втулка рычага	Baskı Pabucu Wedge Clamp Прижим	Pabuç Vidası Clamp Screw Зажимной винт	Anahtar Allen Key Ключ
S20R PDUNR/L 11	●	●	20	18.3	200	13	≥25	DNM. 1104..	APL-01	ALV-01-M6x14 ALV-02-M6x17	AADN-SD317	AAY-01	-	-	AAL-02-2.5
S25S PDUNR/L 11	●	●	25	23	250	17	≥32								
S25S PDUNR/L 15	●	●	25	23	250	19	≥32								
S32T PDUNR/L 15	●	●	32	30	300	22	≥40	DNM. 1506..	APL-03	ALV-03-M8x19	AADN-3-0001	AAY-02	-	-	AAL-03-3
S40U PDUNR/L 15	●	●	40	37.5	350	27	≥50								
S50V PDUNR/L 15	●	●	50	47	400	35	≥63								
A20P PDUNR/L 11	●	●	20	18.3	170	13	≥25	DNM. 1104..	APL-01	ALV-01-M6x14 ALV-02-M6x17	AADN-SD317	AAY-01	-	-	AAL-02-2.5
A25R PDUNR/L 11	●	●	25	23	200	17	≥32								
new A25S PDUNR/L 11	●	○	25	23	250	17	≥32								
A32S PDUNR/L 11	●	●	32	30	250	22	≥40	DNM. 1506..	APL-03	ALV-03-M8x19	AADN-3-0001	AAY-02	-	-	AAL-03-3
A32S PDUNR/L 15	●	●	32	30	250	22	≥40								
A40T PDUNR/L 15	●	●	40	37.5	300	27	≥50								
A50U PDUNR/L 15	●	●	50	47	350	35	≥63								

R: Sağ / Right / Правый L: Sol / Left / Левый
● Stokta / In Stock / В наличии ○ Stokta Yok / Non Stock Item / Нет в наличии

Sipariş Örneği/Ordering Example/Образец заказа
1 ad./pcs./шт. S20R PDUNR 11



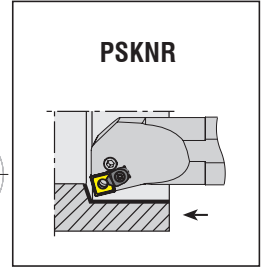
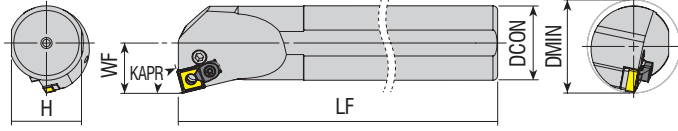

Takım Kodu Ordering Code Код для заказа	Stok Stock Наличие		Takım Ölçüleri (mm) Dimension (mm) Размеры (мм)				Kesici Uç Insert Пластина	Yedek Parçaları / Spare Parts / Запасные части							
	R	L	DCON	H	LF	WF		DMIN	Levyeye Lever Рычаг	Levyeye Vidası Lever Screw Винт рычага	Altılık Shim Опорная пластина	Altılık Yayını Shim Spring Втулка рычага	Baskı Pabuçunu Wedge Clamp Прижим	Pabuç Vidasını Clamp Screw Зажимной винт	Anahtar Allen Key Ключ
S25S PSKNR/L 12C	●	●	25	23	250	17	≥32	SNM. 1204..	APL-02	ALV-08-M8x16	AASN-3-0004	AAAY-02	ACK-05	4015-M4x11	AAL-03-3
S32T PSKNR/L 12C	●	●	32	30	300	22	≥40								
S40U PSKNR/L 12C	●	●	40	37.5	350	27	≥50								
S50V PSKNR/L 12C	●	●	50	47	400	35	≥63								
S32T PSKNR/L 15C	○	○	32	30	300	22	≥40	SNM. 1506..	APL-04	ALV-04-M8x22	AASN-3-0023	AAAY-03	ACK-09	AAV-05-M6x15	
S40U PSKNR/L 15C	○	○	40	37.5	350	27	≥50								
S50V PSKNR/L 15C	○	○	50	47	400	35	≥63								
A25R PSKNR/L 12C	●	●	25	23	200	17	≥32	SNM. 1204..	APL-02	ALV-08-M8x16	AASN-3-0004	AAAY-02	ACK-05	4015-M4x11	
A32S PSKNR/L 12C	●	●	32	30	250	22	≥40								
A40T PSKNR/L 12C	●	●	40	37.5	300	27	≥50								
A50U PSKNR/L 12C	○	○	50	47	350	35	≥63								
A32S PSKNR/L 15C	●	●	32	30	250	22	≥40	SNM. 1506..	APL-04	ALV-04-M8x22	AASN-3-0023	AAAY-03	ACK-09	AAV-05-M6x15	
A40T PSKNR/L 15C	●	●	40	37.5	300	27	≥50								
A50U PSKNR/L 15C	●	●	50	47	350	35	≥63								

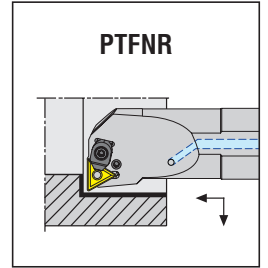
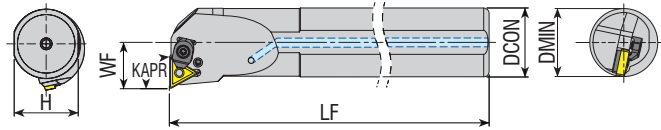

Takım Kodu Ordering Code Код для заказа	Stok Stock Наличие		Takım Ölçüleri (mm) Dimension (mm) Размеры (мм)				Kesici Uç Insert Пластина	Yedek Parçaları / Spare Parts / Запасные части							
	R	L	DCON	H	LF	WF		DMIN	Levyeye Lever Рычаг	Levyeye Vidası Lever Screw Винт рычага	Altılık Shim Опорная пластина	Altılık Yayını Shim Spring Втулка рычага	Baskı Pabuçunu Wedge Clamp Прижим	Pabuç Vidasını Clamp Screw Зажимной винт	Anahtar Allen Key Ключ
A25R PTFNR/L 16C	●	●	25	23	200	17	≥32	TNM. 1604..	APL-01	ALV-02-M6x17	AATN-3-0025	AAAY-01	ACK-05	4015-M4x11	AAL-03-3
A32S PTFNR/L 16C	●	●	32	30	250	22	≥40								

R: Sağ / Right / Правый L: Sol / Left / Левый
● Stokta / In Stock / В наличии ○ Stokta Yok / Non Stock Item / Нет в наличии

Sipariş Örneği/Ordering Example/Образец заказа
1 ad./pcs./шт. S25S PSKNR 12C

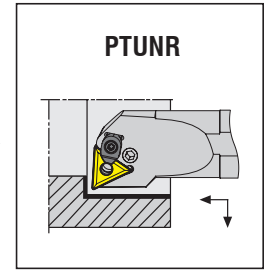
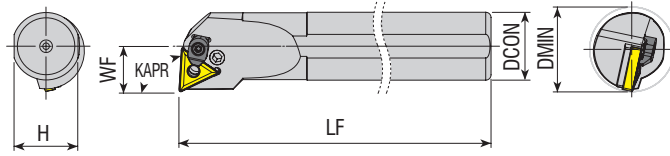

Takım Kodu Ordering Code Код для заказа	Stok Stock Наличие		Takım Ölçüleri (mm) Dimension (mm) Размеры (мм)					Kesici Uç Insert Пластина	Yedek Parçaları / Spare Parts / Запасные части						
	R	L	DCON	H	LF	WF	DMIN		Levyé Lever Рычаг	Levyé Vidası Lever Screw Винт рычага	Altık Shim Оторная пластина	Altık Yayı Shim Spring Втулка рычага	Baskı Pabuçu Wedge Clamp Прижим	Pabuç Vidası Clamp Screw Зажимной винт	Anahtar Allen Key Ключ
S16P PTUNR/L 16	●	●	16	14.8	170	11	≥20	TNM. 1604..	APL-08	ALV-07-M6x13	-	AAY-07	-	-	AAL-02-2.5
S20R PTUNR/L 16	●	●	20	18.3	200	13	≥25		APL-01	ALV-01-M6x14	AATN-3-0025	AAY-01	ACK-05	4015-M4x11	
S25S PTUNR/L 16C	●	●	25	23	250	17	≥32		APL-01	ALV-02-M6x17					
S32T PTUNR/L 16C	●	●	32	30	300	22	≥40		APL-01	ALV-02-M6x17					
S40U PTUNR/L 16C	●	●	40	37.5	350	27	≥50		APL-01	ALV-02-M6x17					
S32T PTUNR/L 22C	●	●	32	30	300	22	≥40	TNM. 2204..	APL-02	ALV-03-M8x19	AATN-3-0015	AAY-02	ACK-05	4015-M4x11	AAL-03-3
S40U PTUNR/L 22C	●	●	40	37.5	350	27	≥50		APL-02	ALV-03-M8x19	AATN-3-0015	AAY-02	ACK-05	4015-M4x11	AAL-03-3
S50V PTUNR/L 22C	●	●	50	47	400	35	≥63		APL-02	ALV-03-M8x19	AATN-3-0015	AAY-02	ACK-05	4015-M4x11	AAL-03-3
A16M PTUNR/L 16	●	●	16	14.8	150	11	≥20	TNM. 1604..	APL-08	ALV-07-M6x13	-	AAY-07	-	-	AAL-02-2.5
A20P PTUNR/L 16	●	●	20	18.3	170	13	≥25		APL-01	ALV-01-M6x14	AATN-3-0025	AAY-01	ACK-05	4015-M4x11	
A25R PTUNR/L 16C	●	●	25	23	200	17	≥32		APL-01	ALV-02-M6x17					
A32S PTUNR/L 16C	●	●	32	30	250	22	≥40		APL-01	ALV-02-M6x17					
A40T PTUNR/L 16C	●	●	40	37.5	300	27	≥50		APL-01	ALV-02-M6x17					
A32S PTUNR/L 22C	●	●	32	30	250	22	≥40	TNM. 2204..	APL-02	ALV-03-M8x19	AATN-3-0015	AAY-02	ACK-05	4015-M4x11	AAL-03-3
A40T PTUNR/L 22C	●	●	40	37.5	300	27	≥50		APL-02	ALV-03-M8x19	AATN-3-0015	AAY-02	ACK-05	4015-M4x11	AAL-03-3

R: Sağ / Right / Правый L: Sol / Left / Левый
● Stokta / In Stock / В наличии ○ Stokta Yok / Non Stock Item / Нет в наличии

Sipariş Örneği/Ordering Example/Образец заказа
1 ad./pcs./шт. S16P PTUNR 16



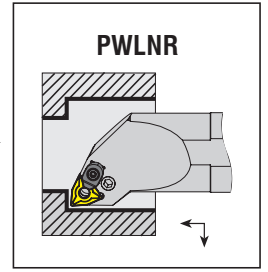
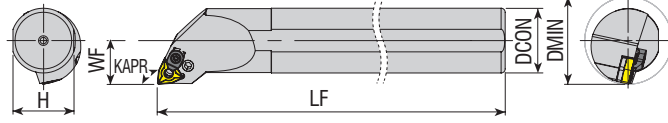

Yedek Parçaları / Spare Parts / Запасные части

Takım Kodu Ordering Code Код для заказа	Stok Stock Наличие		Takım Ölçüleri (mm) Dimension (mm) Размеры (мм)					Kesici Uç Insert Пластина	Levyer Lever Рычаг	Levyer Vidası Lever Screw Винт рычага	Altlık Shim Опорная пластина	Altlık Yayı Shim Spring Втулка рычага	Baskı Pabuçu Wedge Clamp Прижим	Pabuç Vidası Clamp Screw Зажимной винт	Anahtar Allen Key Ключ
	R	L	DCON	H	LF	WF	DMIN								
S20R PWNLR/L 06	●	●	20	18.3	200	13	≥25	WNM. 0604..	APL-01	ALV-01-M6x14	AAWN-SW317	AAY-01	-	-	AAL-02-2.5
S25S PWNLR/L 06	●	●	25	23	250	17	≥32								
S32T PWNLR/L 06	●	●	32	30	300	22	≥40								
S25S PWNLR/L 08C	●	●	25	23	250	17	≥32	WNM. 0804..	APL-02	ALV-03-M8x19	AAWN-3-0001	AAY-02	ACK-05	4015-M4x11	AAL-03-3
S32T PWNLR/L 08C	●	●	32	30	300	22	≥40								
S40U PWNLR/L 08C	●	●	40	37.5	350	27	≥50								
S50V PWNLR/L 08C	●	●	50	47	400	35	≥63	WNM. 0604..	APL-08	ALV-07-M6x13	-	AAY-07	-	-	AAL-02-2.5
A16M PWNLR/L 06	●	●	16	14.8	150	11	≥20								
A20P PWNLR/L 06	●	●	20	18.3	170	13	≥25								
A25R PWNLR/L 06	●	●	25	23	200	17	≥32	WNM. 0604..	APL-01	ALV-02-M6x17	AAWN-SW317	AAY-01	-	-	AAL-02-2.5
A32S PWNLR/L 06	●	●	32	30	250	22	≥40								
A40T PWNLR/L 06	●	○	40	37.5	300	27	≥50								
A25R PWNLR/L 08C	●	●	25	23	200	17	≥32	WNM. 0804..	APL-02	ALV-03-M8x19	AAWN-3-0001	AAY-02	ACK-05	4015-M4x11	AAL-03-3
A32S PWNLR/L 08C	●	●	32	30	250	22	≥40								
A40T PWNLR/L 08C	●	●	40	37.5	300	27	≥50								
A50U PWNLR/L 08C	●	●	50	47	350	35	≥63								

R: Sağ / Right / Правый L: Sol / Left / Левый
● Stokta / In Stock / В наличии ○ Stokta Yok / Non Stock Item / Нет в наличии

Sipariş Örneği/Ordering Example/Образец заказа
1 ad./pcs./шт. S20R PWNLR 06





*konusulan
the spoken kalite...
quality...*

S-SİSTEM

S-SİSTEM DELİK TORNA KATERLERİ
S-SYSTEM BORING BARS
S-ТИП РАСТОЧНЫЕ ДЕРЖАВКИ



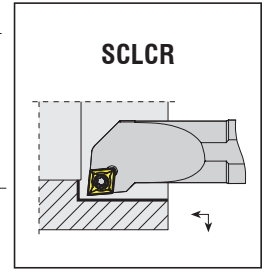
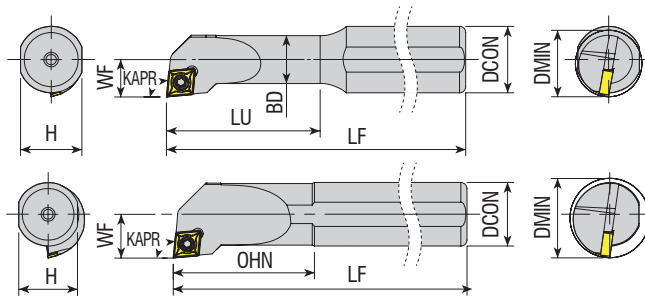

Takım Kodu Ordering Code Код для заказа	Stok Stock Наличие	Takım Ölçüleri (mm) Dimension (mm) Размеры (мм)								Kesici Uç Insert Пластина	Yedek Parçaları / Spare Parts / Запасные части					
		R	L	DCON	BD	H	LU=OHN	LF	WF		DMIN	Sıkma Vidası Screw Зажимной винт	Altlık Shim Опорная пластина	Altlık Vidası Shim Screw Винт опорной пластины	Tork Anahtar Torx Key Торх Ключ	
S0508H SCLCR/L 03	● ○			08	5	7.3	18	100	3	≥6	CC.T 030102	4006-M1.6x3.2				82-T06
S0608H SCLCR/L 06	● ●			08	6	7.3	25	100	4.5	≥8		4008-M2.5x4.5				
S08H SCLCR/L 06	● ●			08	8	7.3	20	100	06	≥11						
S10K SCLCR/L 06	● ●			10	10	09	25	125	07	≥13	CC.T 0602..	4008-M2.5x6	-	-	82-T08	
S12K SCLCR/L 06	● ●			12	12	11	25	125	09	≥16						
S1216P SCLCR/L 06	● ●			16	11.5	14.8	37	170	09	≥16						
S16P SCLCR/L 06	● ●			16	16	14.8	35	170	11	≥20	CC.T 09T3..	4015-M3.5x9	-	-	80-T15	
S12K SCLCR/L 09	● ●			12	12	11	30	125	09	≥16						
S1416P SCLCR/L 09	● ●			16	14	14.8	45	170	9.5	≥17						
S16P SCLCR/L 09	● ●			16	16	14.8	35	170	11	≥20	CC.T 09T3..	4015-M3.5x12	AACN-2-0001	AAV-08-M3.5x8	80-T20	
S1620R SCLCR/L 09	● ●			20	16	18.3	50	200	11	≥20						
S20R SCLCR/L 09	● ●			20	20	18.3	40	200	13	≥25						
S25S SCLCR/L 09	● ●			25	25	23	50	250	17	≥32	CC.T 1204..	4020-M4.5x12	AACN-2-0003	AAV-10-M4.5x8	80-T20	
S32T SCLCR/L 09	● ●			32	32	30	60	300	22	≥40						
S25S SCLCR/L 12	● ●			25	25	23	50	250	17	≥32						
S32T SCLCR/L 12	● ●			32	32	30	60	300	22	≥40	CC.T 1204..	1020-M4.5x16			80-T20	
S40U SCLCR/L 12	● ●			40	40	37.5	70	350	27	≥50						
A08H SCLCR/L 06	● ●			08	8	7.3	20	100	06	≥11			CC.T 0602..	4008-M2.5x6		-
A10H SCLCR/L 06	● ●			10	10	09	25	100	07	≥13						
A12H SCLCR/L 06	● ●			12	12	11	25	100	09	≥16						
A16M SCLCR/L 09	● ●			16	16	14.8	35	150	11	≥20	CC.T 09T3..	4015-M3.5x9	-	-	80-T15	
A20P SCLCR/L 09	● ●			20	20	18.3	40	170	13	≥25						
A25R SCLCR/L 09	● ●			25	25	23	50	200	17	≥32						
A32S SCLCR/L 09	● ●			32	32	30	60	250	22	≥40	CC.T 09T3..	4015-M3.5x12	AACN-2-0001	AAV-08-M3.5x8	80-T15	
A25R SCLCR/L 12	● ●			25	25	23	50	200	17	≥32						
											CC.T 1204..	4020-M4.5x12	AACN-2-0003	AAV-10-M4.5x8	80-T20	

R: Sağ / Right / Правый L: Sol / Left / Левый
● Stokta / In Stock / В наличии ○ Stokta Yok / Non Stock Item / Нет в наличии

Sipariş Örneği/Ordering Example/Образец заказа
1 ad./pcs./шт. S0508H SCLCR 03



KAPR=90°

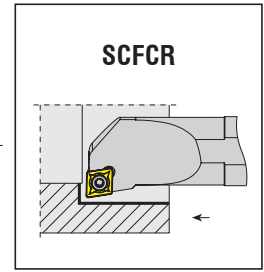
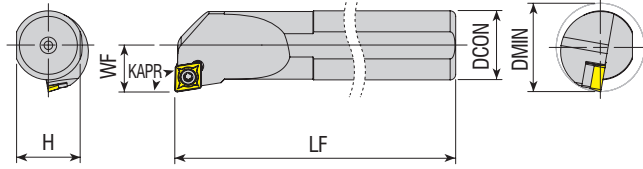

SCFCR

Yedek Parçaları / Spare Parts / Запасные части

Takım Kodu Ordering Code Код для заказа	Stok Stock Наличие		Takım Ölçüleri (mm) Dimension (mm) Размеры (мм)				Kesici Uç Insert Пластина	Yedek Parçaları / Spare Parts / Запасные части				
	R	L	DCON	H	LF	WF		DMIN	Sıkma Vidası Screw Зажимной винт	Altlık Shim Опорная пластина	Altlık Vidası Shim Screw Винт опорной пластины	Tork Anahtar Torx Key Торх Ключ
S08H SCFCR/L 06	●	●	08	7.3	100	06	≥11	CC.T 0602..	4008-M2.5x6	-	-	82-T08
S10K SCFCR/L 06	●	●	10	09	125	07	≥13		4015-M3.5x8	-	-	
S12K SCFCR/L 06	●	●	12	11	125	09	≥16		4015-M3.5x9	-	-	
S12K SCFCR/L 09	●	●	12	11	125	09	≥16	CC.T 09T3..	4015-M3.5x12	AACN-2-0001	AAV-08-M3.5x8	80-T15
S16P SCFCR/L 09	●	●	16	14.8	170	11	≥20		4020-M4.5x12	AACN-2-0003	AAV-10-M4.5x8	
S20R SCFCR/L 09	●	●	20	18.3	200	13	≥25		1020-M4.5x16	-	-	
S25S SCFCR/L 09	●	●	25	23	250	17	≥32	CC.T 1204..	4008-M2.5x6	-	-	82-T08
S25S SCFCR/L 12	●	○	25	23	250	17	≥32		4015-M3.5x14	AADN-2-0001	AAV-06-M3.5x11	
S32T SCFCR/L 12	○	○	32	30	300	22	≥40	CC.T 0602..	4008-M2.5x6	-	-	82-T08
S40U SCFCR/L 12	○	○	40	37.5	350	27	≥50		4015-M3.5x14	AADN-2-0001	AAV-06-M3.5x11	
A08H SCFCR/L 06	●	○	08	7.3	100	06	≥11	CC.T 0602..	4008-M2.5x6	-	-	82-T08



KAPR=62.5°

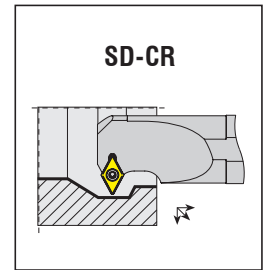
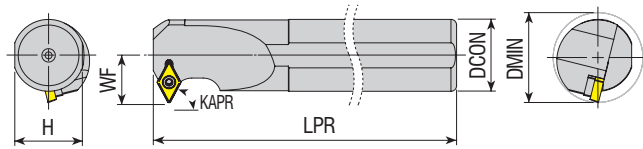

SD-CR

Yedek Parçaları / Spare Parts / Запасные части

Takım Kodu Ordering Code Код для заказа	Stok Stock Наличие		Takım Ölçüleri (mm) Dimension (mm) Размеры (мм)				Kesici Uç Insert Пластина	Yedek Parçaları / Spare Parts / Запасные части				
	R	L	DCON	H	LPR	WF		DMIN	Sıkma Vidası Screw Зажимной винт	Altlık Shim Опорная пластина	Altlık Vidası Shim Screw Винт опорной пластины	Tork Anahtar Torx Key Торх Ключ
S10K SD-CR/L 07	●	●	10	9	125	07	≥14	DC.T 0702..	4008-M2.5x6	-	-	82-T08
S12K SD-CR/L 07	●	●	12	11	125	09	≥16		4015-M3.5x11	-	-	
S16P SD-CR/L 07	●	●	16	14.8	170	11	≥20		4015-M3.5x14	AADN-2-0001	AAV-06-M3.5x11	
S20R SD-CR/L 07	●	○	20	18.3	200	13	≥25	DC.T 11T3..	4008-M2.5x6	-	-	80-T15
S16P SD-CR/L 11	●	●	16	14.8	170	14	≥22		4015-M3.5x11	-	-	
S20R SD-CR/L 11	●	●	20	18.3	200	15	≥25	4015-M3.5x14	AADN-2-0001	AAV-06-M3.5x11		
S25S SD-CR/L 11	●	●	25	23	250	18	≥32	DC.T 11T3..	4008-M2.5x6	-	-	80-T15
S32T SD-CR/L 11	●	●	32	30	300	22	≥40		4015-M3.5x14	AADN-2-0001	AAV-06-M3.5x11	
S40U SD-CR/L 11	●	●	40	37.5	350	27	≥50	CC.T 0602..	4008-M2.5x6	-	-	82-T08

R: Sağ / Right / Правый L: Sol / Left / Левый
● Stokta / In Stock / В наличии ○ Stokta Yok / Non Stock Item / Нет в наличии

Sipariş Örneği/Ordering Example/Образец заказа
1 ad./pcs./шт. S08H SCFCR 06

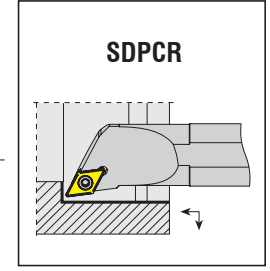
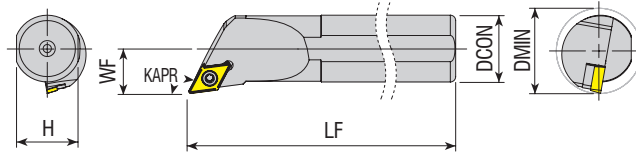

Takım Kodu
Ordering Code
Код для заказа

Stok Stock Наличие	Takım Ölçüleri (mm) Dimension (mm) Размеры (мм)						Kesici Uç Insert Пластина	Yedek Parçaları / Spare Parts / Запасные части				
	R	L	DCON	H	LF	WF		DMIN	Sikma Vidası Screw Зажимной винт	Altılık Shim Опорная пластина	Altılık Vidası Shim Screw Винт опорной пластины	Tork Anahtar Torx Key Торх Ключ
S10K SDPCR/L 07	●	●	10	09	125	07	≥13	DC.T 0702..	4008-M2.5x6	-	-	82-T08
S12K SDPCR/L 07	●	●	12	11	125	09	≥16					
S16P SDPCR/L 11	●	●	16	14.8	170	11	≥20	DC.T 11T3..	4015-M3.5x9	-	-	80-T15
S20R SDPCR/L 11	●	●	20	18.3	200	13	≥25		4015-M3.5x11	-	-	
S25S SDPCR/L 11	●	●	25	23	250	17	≥32		4015-M3.5x12	AADN-2-0001	AAV-08-M3.5x8	

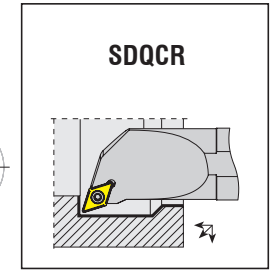
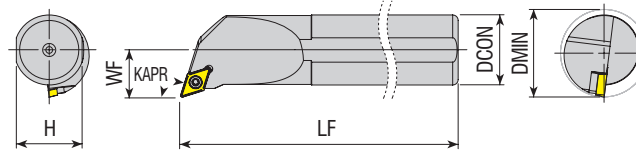

Takım Kodu
Ordering Code
Код для заказа

Stok Stock Наличие	Takım Ölçüleri (mm) Dimension (mm) Размеры (мм)						Kesici Uç Insert Пластина	Yedek Parçaları / Spare Parts / Запасные части				
	R	L	DCON	H	LF	WF		DMIN	Sikma Vidası Screw Зажимной винт	Altılık Shim Опорная пластина	Altılık Vidası Shim Screw Винт опорной пластины	Tork Anahtar Torx Key Торх Ключ
S10K SDQCR/L 07	●	●	10	09	125	07	≥13	DC.T 0702..	4008-M2.5x6	-	-	82-T08
S12K SDQCR/L 07	●	●	12	11	125	09	≥16					
S16P SDQCR/L 07	●	●	16	14.8	170	11	≥20	DC.T 11T3..	4015-M3.5x9	-	-	80-T15
S20R SDQCR/L 07	●	●	20	18.3	200	13	≥25		4015-M3.5x11	-	-	
S16P SDQCR/L 11	●	●	16	14.8	170	11	≥20		4015-M3.5x12	AADN-2-0001	AAV-08-M3.5x8	
S20R SDQCR/L 11	●	●	20	18.3	200	13	≥25		4015-M3.5x14	AADN-2-0001	AAV-06-M3.5x11	
S25S SDQCR/L 11	●	●	25	23	250	17	≥32					
S32T SDQCR/L 11	●	●	32	30	300	22	≥40	DC.T 0702..	4008-M2.5x6	-	-	82-T08
S40U SDQCR/L 11	●	●	40	37.5	350	27	≥50					
A10H SDQCR/L 07	●	●	10	09	100	07	≥13	DC.T 11T3..	4015-M3.5x9	-	-	80-T15
A12H SDQCR/L 07	●	●	12	11	100	09	≥16		4015-M3.5x11	-	-	
A16M SDQCR/L 07	●	●	16	14.8	150	11	≥20		4015-M3.5x12	AADN-2-0001	AAV-08-M3.5x8	
A20P SDQCR/L 07	●	●	20	18.3	170	13	≥25		4015-M3.5x14	AADN-2-0001	AAV-06-M3.5x11	
A16M SDQCR/L 11	●	●	16	14.8	150	11	≥20					
A20P SDQCR/L 11	●	●	20	18.3	170	13	≥25	DC.T 11T3..	4015-M3.5x11	-	-	80-T15
A25R SDQCR/L 11	●	●	25	23	200	17	≥32		4015-M3.5x12	AADN-2-0001	AAV-08-M3.5x8	
A32S SDQCR/L 11	●	●	32	30	250	22	≥40		4015-M3.5x14	AADN-2-0001	AAV-06-M3.5x11	

R: Sağ / Right / Правый L: Sol / Left / Левый
● Stokta / In Stock / В наличии ○ Stokta Yok / Non Stock Item / Нет в наличии

Sipariş Örneği/Ordering Example/Образец заказа
1 ad./pcs./шт. S10K SDPCR 07

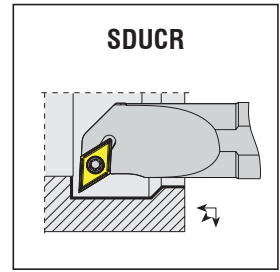
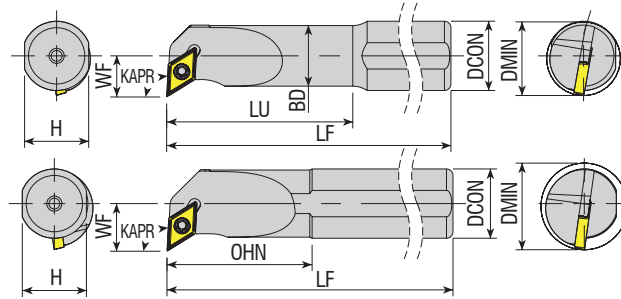

Takım Kodu Ordering Code Код для заказа	Stok Stock Наличие		Takım Ölçüleri (mm) Dimension (mm) Размеры (мм)							Kesici Uç Insert Пластина	Yedek Parçaları / Spare Parts / Запасные части				
	R	L	DCON	BD	H	LU=OHN	LF	WF	DMIN		Sıkma Vidası Screw Зажимной винт	Altlık Shim Опорная пластина	Altlık Vidası Shim Screw Винт опорной пластины	Tork Anahtar Torx Key Торх Ключ	
S0810K SDUCR/L 07	●	●	10	8	09	30	125	08	≥13	DC.T 0702..	4008-M2.5x6	-	-	82-T08	
S10K SDUCR/L 07	●	●	10	10	09	25	125	08	≥13						
S12K SDUCR/L 07	●	●	12	12	11	25	125	09	≥16						
S1216P SDUCR/L 07	●	●	16	11.5	14.8	37	170	09	≥16						
S1416P SDUCR/L 07	●	●	16	14	14.8	45	170	9.5	≥17						
S16P SDUCR/L 07	●	●	16	16	14.8	35	170	11	≥20						
S20R SDUCR/L 07	●	●	20	20	18.3	40	200	13	≥25	DC.T 11T3..	4015-M3.5x9	-	-	80-T15	
S1416P SDUCR/L 11	●	●	16	14	14.8	45	170	11	≥18						
S16P SDUCR/L 11	●	●	16	16	14.8	35	170	11	≥20						
S1620R SDUCR/L 11	●	●	20	16	18.3	50	200	11	≥20						
S20R SDUCR/L 11	●	●	20	20	18.3	40	200	13	≥25						
S25S SDUCR/L 11	●	●	25	25	23	50	250	17	≥32						
new S25T SDUCR/L 11	●	●	25	25	23	50	300	17	≥32						
S32T SDUCR/L 11	●	●	32	32	30	60	300	22	≥40						
S40U SDUCR/L 11	●	●	40	40	37.5	70	350	27	≥50						
S50V SDUCR/L 11	●	●	50	50	47	80	400	35	≥63						
A0810H SDUCR/L 07	●	●	10	8	09	30	100	08	≥13	DC.T 0702..	4008-M2.5x6	-	-	82-T08	
A10H SDUCR/L 07	●	●	10	10	09	25	100	08	≥13						
A12H SDUCR/L 07	●	●	12	12	11	25	100	09	≥16						
A16M SDUCR/L 07	●	●	16	16	14.8	35	150	11	≥20						
A20P SDUCR/L 07	●	●	20	20	18.3	40	170	13	≥25						
A16M SDUCR/L 11	●	●	16	16	14.8	35	150	11	≥20						
A20P SDUCR/L 11	●	●	20	20	18.3	40	170	13	≥25	DC.T 11T3..	4015-M3.5x9	-	-	80-T15	
A25R SDUCR/L 11	●	●	25	25	23	50	200	17	≥32						
new A25T SDUCR/L 11	●	○	25	25	23	50	300	17	≥32						
A32S SDUCR/L 11	●	●	32	32	30	60	250	22	≥40						
new A50U SDUCR/L 11	●	○	50	50	47	80	350	35	≥63						

R: Sağ / Right / Правый L: Sol / Left / Левый
● Stokta / In Stock / В наличии ○ Stokta Yok / Non Stock Item / Нет в наличии

Sipariş Örneği/Ordering Example/Образец заказа
1 ad./pcs./шт. S0810K SDUCR 07

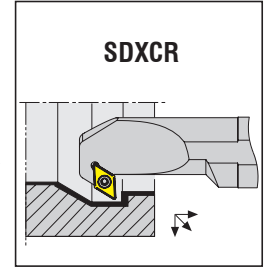
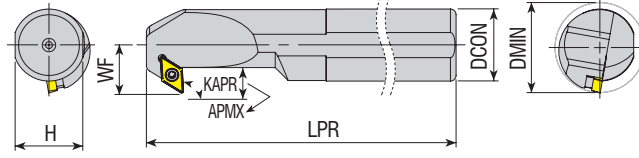

Takım Kodu Ordering Code Код для заказа	Stok Stock Наличие		Takım Ölçüleri (mm) Dimension (mm) Размеры (мм)					Kesici Uç Insert Пластина	Yedek Parçaları / Spare Parts / Запасные части						
	R	L	DCON	H	LPR	WF	APMX		DMIN	Sıkma Vidası Screw Зажимной винт	Altlık Shim Опорная пластина	Altlık Vidası Shim Screw Винт опорной пластины	Tork Anahtar Torx Key Торх Ключ		
S12K SDXCR/L 07	●	●	12	11	125	09	4.5	≥16	DC.T 0702..	4008-M2.5x6	-	-	82-T08		
S16P SDXCR/L 07	●	●	16	14.8	170	11	6.5	≥20		DC.T 11T3..	4015-M3.5x9	-		-	
S20R SDXCR/L 07	●	●	20	18.3	200	13	6.5	≥25			DC.T 11T3..	4015-M3.5x14		AADN-2-0001	AAV-08-M3.5x8
S16P SDXCR/L 11	●	●	16	14.8	170	11	6.5	≥20	DC.T 11T3..			4015-M3.5x11	-	-	
S20R SDXCR/L 11	●	●	20	18.3	200	14	7.5	≥25		DC.T 11T3..		4015-M3.5x14	AADN-2-0001	AAV-06-M3.5x11	80-T15
S25S SDXCR/L 11	●	●	25	23	250	17	9	≥32			DC.T 11T3..	4015-M3.5x14	AADN-2-0001	AAV-08-M3.5x8	
S32T SDXCR/L 11	●	●	32	30	300	22	12.5	≥40	DC.T 11T3..			4015-M3.5x14	AADN-2-0001	AAV-06-M3.5x11	
S40U SDXCR/L 11	●	●	40	37.5	350	27	14.5	≥50		DC.T 11T3..		4015-M3.5x14	AADN-2-0001	AAV-06-M3.5x11	
A12H SDXCR/L 07	●	●	12	11	100	09	4.5	≥16			DC.T 0702..	4008-M2.5x6	-	-	82-T08
A16M SDXCR/L 07	●	●	16	14.8	150	11	6.5	≥20	DC.T 11T3..			4015-M3.5x11	-	-	
A20P SDXCR/L 07	●	●	20	18.3	170	13	6.5	≥25		DC.T 11T3..		4015-M3.5x14	AADN-2-0001	AAV-08-M3.5x8	
A16M SDXCR/L 11	●	●	16	14.8	150	11	7.5	≥20			DC.T 11T3..	4015-M3.5x14	AADN-2-0001	AAV-06-M3.5x11	
A20P SDXCR/L 11	●	●	20	18.3	170	14	7.5	≥25	DC.T 11T3..			4015-M3.5x14	AADN-2-0001	AAV-06-M3.5x11	
A25R SDXCR/L 11	●	●	25	23	200	17	9	≥32		DC.T 11T3..		4015-M3.5x14	AADN-2-0001	AAV-08-M3.5x8	80-T15
A32S SDXCR/L 11	●	●	32	30	250	22	12.5	≥40			DC.T 11T3..	4015-M3.5x14	AADN-2-0001	AAV-06-M3.5x11	

R: Sağ / Right / Правый L: Sol / Left / Левый
● Stokta / In Stock / В наличии ○ Stokta Yok / Non Stock Item / Нет в наличии
Not: "APMX" ölçüleri R0.4'e göre verilmiştir.
Note: Dimensions of "APMX" are given according to R.0,4
Примечание: размеры должны быть R.04

Sipariş Örneği/Ordering Example/Образец заказа
1 ad./pcs./шт. S12K SDXCR 07

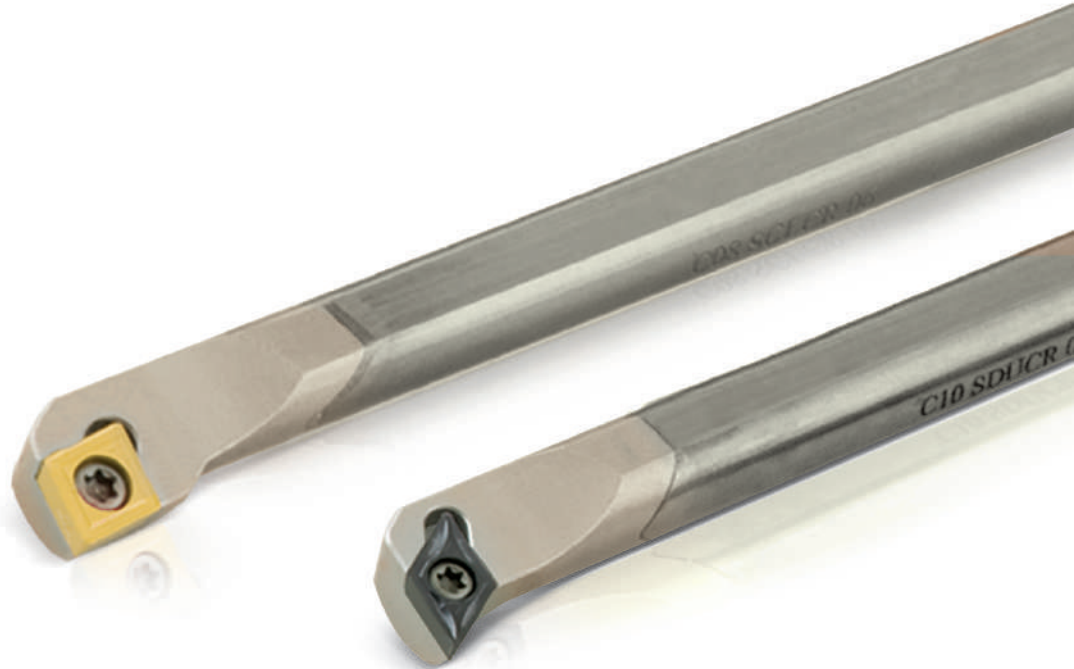

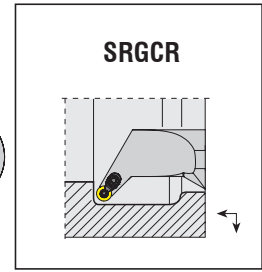
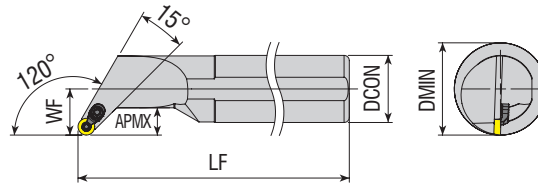
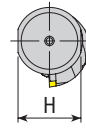

Takım Kodu
Ordering Code
Код для заказа

Stok Stock Наличие	Takım Ölçüleri (mm) Dimension (mm) Размеры (мм)							Kesici Uç Insert Пластина	Yedek Parçaları / Spare Parts / Запасные части						
	R	L	DCON	H	LF	WF	APMX		DMIN	Sıkma Vidası Screw Зажимной винт	Altık Shim Опорная пластина	Altık Vidası Shim Screw Винт опорной пластины	Baskı Pabuçu Shim Screw Spannpratze	Pabuç Vidası Shim Screw Зажимной винт	Anahtar Allen Key Ключ
	●	○	16	14.8	170	11	7	≥22	RCM. 0803..	3008-M3x8	-	-	ACK-15	4015-M3.5x11	82-T08
S16P SRGCR/L 08	●	○	20	18.3	200	13	7	≥26							
S20R SRGCR/L 08	●	●	25	23	250	17	9.5	≥34							
S25S SRGCR/L 08C	●	○	32	30	300	22	13	≥44							
S40U SRGCR/L 08C	●	○	40	37.5	350	27	15	≥54							
A16M SRGCR/L 08	●	●	16	14.8	150	11	7	≥22							
A20P SRGCR/L 08	●	●	20	18.3	170	13	7	≥26							
A25R SRGCR/L 08C	●	●	25	23	200	17	9.5	≥34							
A32S SRGCR/L 08C	●	●	32	30	250	22	13	≥44							
A40T SRGCR/L 08C	●	●	40	37.5	300	27	15	≥54							



KAPR=45°

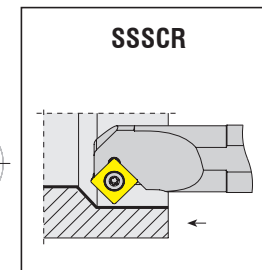
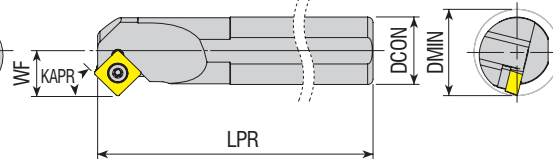
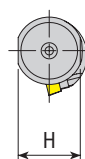

Takım Kodu
Ordering Code
Код для заказа

Stok Stock Наличие	Takım Ölçüleri (mm) Dimension (mm) Размеры (мм)							Kesici Uç Insert Пластина	Yedek Parçaları / Spare Parts / Запасные части			
	R	L	DCON	H	LPR	WF	DMIN		Sıkma Vidası Screw Зажимной винт	Altık Shim Опорная пластина	Altık Vidası Shim Screw Винт опорной пластины	Tork Anahtar Torx Key Торх Ключ
	●	●	16	14.8	170	11	≥20	SC.T 09T3..	4015-M3.5x9	-	-	80-T15
S16P SSSCR/L 09	●	●	20	18.3	200	13	≥25					
S20R SSSCR/L 09	●	●	25	23	250	17	≥32					
S25S SSSCR/L 09	●	●	25	23	250	17	≥32	SC.T 1204..	4015-M3.5x11	AASN-2-0001	AAV-08-M3.5x8	80-T20
S25S SSSCR/L 12	●	●	32	30	300	22	≥40					
S32T SSSCR/L 12	●	○	40	37.5	350	27	≥50					
S40U SSSCR/L 12	●	○	40	37.5	350	27	≥50	1020-M4.5x16	AASN-2-0004	AAV-10-M4.5x8	AAV-07-M4.5x8	

R: Sağ / Right / Правый L: Sol / Left / Левый
● Stokta / In Stock / В наличии ○ Stokta Yok / Non Stock Item / Нет в наличии

Sipariş Örneği/Ordering Example/Образец заказа
1 ad./pcs./шт. S16P SRGCR 08

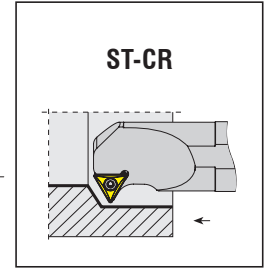
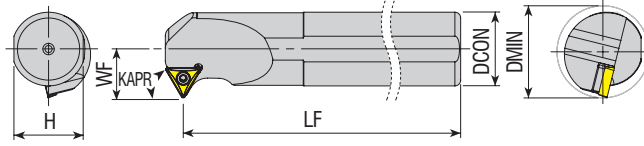

Takım Kodu Ordering Code Код для заказа	Stok Stock Наличие		Takım Ölçüleri (mm) Dimension (mm) Размеры (мм)					Kesici Uç Insert Пластина	Yedek Parçaları / Spare Parts / Запасные части			
	R	L	DCON	H	LF	WF	DMIN		Sıkma Vidası Screw Зажимной винт	Altlık Shim Опорная пластина	Altlık Vidası Shim Screw Винт опорной пластины	Tork Anahtar Torx Key Торх Ключ
S12K ST-CR/L 11	●	●	12	11	125	09	≥17	TC.T 1102..	4008-M2.5x6	-	-	82-T08
S16P ST-CR/L 11	●	○	16	14.8	170	11	≥20					
S20R ST-CR/L 11	●	○	20	18.3	200	13	≥25					
S16P ST-CR/L 16	●	●	16	14.8	170	11	≥20	TC.T 16T3..	4015-M3.5x9 4015-M3.5x11	-	-	80-T15
S20R ST-CR/L 16	●	●	20	18.3	200	13	≥25					
S25S ST-CR/L 16	●	●	25	23	250	17	≥32					
S32T ST-CR/L 16	●	●	32	30	300	22	≥40	4015-M3.5x14	AATN-2-0001	AAV-08-M3.5x8 AAV-06-M3.5x11	80-T15	
S40U ST-CR/L 16	●	●	40	37.5	350	27	≥50					

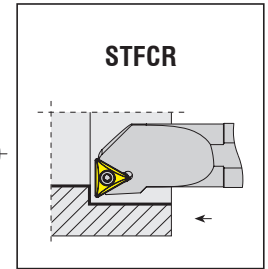
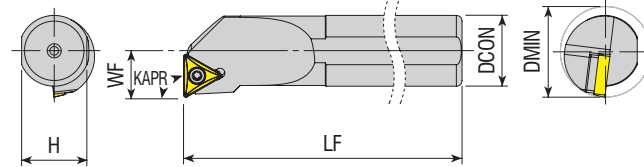

Takım Kodu Ordering Code Код для заказа	Stok Stock Наличие		Takım Ölçüleri (mm) Dimension (mm) Размеры (мм)					Kesici Uç Insert Пластина	Yedek Parçaları / Spare Parts / Запасные части			
	R	L	DCON	H	LF	WF	DMIN		Sıkma Vidası Screw Зажимной винт	Altlık Shim Опорная пластина	Altlık Vidası Shim Screw Винт опорной пластины	Tork Anahtar Torx Key Торх Ключ
S0610F STFCL/L 06	●	●	10	09	80	4.5	≥08	TC.T 06T1..	3006-M2x4	-	-	82-T06
S08H STFCL/L 06	●	●	08	7.3	100	06	≥11					
S10K STFCL/L 09	●	●	10	09	125	07	≥13	TC.T 0902..	3007-M2.2x4.6	-	-	82-T07
S12K STFCL/L 09	●	●	12	11	125	09	≥17					
S12K STFCL/L 11	●	●	12	11	125	09	≥17	TC.T 1102..	4008-M2.5x6	-	-	82-T08
S16P STFCL/L 11	●	●	16	14.8	170	11	≥20					
S20R STFCL/L 11	●	●	20	18.3	200	13	≥25					
S16P STFCL/L 16	●	●	16	14.8	170	11	≥20	TC.T 16T3..	4015-M3.5x9 4015-M3.5x11	-	-	80-T15
S20R STFCL/L 16	●	●	20	18.3	200	13	≥25					
S25S STFCL/L 16	●	●	25	23	250	17	≥32					
S32T STFCL/L 16	●	●	32	30	300	22	≥40	4015-M3.5x14	AATN-2-0001	AAV-08-M3.5x8 AAV-06-M3.5x11	80-T15	
S40U STFCL/L 16	●	○	40	37.5	350	27	≥50					
A10H STFCL/L 11	●	●	10	09	100	07	≥13	TC.T 1102..	4008-M2.5x6	-	-	82-T08
A12H STFCL/L 11	●	●	12	11	100	09	≥17					
A16M STFCL/L 11	●	●	16	14.8	150	11	≥20					

R: Sağ / Right / Правый L: Sol / Left / Левый
● Stokta / In Stock / В наличии ○ Stokta Yok / Non Stock Item / Нет в наличии

Sipariş Örneği/Ordering Example/Образец заказа
1 ad./pcs./шт. S12K ST-CR 11

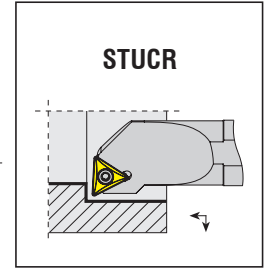
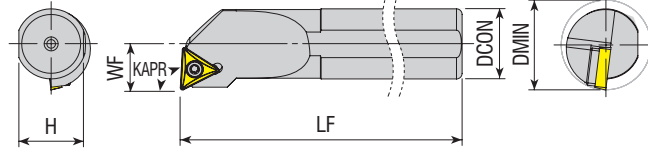

Takım Kodu Ordering Code Код для заказа	Stok Stock Наличие		Takım Ölçüleri (mm) Dimension (mm) Размеры (мм)				Kesici Uç Insert Пластина	Yedek Parçaları / Spare Parts / Запасные части				
	R	L	DCON	H	LF	WF		DMIN	Sıkma Vidası Screw Зажимной винт	Altık Shim Опорная пластина	Altık Vidası Shim Screw Винт опорной пластины	Tork Anahtar Torx Key Торх Ключ
S10K STUCR/L 09	●	●	10	09	125	07	≥13	TC.T 0902..	3007-M2.2x4.6			82-T07
S12K STUCR/L 09	●	●	12	11	125	09	≥16					
S12K STUCR/L 11	●	●	12	11	125	09	≥17	TC.T 1102..	4008-M2.5x6	-	-	82-T08
S16P STUCR/L 11	●	●	16	14.8	170	11	≥20					
S20R STUCR/L 11	●	●	20	18.3	200	13	≥25	TC.T 16T3..	4015-M3.5x9 4015-M3.5x11	-	-	80-T15
S16P STUCR/L 16	●	●	16	14.8	170	11	≥20					
S20R STUCR/L 16	●	●	20	18.3	200	13	≥25					
S25S STUCR/L 16	●	●	25	23	250	17	≥32					
S32T STUCR/L 16	●	●	32	30	300	22	≥40	4015-M3.5x14	AATN-2-0001	AAV-06-M3.5x11	80-T15	
S40U STUCR/L 16	●	●	40	37.5	350	27	≥50					
A10H STUCR/L 09	●	●	10	09	100	07	≥13	TC.T 0902..	3007-M2.2x4.6			82-T07
A12H STUCR/L 09	●	●	12	11	100	09	≥16					
A12H STUCR/L 11	●	●	12	11	100	09	≥16	TC.T 1102..	4008-M2.5x6	-	-	82-T08
A16M STUCR/L 11	●	●	16	14.8	150	11	≥20					
A20P STUCR/L 11	●	●	20	18.3	170	13	≥25	TC.T 16T3..	4015-M3.5x9 4015-M3.5x11	-	-	80-T15
A16M STUCR/L 16	●	●	16	14.8	150	11	≥20					
A20P STUCR/L 16	●	●	20	18.3	170	13	≥25					
A25R STUCR/L 16	●	●	25	23	200	17	≥32					
A32S STUCR/L 16	●	●	32	30	250	22	≥40	4015-M3.5x14	AATN-2-0001	AAV-08-M3.5x8 AAV-06-M3.5x11		

R: Sağ / Right / Правый L: Sol / Left / Левый
● Stokta / In Stock / В наличии ○ Stokta Yok / Non Stock Item / Нет в наличии

Sipariş Örneği/Ordering Example/Образец заказа
1 ad./pcs./шт. S10K STUCR 09



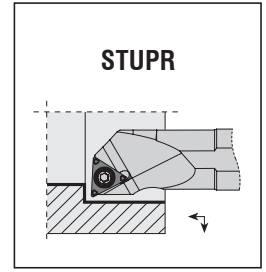
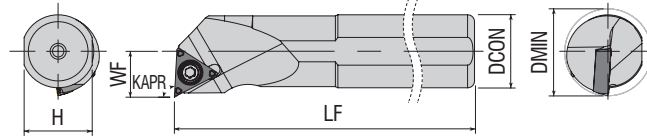

Takım Kodu Ordering Code Код для заказа	Stok Stock Наличие		Takım Ölçüleri (mm) Dimension (mm) Размеры (мм)				Kesici Uç Insert Пластина	Yedek Parçaları / Spare Parts / Запасные части				
	R	L	DCON	H	LF	WF		DMIN	Sıkma Vidası Screw Зажимной винт	Altık Shim Опорная пластина	Altık Vidası Shim Screw Винт опорной пластины	Tork Anahtar Torx Key Торх Ключ
S08H STUPR/L 0802	●	○	08	7.3	100	05	≥10	TP. 0802..	3006-M2x4			82-T06
S10K STUPR/L 1103	●	○	10	09	125	06	≥12					
S12K STUPR/L 1103	●	○	12	11	125	08	≥16	TP. 1103..	4010-M3x6	-	-	82-T10
S12M STUPR/L 1103	●	○	12	11	150	08	≥16					
S16P STUPR/L 1103	●	○	16	14.8	170	10	≥20					
S16R STUPR/L 1103	●	○	16	14.8	200	10	≥20					
A20R STUPR/L 1103	●	○	20	18.3	200	13	≥25		4010-M3x8			

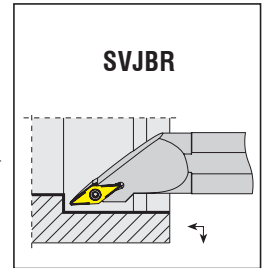
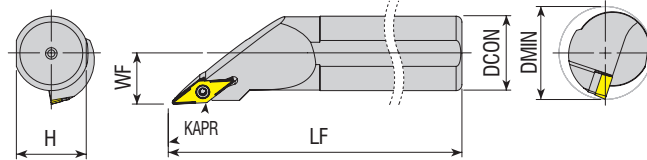

Takım Kodu Ordering Code Код для заказа	Stok Stock Наличие		Takım Ölçüleri (mm) Dimension (mm) Размеры (мм)				Kesici Uç Insert Пластина	Yedek Parçaları / Spare Parts / Запасные части				
	R	L	DCON	H	LF	WF		DMIN	Sıkma Vidası Screw Зажимной винт	Altık Shim Опорная пластина	Altık Vidası Shim Screw Винт опорной пластины	Tork Anahtar Torx Key Торх Ключ
S25S SVJBR/L 16	●	●	25	23	250	17	≥32	VB.T 1604..	4015-M3.5x12	AAVN-2-0002	AAV-08-M3.5x8	80-T15
S32T SVJBR/L 16	●	●	32	30	300	22	≥40					
S40U SVJBR/L 16	●	●	40	37.5	350	27	≥50					

R: Sağ / Right / Правый L: Sol / Left / Левый
● Stokta / In Stock / В наличии ○ Stokta Yok / Non Stock Item / Нет в наличии

Sipariş Örneği/Ordering Example/Образец заказа
1 ad./pcs./шт. S08H STUPR 0802

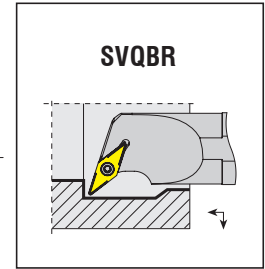
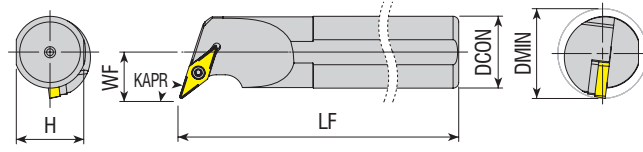

Takım Kodu
Ordering Code
Код для заказа

Stok
Stock
Наличие

Takım Ölçüleri (mm)
Dimension (mm)
Размеры (мм)

Kesici Uç
Insert
Пластина

Sıkma Vidası
Screw
Зажимной винт

Altık Shim
Опорная пластина

Altık Vidası
Shim Screw
Вит опорной пластины

Tork Anahtar
Torx Key
Торх Ключ

Yedek Parçaları / Spare Parts / Запасные части

R	L	DCON	H	LF	WF	DMIN					
●	●	16	14.8	170	11	≥20			-	-	
●	●	20	18.3	200	13	≥25	VB.T 1103..	4008-M2.5x6	-	-	82-T08
●	●	25	23	250	17	≥32	●	●	●	●	●
●	●	32	30	300	22	≥40					
●	●	40	37.5	350	27	≥50	●	●	●	●	●
●	●	20	18.5	180	13	≥25	VB.T 1103..	4008-M2.5x6	-	-	82-T08
●	●	20	18.5	180	20	≥30	●	●	●	●	●
●	●	25	23	250	17	≥32					
●	●	32	30	250	22	≥40	●	●	●	●	●

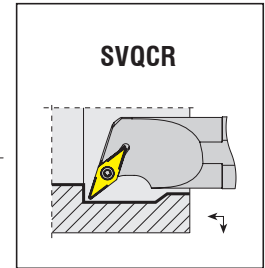
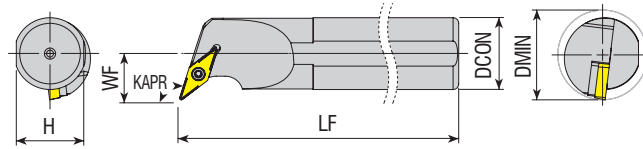

Takım Kodu
Ordering Code
Код для заказа

Stok
Stock
Наличие

Takım Ölçüleri (mm)
Dimension (mm)
Размеры (мм)

Kesici Uç
Insert
Пластина

Sıkma Vidası
Screw
Зажимной винт

Altık Shim
Опорная пластина

Altık Vidası
Shim Screw
Вит опорной пластины

Tork Anahtar
Torx Key
Торх Ключ

Yedek Parçaları / Spare Parts / Запасные части

R	L	DCON	H	LF	WF	DMIN					
●	●	16	14.8	170	11	≥20			-	-	
●	●	20	18.3	200	13	≥25	VC.T 1103..	4008-M2.5x6	-	-	82-T08
●	●	25	23	250	17	≥32	●	●	●	●	●
●	●	32	30	300	22	≥40					
●	●	40	37.5	350	27	≥50	●	●	●	●	●
●	●	16	14.8	150	11	≥20	●	●	●	●	●
●	●	20	18.3	170	13	≥25					
●	●	25	23	200	17	≥32	●	●	●	●	●
●	●	32	30	250	22	≥40					
●	●	40	37.5	300	27	≥50	●	●	●	●	●

R: Sağ / Right / Правый L: Sol / Left / Левый

● Stokta / In Stock / В наличии ○ Stokta Yok / Non Stock Item / Нет в наличии

Sipariş Örneği/Ordering Example/Образец заказа

1 ad./pcs./шт. S16P SVQBR 11

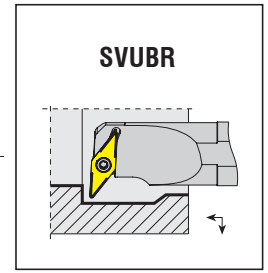
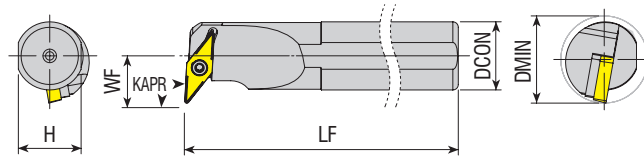

Takım Kodu Ordering Code Код для заказа	Stok Stock Наличие		Takım Ölçüleri (mm) Dimension (mm) Размеры (мм)					Kesici Uç Insert Пластина	Yedek Parçaları / Spare Parts / Запасные части			
	R	L	DCON	H	LF	WF	DMIN		Sıkma Vidası Screw Зажимной винт	Altlık Shim Опорная пластина	Altlık Vidası Shim Screw Винт опорной пластины	Tork Anahtar Torx Key Торх Ключ
S16P SVUBR/L 11	●	●	16	14.8	170	12.5	≥20	VB.T 1103..	4008-M2.5x6	-	-	82-T08
S20R SVUBR/L 11	●	●	20	18.3	200	13	≥25					
S25S SVUBR/L 16	●	●	25	23	250	19	≥32	VB.T 1604..	4015-M3.5x14	AAVN-2-0002	AAV-06-M3.5x11	80-T15
S32T SVUBR/L 16	●	●	32	30	300	22	≥40					
S40U SVUBR/L 16	●	●	40	37.5	350	27	≥50					
A20Q SVUBR/L 16	●	○	20	18.3	180	20	≥30					
A32S SVUBR/L 16	●	●	32	30	250	22	≥40	4015-M3.5x14	AAVN-2-0002	AAV-06-M3.5x11		

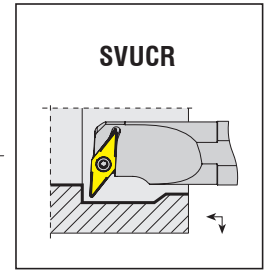
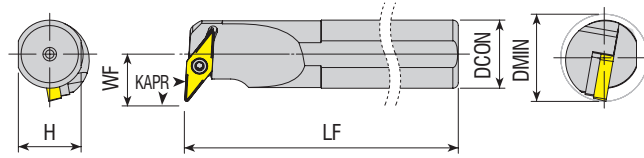

Takım Kodu Ordering Code Код для заказа	Stok Stock Наличие		Takım Ölçüleri (mm) Dimension (mm) Размеры (мм)					Kesici Uç Insert Пластина	Yedek Parçaları / Spare Parts / Запасные части			
	R	L	DCON	H	LF	WF	DMIN		Sıkma Vidası Screw Зажимной винт	Altlık Shim Опорная пластина	Altlık Vidası Shim Screw Винт опорной пластины	Tork Anahtar Torx Key Торх Ключ
S16P SVUCR/L 11	●	●	16	14.8	170	12.5	≥20	VC.T 1103..	4008-M2.5x6	-	-	82-T08
S20R SVUCR/L 11	●	●	20	18.3	200	13	≥25					
S25S SVUCR/L 16	●	●	25	23	250	19	≥32	VC.T 1604..	4015-M3.5x14	AAVN-2-0002	AAV-06-M3.5x11	80-T15
S32T SVUCR/L 16	●	●	32	30	300	22	≥40					
S40U SVUCR/L 16	●	●	40	37.5	350	27	≥50					
A12K SVUCR/L 07	●	●	12	11	125	9	≥16					
A20P SVUCR/L 11	●	○	20	18.3	170	13	≥25	VC.T 1103..	4008-M2.5x6	-	-	82-T08
A20Q SVUCR/L 11	●	●	20	18.3	180	13	≥25	VC.T 1604..	4015-M3.5x14	AAVN-2-0002	AAV-06-M3.5x11	80-T15
A25R SVUCR/L 16	●	●	25	23	200	19	≥32					

R: Sağ / Right / Правый L: Sol / Left / Левый
● Stokta / In Stock / В наличии ○ Stokta Yok / Non Stock Item / Нет в наличии

Sipariş Örneği/Ordering Example/Образец заказа
1 ad./pcs./шт. S16P SVUBR 11

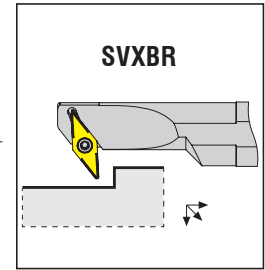
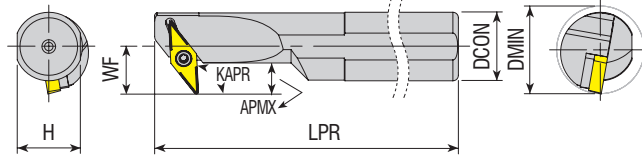

Takım Kodu Ordering Code Код для заказа	Stok Stock Наличие	Takım Ölçüleri (mm) Dimension (mm) Размеры (мм)						Kesici Uç Insert Пластина	Yedek Parçaları / Spare Parts / Запасные части			
		R	L	DCON	H	LPR	WF		APMX	DMIN	Sıkma Vidası Screw Зажимной винт	Altılık Shim Опорная пластина
S16P SVXBR/L 1102	● ○	16	14.8	170	12.5	7.2	≥20	VBM. 1102..	4008-M2.5x6	-	-	82-T08
S20R SVXBR/L 1102	● ●	20	18.3	200	13	5.7	≥25					
S16P SVXBR/L 11	● ●	16	14.8	170	12.5	7.2	≥20	VB.T 1103..				
S20R SVXBR/L 11	● ●	20	18.3	200	13	5.7	≥25					
S25S SVXBR/L 16	● ●	25	23	250	19	10.2	≥32	VB.T 1604..	4015-M3.5x14	AAVN-2-0002	AAV-06-M3.5x11	80-T15
S32T SVXBR/L 16	● ●	32	30	300	22	11.7	≥40					
S40U SVXBR/L 16	● ●	40	37.5	350	27	14.3	≥50					

Not: "APMX" ölçüleri R0.4'e göre verilmiştir.
Note: Dimensions of "APMX" are given according to R0.4
Примечание: размеры должны быть R.04

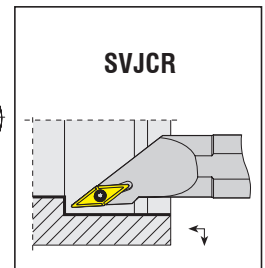
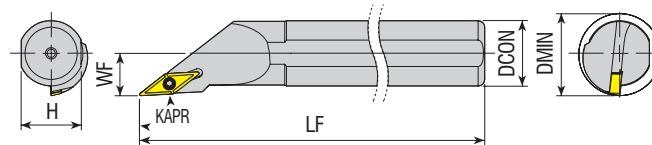

Takım Kodu Ordering Code Код для заказа	Stok Stock Наличие	Takım Ölçüleri (mm) Dimension (mm) Размеры (мм)						Kesici Uç Insert Пластина	Yedek Parçaları / Spare Parts / Запасные части			
		R	L	DCON	H	LF	WF		DMIN	Sıkma Vidası Screw Зажимной винт	Altılık Shim Опорная пластина	Altılık Vidası Shim Screw Винт опорной пластины
S12K SVJCR/L 11	● ●	12	11	125	7	≥13	VC.T 1103..	4008-M2.5x6	-	-	82-T08	
S16P SVJCR/L 11	● ●	16	14.8	170	11	≥20						
S20R SVJCR/L 11	● ●	20	18.3	200	13	≥25						
A12H SVJCR/L 11	● ●	12	11	100	07	≥13						
A16M SVJCR/L 11	● ●	16	14.8	150	11	≥20						
A20P SVJCR/L 11	● ●	20	18.3	170	13	≥25						

R: Sağ / Right / Правый L: Sol / Left / Левый
● Stokta / In Stock / В наличии ○ Stokta Yok / Non Stock Item / Нет в наличии

Sipariş Örneği/Ordering Example/Образец заказа
1 ad./pcs./шт. S16P SVXBR 1102

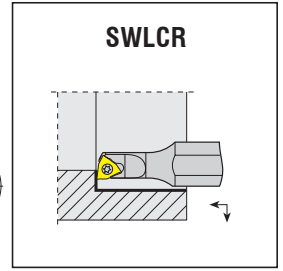
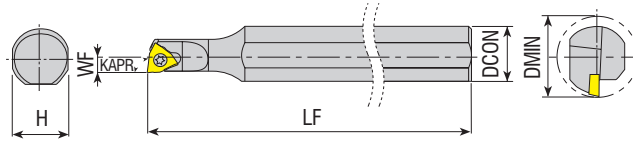

Takım Kodu Ordering Code Код для заказа	Stok Stock Наличие		Takım Ölçüleri (mm) Dimension (mm) Размеры (мм)				Kesici Uç Insert Пластина	Yedek Parçaları / Spare Parts / Запасные части				
	R	L	DCON	H	LF	WF		DMIN	Sıkma Vidası Screw Зажимной винт	Altık Shim Опорная пластина	Altık Vidası Shim Screw Винт опорной пластины	Tork Anahtar Torx Key Торх Ключ
S0608H SWLCR/L 03	●	○	08	7.3	100	04	≥08	WC.. 0302..	4008-M2.5x4	-	-	82-T08
S0810K SWLCR/L 03	●	○	10	09	125	06	≥10		4008-M2.5x4.5			

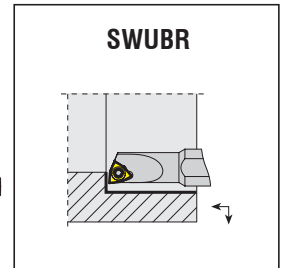
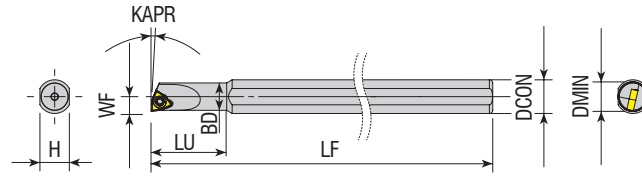

Takım Kodu Ordering Code Код для заказа	Stok Stock Наличие		Takım Ölçüleri (mm) Dimension (mm) Размеры (мм)						Kesici Uç Insert Пластина	Yedek Parçaları / Spare Parts / Запасные части				
	R	L	DCON	BD	H	LU	LF	DMIN		WF	Sıkma Vidası Screw Зажимной винт	Altık Shim Опорная пластина	Altık Vidası Shim Screw Винт опорной пластины	Tork Anahtar Torx Key Торх Ключ
S0610H SWUBR/L 06	●	○	10	5	7.3	18	100	≥6	3	WBGT 060102-L	3006-M2x3.3	-	-	82-T06
new S08H SWUBR/L 06-5.5	●	●	08	5	7.3	18	100	≥5.7	2.75		3006-M2x4			
S08H SWUBR/L 06-7	●	○	08	6.5	7.3	18	100	≥7	3.5		WBGT 060102-R			

R: Sağ / Right / Правый L: Sol / Left / Левый

● Stokta / In Stock / В наличии ○ Stokta Yok / Non Stock Item / Нет в наличии

KYCR-İSCR Ucuna Uygundur. / Compatible with KYCR-İSCR Insert. / Под пластину KYCR-İSCR

Sipariş Örneği/Ordering Example/Образец заказа

1 ad./pcs./шт. S0608H SWLCR 03

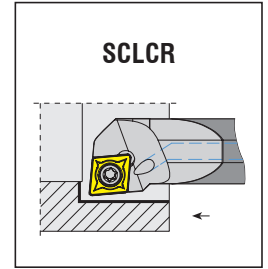
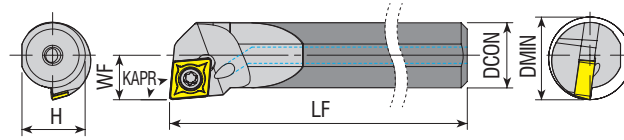

Takım Kodu Ordering Code Код для заказа	Stok Stock Наличие		Takım Ölçüleri (mm) Dimension (mm) Размеры (мм)					Kesici Uç Insert Пластина	Yedek Parçaları / Spare Parts / Запасные части			
	R	L	DCON	H	LF	WF	DMIN		Sıkma Vidası Screw Зажимной винт	Altlık Shim Опорная пластина	Altlık Vidası Shim Screw Винт опорной пластины	Tork Anahtar Torx Key Торх Ключ
new C04G SCLCR/L 03	●	○	4	3.7	90	2.5	≥5	CC. 0301..	4006-M1.6x3.2			82-T06
new C05H SCLCR/L 03	●	○	5	4.7	100	3	≥6					
new C06J SCLCR/L 04	●	○	6	5.7	110	3.5	≥7	CC. 0401..	3006-M2x3.3			82-T08
new C07K SCLCR/L 04	●	○	7	6.7	125	4	≥8					
C06J SCLCR/L 06	●	○	6	5.7	110	4.5	≥8	CC.T 0602..	4008-M2.5x4.5	-	-	82-T08
E08K SCLCR/L 06	●	●	8	7.5	125	6	≥11					
E10M SCLCR/L 06	●	●	10	9.5	150	7	≥13					
E12Q SCLCR/L 06	●	●	12	11	180	9	≥16	CC.T 09T3..	4015-M3.5x9			80-T15
E16R SCLCR/L 09	●	●	16	15	200	11	≥20					
E20S SCLCR/L 09	●	●	20	19	250	13	≥24					

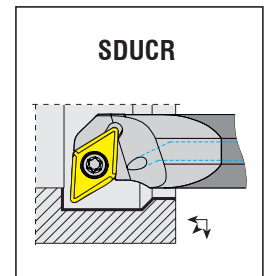
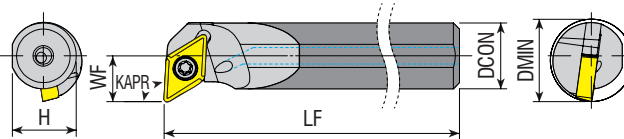

Takım Kodu Ordering Code Код для заказа	Stok Stock Наличие		Takım Ölçüleri (mm) Dimension (mm) Размеры (мм)					Kesici Uç Insert Пластина	Yedek Parçaları / Spare Parts / Запасные части			
	R	L	DCON	H	LF	WF	DMIN		Sıkma Vidası Screw Зажимной винт	Altlık Shim Опорная пластина	Altlık Vidası Shim Screw Винт опорной пластины	Tork Anahtar Torx Key Торх Ключ
E10M SDUCR/L 07	●	●	10	9.5	150	8	≥13	DC.T 0702..	4008-M2.5x6	-	-	82-T08
E12Q SDUCR/L 07	●	●	12	11	180	9	≥16					
E16R SDUCR/L 11	●	●	16	15	200	11	≥20	DC.T 11T3..	4015-M3.5x9	-	-	80-T15
E20S SDUCR/L 11	●	●	20	18.3	250	12	≥23					

R: Sağ / Right / Правый L: Sol / Left / Левый

● Stokta / In Stock / В наличии ○ Stokta Yok / Non Stock Item / Нет в наличии

Sipariş Örneği/Ordering Example/Образец заказа

1 ad./pcs./шт. C04G SCLCR 03

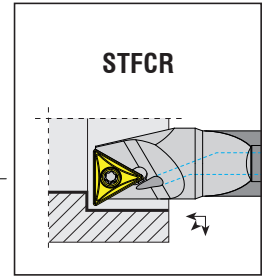
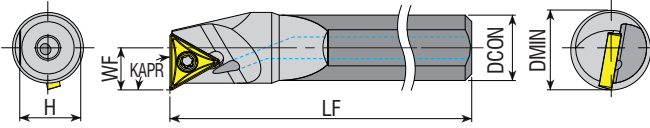

Takım Kodu Ordering Code Код для заказа	Stok Stock Наличие		Takım Ölçüleri (mm) Dimension (mm) Размеры (мм)				Kesici Uç Insert Пластина	Yedek Parçaları / Spare Parts / Запасные части				
	R	L	DCON	H	LF	WF		DMIN	Sıkma Vidası Screw Зажимной винт	Altık Shim Опорная пластина	Altık Vidası Shim Screw Винт опорной пластины	Tork Anahtar Torx Key Торх Ключ
E10M STFCR/L 09	●	●	10	9.5	150	6	12	TC.T 0902..	3007-M2.2x5	-	-	82-T07
E12Q STFCR/L 09	●	●	12	11	180	8	15					
E12Q STFCR/L 11	●	●	12	11	180	8	15					

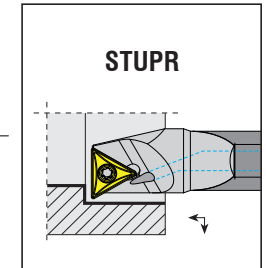
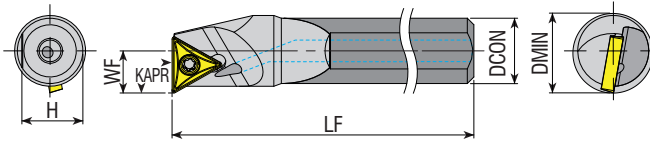

Takım Kodu Ordering Code Код для заказа	Stok Stock Наличие		Takım Ölçüleri (mm) Dimension (mm) Размеры (мм)				Kesici Uç Insert Пластина	Yedek Parçaları / Spare Parts / Запасные части				
	R	L	DCON	H	LF	WF		DMIN	Sıkma Vidası Screw Зажимной винт	Altık Shim Опорная пластина	Altık Vidası Shim Screw Винт опорной пластины	Tork Anahtar Torx Key Торх Ключ
E12Q STUPR/L 1103	●	○	12	11	180	8	15	TP. 1103..	4010-M3x6	-	-	82-T10
E16R STUPR/L 1103	●	○	16	15	200	11	20					

R: Sağ / Right / Правый L: Sol / Left / Левый
● Stokta / In Stock / В наличии ○ Stokta Yok / Non Stock Item / Нет в наличии

Sipariş Örneği/Ordering Example/Образец заказа
1 ad./pcs./шт. E10M STFCR 09

SCLCR

SET-A/SCLCR/L

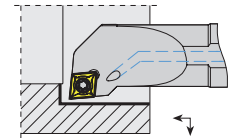
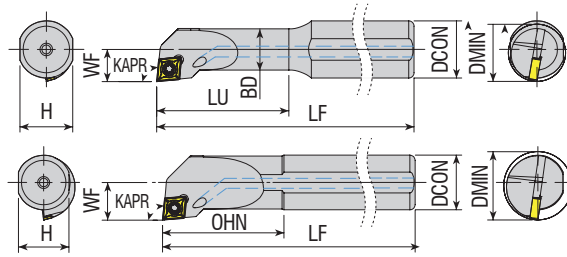

Takım Kodu
Ordering Code
Код для заказа

A08H SCLCR/L 06
A10H SCLCR/L 06
A12H SCLCR/L 06
A16M SCLCR/L 09

Stok Stock Наличие	Takım Ölçüleri (mm) Dimension (mm) Размеры (мм)								Kesici Uç Insert Пластина	Yedek Parçaları / Spare Parts / Запасные части			
	R	L	DCON	BD	H	LU=OHN	LF	WF		DMIN	Sıkma Vidası Screw Зажимной винт	Altılık Shim Опорная пластина	Altılık Vidası Shim Screw Винт опорной пластины
●●	●●	8	8	7.3	20	100	6	≥11	CC.T 0602..	4008-M2.5x6	-	-	82-T08
●●	●●	10	10	9	25	100	7	≥13					
●●	●●	12	12	11	25	100	9	≥16					
●●	●●	16	16	14.8	35	150	11	≥20					

SET-E/SCLCR/L

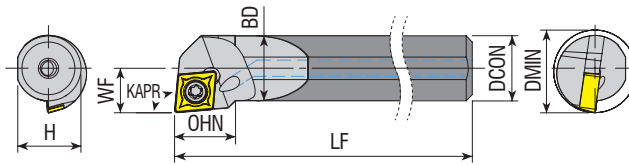

SCLCR

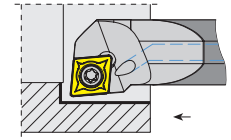

Takım Kodu
Ordering Code
Код для заказа

E08K SCLCR/L 06
E10M SCLCR/L 06
E12Q SCLCR/L 06
E16R SCLCR/L 09

Stok Stock Наличие	Takım Ölçüleri (mm) Dimension (mm) Размеры (мм)								Kesici Uç Insert Пластина	Yedek Parçaları / Spare Parts / Запасные части			
	R	L	DCON	BD	H	OHN	LF	WF		DMIN	Sıkma Vidası Screw Зажимной винт	Altılık Shim Опорная пластина	Altılık Vidası Shim Screw Винт опорной пластины
●●	●●	8	8	7.5	10	125	6	≥11	CC.T 0602..	4008-M2.5x6	-	-	82-T08
●●	●●	10	10	9.5	10	150	7	≥13					
●●	●●	12	12	11	12	180	9	≥16					
●●	●●	16	16	15	15	200	11	≥20					

SET-S/SCLCR/L

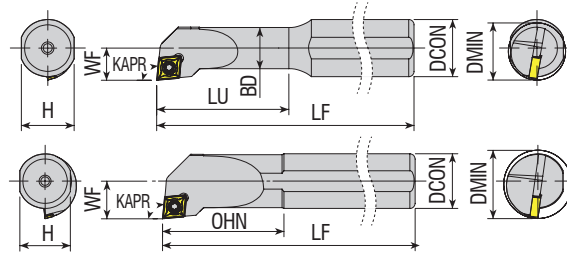

SCLCR

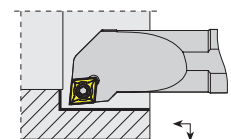

Takım Kodu
Ordering Code
Код для заказа

S08H SCLCR/L 06
S10K SCLCR/L 06
S12K SCLCR/L 06
S16P SCLCR/L 09

Stok Stock Наличие	Takım Ölçüleri (mm) Dimension (mm) Размеры (мм)								Kesici Uç Insert Пластина	Yedek Parçaları / Spare Parts / Запасные части			
	R	L	DCON	BD	H	LU=OHN	LF	WF		DMIN	Sıkma Vidası Screw Зажимной винт	Altılık Shim Опорная пластина	Altılık Vidası Shim Screw Винт опорной пластины
●●	●●	8	8	7.3	20	100	6	≥11	CC.T 0602..	4008-M2.5x6	-	-	82-T08
●●	●●	10	10	9	25	125	7	≥13					
●●	●●	12	12	11	25	125	9	≥16					
●●	●●	16	16	14.8	35	170	11	≥20					

SET-A/SDUCR/L

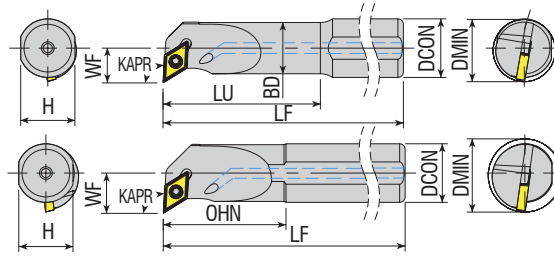

SDUCR

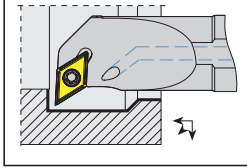

Takım Kodu
Ordering Code
Код для заказа

Stok
Stock
Наличие

Takım Ölçüleri (mm)
Dimension (mm)
Размеры (мм)

Kesici Uç
Insert
Пластина

Yedek Parçaları / Spare Parts / Запасные части

Sıkma Vidası
Screw
Зажимной винт

Altlık Shim
Опорная пластина

Altlık Vidası
Shim Screw
Винт опорной пластины

Tork Anahtar
Torx Key
Торх Ключ

R	L	DCON	BD	H	LU=OHN	LF	WF	DMIN
---	---	------	----	---	--------	----	----	------

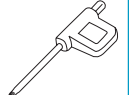
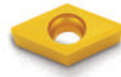

A10H SDUCR/L 07	●	●	10	10	09	25	100	08	≥13	DC.T 0702..	4008-M2.5x6	-	-	82-T08
A12H SDUCR/L 07	●	●	12	12	11	25	100	09	≥16	DC.T 11T3..	4015-M3.5x9	-	-	80-T15
A16M SDUCR/L 11	●	●	16	16	14.8	35	150	11	≥20	DC.T 11T3..	4015-M3.5x9	-	-	80-T15

SET-E/SDUCR/L

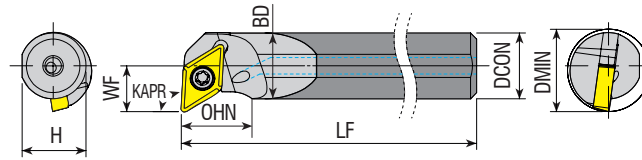

SDUCR

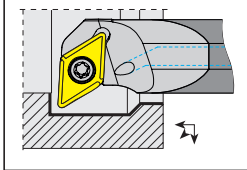

Takım Kodu
Ordering Code
Код для заказа

Stok
Stock
Наличие

Takım Ölçüleri (mm)
Dimension (mm)
Размеры (мм)

Kesici Uç
Insert
Пластина

Yedek Parçaları / Spare Parts / Запасные части

Sıkma Vidası
Screw
Зажимной винт

Altlık Shim
Опорная пластина

Altlık Vidası
Shim Screw
Винт опорной пластины

Tork Anahtar
Torx Key
Торх Ключ

R	L	DCON	BD	H	OHN	LF	WF	DMIN
---	---	------	----	---	-----	----	----	------

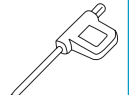
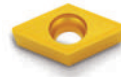

E10M SDUCR/L 07	●	○	10	10	9.5	09	150	8	≥13	DC.T 0702..	4008-M2.5x6	-	-	82-T08
E12Q SDUCR/L 07	●	○	12	12	11	10	180	9	≥16	DC.T 11T3..	4015-M3.5x9	-	-	80-T15
E16R SDUCR/L 11	●	○	16	16	15	12	200	11	≥20	DC.T 11T3..	4015-M3.5x9	-	-	80-T15

SET-S/SDUCR/L

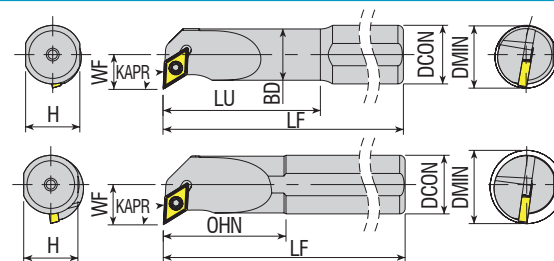

SDUCR

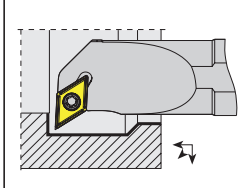

Takım Kodu
Ordering Code
Код для заказа

Stok
Stock
Наличие

Takım Ölçüleri (mm)
Dimension (mm)
Размеры (мм)

Kesici Uç
Insert
Пластина

Yedek Parçaları / Spare Parts / Запасные части

Sıkma Vidası
Screw
Зажимной винт

Altlık Shim
Опорная пластина

Altlık Vidası
Shim Screw
Винт опорной пластины

Tork Anahtar
Torx Key
Торх Ключ

R	L	DCON	BD	H	LU=OHN	LF	WF	DMIN
---	---	------	----	---	--------	----	----	------

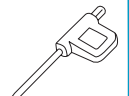
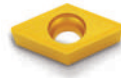

S10K SDUCR/L 07	●	●	10	10	9	25	125	8	≥13	DC.T 0702..	4008-M2.5x6	-	-	82-T08
S12K SDUCR/L 07	●	●	12	12	11	25	125	9	≥16	DC.T 11T3..	4015-M3.5x9	-	-	80-T15
S16P SDUCR/L 11	●	●	16	16	14.8	35	170	11	≥20	DC.T 11T3..	4015-M3.5x9	-	-	80-T15

R: Sağ / Right / Правый L: Sol / Left / Левый

● Stokta / In Stock / В наличии ○ Stokta Yok / Non Stock Item / Нет в наличии

Sipariş Örneği/Ordering Example/Образец заказа

1 ad./pcs./шт. SET-A/SDUCR



konusulan
the spoken kalite...
quality...

TIRLAMAZ

TIRLAMAZ TAKIMLAR
ANTIVIBRATION TOOLS
АНТИВИБРАЦИОННЫЕ ДЕРЖАВКИ



A **TT** **B** **D16** **204** **10D** **H** **E**

2 Takım Tipi <i>Tool Type</i> Тип Инструмента Tırlamaz Takım Anti Vibration Tool Антивибрационная Державка	3 Gövde <i>Body</i> Корпус	4 Bağlantı Çapı <i>Connection Diameter</i> Диаметр Соединение	5 Takım Boyu <i>Overall length</i> Общая Длина инструмента	6 Bağlama Boyu <i>Overhang maximum</i> Максимум длина соединения	7 İçten Soğutmalı <i>With Coolant Hole</i> С охлаждающим отверстием
8 Takım Malzemesi <i>Type of Boring Bar</i> Тип расточной оправки Karbür Takviyeli Carbide reinforced Армированный карбид					

A **TT** **C** **A** **16** **SDUCR11**

2 Takım Tipi <i>Tool Type</i> Тип Инструмента Tırlamaz Takım Kartuşu Anti Vibration Tool Cartridge Картриджи для Антивибрационных инструментов	3 Kartuş Kodu <i>Cartridge Code</i> Код картриджа Kartuş Cartridge Картридж	4 İçten Soğutmalı <i>With Coolant Hole</i> С охлаждающим отверстием	5 Bağlama Çapı <i>Connection Diameter</i> Диаметр Соединение Ø16 - Ø20 - Ø25 Ø32 - Ø40
2 Kartuş Tipi <i>Cartridge Type</i> Тип Картриджа SDUCR/L, SCLCR/L, SVUCR/L, TCLNR/L, TDUNR/L			

A **TT** **C** **16-25**

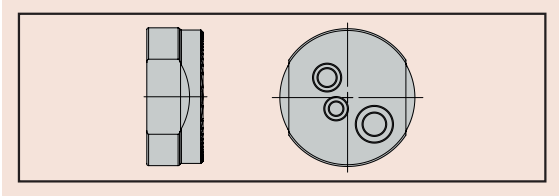

2 Takım Tipi <i>Tool Type</i> Тип Инструмента Tırlamaz Takım Kartuşu Anti Vibration Tool Cartridge Картриджи для Антивибрационных инструментов	3 Kartuş <i>Cartridge</i> Картридж Merkezeleme Kartuş Kodu Centering Cartridge Code Код для центрирующего картриджа	4 Kullanılan Gövde Çap Aralığı <i>Usable diameter range for body</i> Используемый диапазон диаметров для корпуса ATTB-D16/D20/D25 ATTB-D32/D40/D50/D60
--	---	---

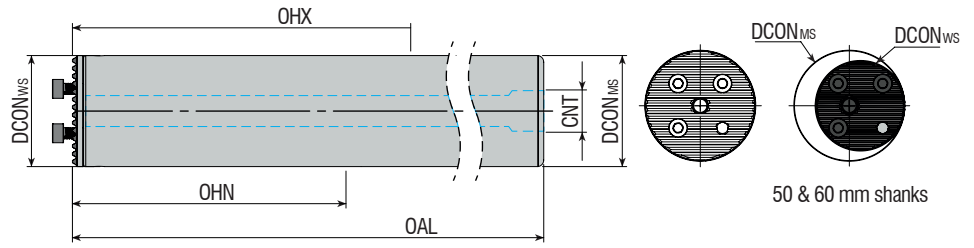

Takım Kodu Ordering Code Код для заказа	Stok Stock Наличие	Takım Ölçüleri (mm) Dimension (mm) Размеры (мм)							Yedek Parçaları / Spare Parts / Запасные части		
		DCONMS	DCONWS	OAL	OHN	OHX	CNT	Montaj Vidası Shim Screw Винт опорной пластины		Montaj Vida Anahtar Mounting Screw Key Монтажный винт столовой под шестигранник	
								DCON	DMIN		
ATTB-D16-156-7D-H	○	16	16	156	55	92	G1/8	16	20	2525-M3X10	AAL-02-2.5
ATTB-D16-204-10D-H-E	○	16	16	204	96	140	G1/8	16	20		
ATTB-D20-200-7D-H	○	20	20	200	70	120	G1/4	20	25	2503-M3.5x10	AAL-03-3
ATTB-D20-260-10D-H-E	○	20	20	260	120	180	G1/4	20	25		
ATTB-D25-255-7D-H	●	25	25	255	88	158	G1/4	25	32	2503-M4X12	AAL-05-4
ATTB-D25-330-10D-H	○	25	25	330	155	230	G1/4	25	32		
ATTB-D32-320-7D-H	●	32	32	320	100	192	G3/8	32	40	2504-M5X16	AAL-07-5
ATTB-D32-416-10D-H	○	32	32	416	192	288	G3/8	32	40		
ATTB-D40-408-7D-H	●	40	40	408	128	248	G1/2	40	50	2505-M6X16	AAL-07-5
ATTB-D40-528-10D-H	○	40	40	528	248	368	G1/2	40	50		
ATTB-D50-519-7D-H	●	50	40	519	168	318	G1/2	40	63	2505-M6X16	AAL-07-5
ATTB-D50-669-10D-H	○	50	40	669	318	468	G1/2	40	63		
ATTB-D60-628-7D-H	●	60	40	628	208	388	G3/4	40	80	2505-M6X16	AAL-07-5
ATTB-D60-808-10D-H	○	60	40	808	388	568	G3/4	40	80		

R: Sağ / Right / Правый L: Sol / Left / Левый

● Stokta / In Stock / В наличии ○ Stokta Yok / Non Stock Item / Нет в наличии

Sipariş Örneği/Ordering Example/Образец заказа

1 ad./pcs./шт. ATTB-D16-156-7D-H



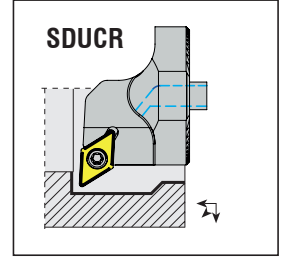
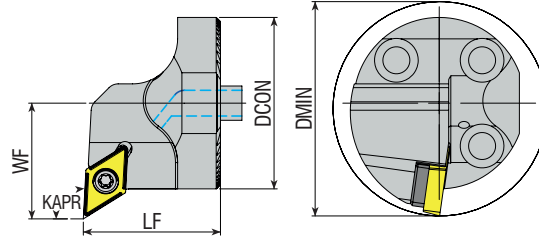

Takım Kodu Ordering Code Код для заказа	Stok Stock Наличие		Takım Ölçüleri (mm) Dimension (mm) Размеры (мм)				Kesici Uç Insert Пластина	Sıkma Vidası Screw Зажимной винт	Yedek Parçaları / Spare Parts / Запасные части		Bağlantı Parçası Connection Part Соединительная часть	Tork Anahtar Torx Key Торх Ключ
	R	L	DCON	LF	WF	DMIN			Altlık Shim Отпорная пластина	Altlık Vidası Shim Screw Винт отпорной пластины		
ATTC-A16 SDUCR/L 07	●	●	16	20	11	20	DC.T 0702..	4008-M2.5x6	-	-	ACP-02	82-T08
ATTC-A20 SDUCR/L 11	●	●	20	20	13	25	DC.T 11T3..	4015-M3.5x11	-	-	ACP-01	80-T15
ATTC-A25 SDUCR/L 11	●	●	25	23	17	32		4015-M3.5x12	-	AAV-08-M3.5x8		
ATTC-A32 SDUCR/L 11	●	●	32	32	22	40		4015-M3.5x14	AADN-2-0001	AAV-06-M3.5x11		
ATTC-A40 SDUCR/L 11	●	●	40	32	27	50						

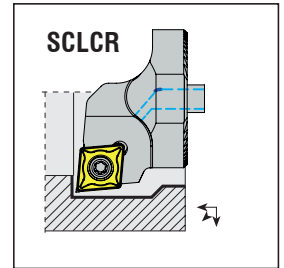
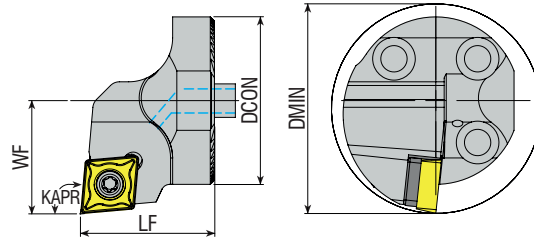

Takım Kodu Ordering Code Код для заказа	Stok Stock Наличие		Takım Ölçüleri (mm) Dimension (mm) Размеры (мм)				Kesici Uç Insert Пластина	Sıkma Vidası Screw Зажимной винт	Yedek Parçaları / Spare Parts / Запасные части		Bağlantı Parçası Connection Part Соединительная часть	Tork Anahtar Torx Key Торх Ключ
	R	L	DCON	LF	WF	DMIN			Altlık Shim Отпорная пластина	Altlık Vidası Shim Screw Винт отпорной пластины		
ATTC-A16 SCLCR/L 06	●	●	16	20	11	20	CC.T 0602..	4008-M2.5x6	-	-	ACP-02	82-T08
ATTC-A20 SCLCR/L 09	●	●	20	20	13	25	CC.T 09T3..	4015-M3.5x9	-	-	ACP-01	80-T15
ATTC-A25 SCLCR/L 09	●	●	25	23	17	32		4015-M3.5x12	AACN-2-0001	AAV-08-M3.5x8		
ATTC-A32 SCLCR/L 09	●	●	32	32	22	40		1020-M4.5x16	AACN-2-0003	AAV-07-M4.5x13		
ATTC-A40 SCLCR/L 12	●	●	40	32	27	50	CC.T 1204..					

R: Sağ / Right / Правый L: Sol / Left / Левый
● Stokta / In Stock / В наличии ○ Stokta Yok / Non Stock Item / Нет в наличии

Sipariş Örneği/Ordering Example/Образец заказа
1 ad./pcs./шт. ATTC-A16-SDUCR 07

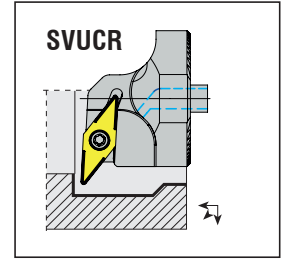
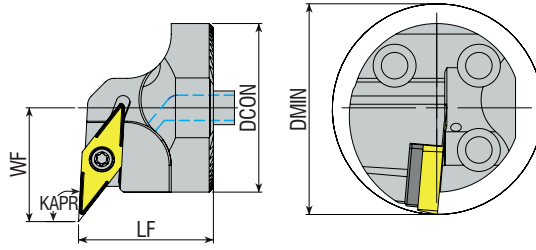

Takım Kodu Ordering Code Код для заказа	Stok Stock Наличие		Takım Ölçüleri (mm) Dimension (mm) Размеры (мм)				Kesici Uç Insert Пластина	Sıkma Vidası Screw Зажимной винт	Yedek Parçaları / Spare Parts / Запасные части			
	R	L	DCON	LF	WF	DMIN			Altık Shim Отпорная пластина	Altık Vidası Shim Screw Винт отпорной пластины	Bağlantı Parçası Connection Part Соединительная часть	Tork Anahtar Torx Key Торх Ключ
ATTC-A20 SVUCR/L 11	●	●	20	20	15	27			-	-		
ATTC-A25 SVUCR/L 11	●	●	25	23	17	32	VC.T 1103..	4008-M2.5x6	-	-	ACP-02	82-T08
ATTC-A32 SVUCR/L 16	●	●	32	32	22	40	VC.T 1604..	4015-M3.5x14	AAVN-2-0002	AAV-06-M3.5x11	ACP-01	80-T15
ATTC-A40 SVUCR/L 16	●	●	40	32	27	50						

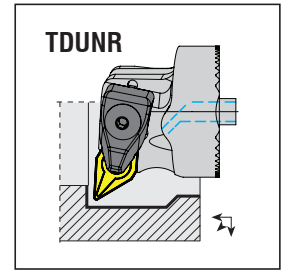
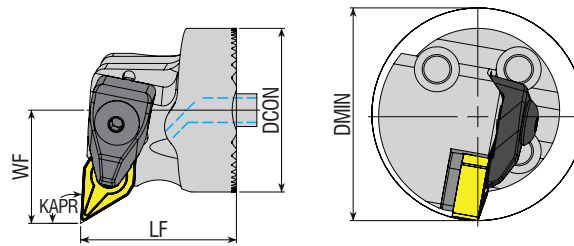

Takım Kodu Ordering Code Код для заказа	Stok Stock Наличие		Takım Ölçüleri (mm) Dimension (mm) Размеры (мм)				Kesici Uç Insert Пластина	Baskı Vapucu Wedge Clamp Прижим	Pabuç Vidası Clamp Screw Зажимной	Altık Shim Отпорная пластина	Altık Vidası Shim Screw Винт отпорной пластины	Segman Ring Кольцо	Pul Stamp Шайба	Bağlantı Parçası Connection Part Соединительная часть	Anahtar Allen Key Ключ
	R	L	DCON	LF	WF	DMIN									
ATTC-A32 TDUNR/L 11	●	●	32	32	22	40									
ATTC-A40 TDUNR/L 15	●	●	40	38	27	50	DNM. 1104..	ATK-01	AKV-01-M5x22	AADN -2-0001	AAV-04-M5x12	AS-01	ABPL-01	ACP-01	AAL-03-3
							DNM. 1506..	ATK-02	AKV-30-M6x22	AADN -3-0001	AAV-02-M5x12				

R: Sağ / Right / Правый L: Sol / Left / Левый

● Stokta / In Stock / В наличии ○ Stokta Yok / Non Stock Item / Нет в наличии

Sipariş Örneği/Ordering Example/Образец заказа

1 Ad./PCS./шт. ATTC-A20 SVUCR 11

► TIRLAMAZ TAKIMLARIN KARTUŞLARI
ANTI VIBRATION TOOLS CARTRIDGES
КАРТРИДЖИ ДЛЯ АНТИВИБРАЦИОННОЙ РАСТОЧНОЙ ДЕРЖАВКИ

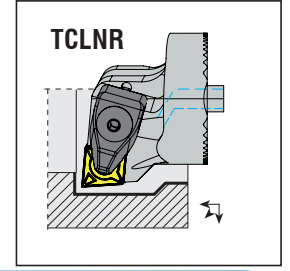
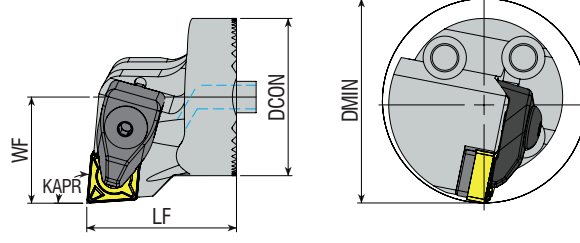

Takım Kodu
Ordering Code
Код для заказа

Stok Stock Наличие	Takım Ölçüleri (mm) Dimension (mm) Размеры (мм)					Kesici Uç Insert Пластина	Baskı Vapucu Wedge Clamp Прижим	Pabuç Vidası Clamp Screw Зажимной	Aitlik Shim Отпорная пластина	Aitlik Vidası Shim Screw Винт отпорной пластины	Segman Ring Кольцо	Pul Stamp Шайба	Bağlantı Parçası Connection Part Соединительная часть	Anahtar Allen Key Ключ
	R	L	DCON	LF	WF									
●	●	32	32	22	40	CNM. 1204..	ATK-02	AKV-30-M6x22	AACN-3-0001	AAV-02-M5x12	AS-01	ABPL-01	ACP-01	AAL-03-3
●	●	40	38	27	50									

► TIRLAMAZ TAKIMLARIN MERKEZLEME APARATI
ANTI VIBRATION TOOLS CENTERING INSTRUMENT
НАСАДКА ДЛЯ КАЛИБРОВАНИЯ КАРТРИДЖА АНТИВИБРАЦИОННОГО РЕЗЦА

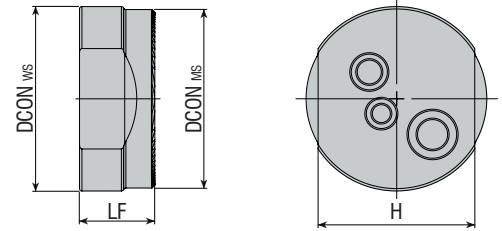

Stok Stock Наличие	Takım Ölçüleri (mm) Dimension (mm) Размеры (мм)				Gövde Tipi Booring Bars Борштанги
	DCONWS	DCONMS	LF	H	
●	28	25	15	22	ATTB-D16/D20/D25
●	53	40	20	35	ATTB-D32/D40/D50/D60

R: Sağ / Right / Правый L: Sol / Left / Левый
● Stokta / In Stock / В наличии ○ Stokta Yok / Non Stock Item / Нет в наличии

Sipariş Örneği/Ordering Example/Образец заказа
1 ad./pcs./шт. ATTC-A32 TCLNR 12

1 Montaj ve Ayarlama | Assembly and Adjusting | Сборка и установка

Kartuş ve gövdenin montaj edilecek yüzeyleri, tutucunun iç kısmı temizlenmelidir. Aşağıdaki görselde A ve B konumlarına bakın.

The surface of the cartridge and the shank to be mounted, as well as the inner part of the toolholder should be cleaned. Check A and B in the image below.

Посадочные поверхности борштанги (А) и резцовой головки (В) должны быть очищены перед сборкой.

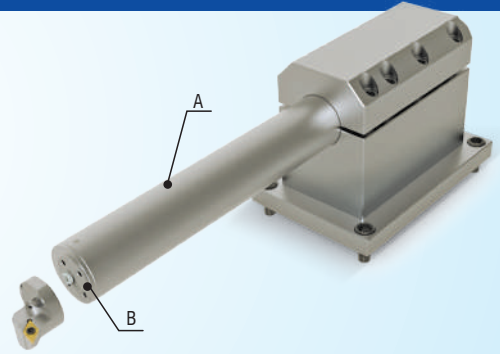

2 Gövde Montajı | Assembly for the Shank | Резцедержатель

Bağlama uzunluğu 4 L / D oranından az olmamalıdır. Tutucunun üst kısmını çıkartma yöntemiyle veya diğer tutma sıkma yöntemleriyle kullanmanızı öneririz (C tipi). Vidalı bağlama yöntemi kullanmayın. Uzun süre çalışırken lütfen içten soğutmayı kullanın.

The clamping length should not be less than 4 L/D ratio. Suggest using the clamping cover with opening method and other holding clamping methods. (Type C). Do not use screw clamping method. Use inner cooling please when working a long time.

Длина закрепления не менее 4 диаметров хвостовика. Резцедержатель должен обеспечивать большую площадь обхвата и concentricность (тип C). Закрепление борштанг винтом не допускается. Используйте внутренний подвод СОЖ непрерывно во время работы, а так же некоторое время до начала работы

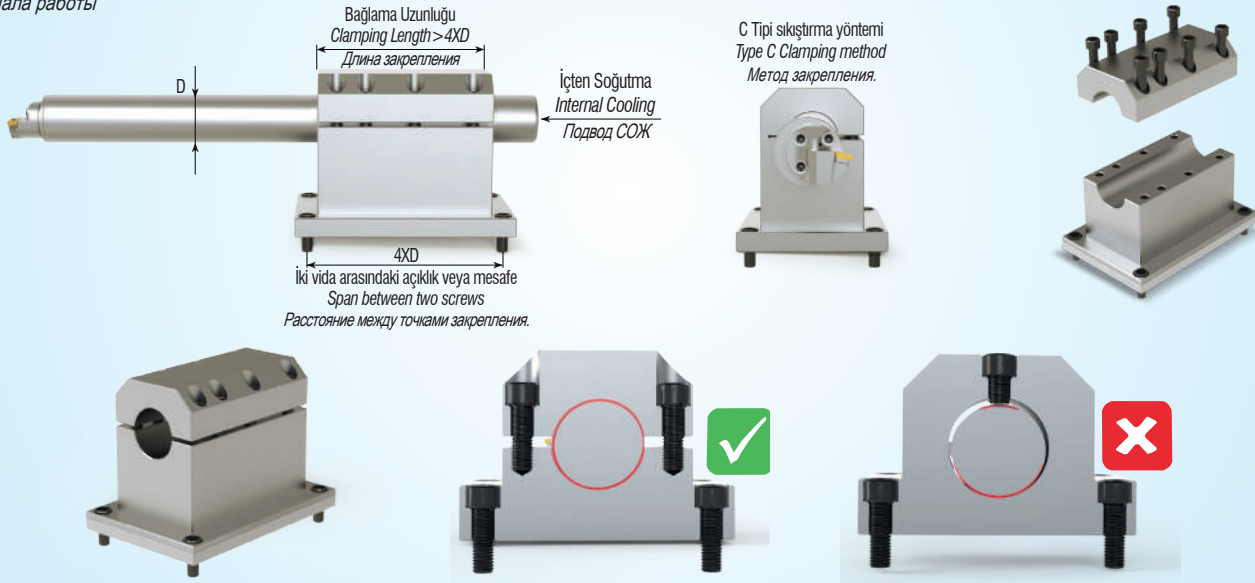

3 Merkez Yüksekliğinin Ayarlanması | Adjusting the Height of Centre Assembly | Установка высоты центра

Gövdeyi ilk kez montaj ederken merkez yüksekliği için özel kalibrasyon aparatı kullanılmalıdır. Önce gövdeyi tutucuya monte edin, ardından X ekseninde 0,01 tolerans içinde kalibre edin. Lütfen komparatör saati ile ayarlamayı yapın.

When mounting the body for the first time, a special calibration tool should be used for the center height. First mount the shank on the holder, then calibrate it within 0.01 tolerance on the X axis direction. Please make the adjustment with the dial indicator device.

Для большей жёсткости борштанги изготавливают с цилиндрическим хвостовиком. После монтажа борштанги её необходимо откалибровать. Установите насадку для калибрования картриджа и с помощью индикатора часового типа проконтролируйте точность установки вдоль оси "X" (необходимо добиться погрешность в пределах 10 мкм).

Kalibrasyon Yüzeyi
 Calibrating end face
 Плоская поверхность для калибровки.

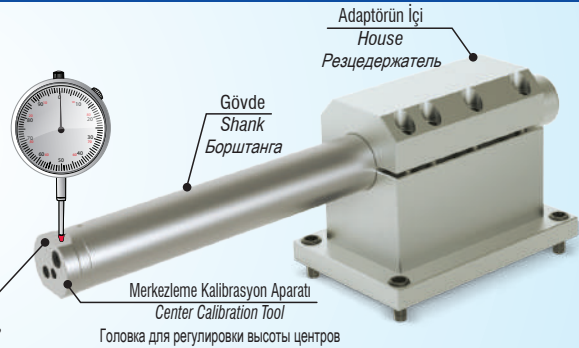

4 Doğru Kartuş Montajı | Assembly the Right Cartridge | Сборка

Yandaki şekle bakın:
 See the figure on the side:
 Смотри рисунок сбоку

Sol Yön Takım
 Left Hand
 Левое исполнение



Sağ Yön Takım
 Right Hand
 Правое исполнение



Doğru Uç Seçimi / Choosing the Correct Insert / Рекомендации по подбору твердосплавных пластин

Doğru kesici ucun seçilmesi, titreşim sönümlenmenin genel başarısı üzerinde büyük bir etkiye sahiptir. Kesici ucun işleme stabilitesini artırabilmesinin ana yolu kesme kuvvetlerini en aza indirmektir. Titreşimleri ortadan kaldırmak için aşağıdaki adımlara uymanız gerekir: Mümkünse, her zaman kısa takımları kullanın. Aksi takdirde, titreşimi en aza indirmek için hızlarınızı azaltın.

Choosing the correct insert can have a big influence on the overall success of vibration damping. The main way the insert can improve the machining stability is by minimizing the cutting forces. Following the guidelines below should be your first step to eliminate vibrations: If possible, use it always short drilling tools. Otherwise, reduce your speeds to minimize vibration.

Правильный подбор твердосплавной пластины может оказать большое влияние на снижение вибрации. Основной задачей для стабильной обработки является снижение усилий резания, а это зависит от правильного выбора пластины. Следуя приведенным ниже рекомендациям, Вы можете снизить вибрации во время обработки. Если есть возможность, всегда используйте инструмент как можно меньшей длины. В противном случае уменьшите скорость, чтобы минимизировать вибрацию.

A Radyal kuvvetleri minimuma indirmek için mümkün olduğunca 90° 'ye yakın bir giriş açılı takımı seçin.

Choose an entry angle that is as close as possible to 90° to reduce the radial forces to a minimum.

Выбирайте угол в плане (КАРР) близкий к 90° - в этом случае радиальная сила резания будет ниже.

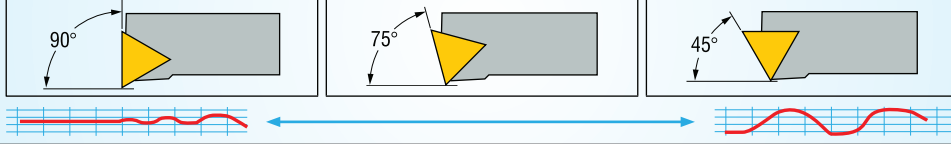
**B** Mümkün olan en küçük kesici uç açısını seçin. Böylece kesme kuvvetleri azalacak ve yüzey kalitesi artacak.

Choose the smallest insert head angle possible. This will reduce overall cutting forces and increase the clearance.

Склонность к вибрациям растёт слева направо. С увеличением угла при вершине пластины увеличивается усилие резания.

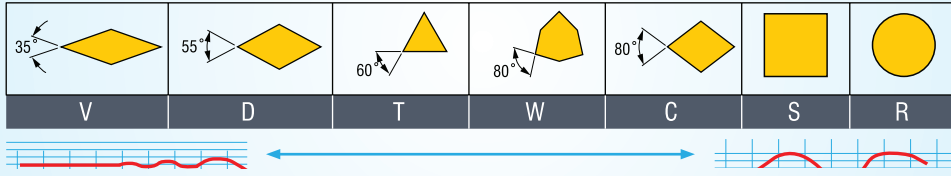
**C** Titreşimi azaltmak için olabildiğince en küçük radyüslü ucu seçmelisiniz.

Choose a small nose radius to reduce the cutting forces and to enable machining in a lower depth of cut.

Меньший угол при вершине позволит снизить усилие резания, за счёт малых глубин резания и подач.

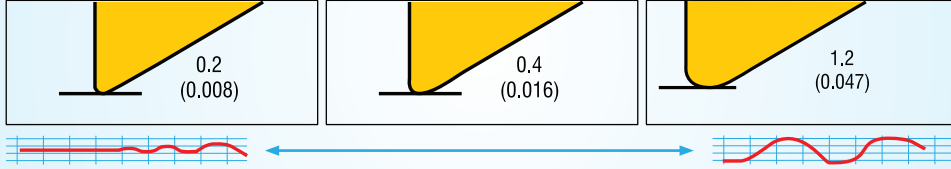
**D** İşleme derinliği (ap) radyüsten daha büyük olmalıdır.

Machining depth (ap) should be larger than the nose radius.

Глубина резания должна превышать радиус при вершине.

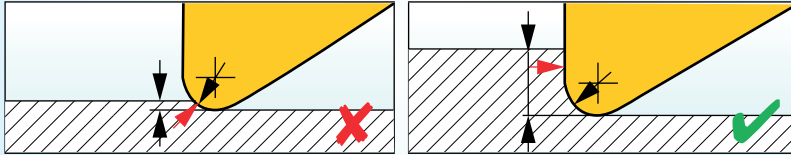
**E** Kesme kuvvetlerini azaltmak için daha pozitif geometriye sahip bir kesici uç kullanın:

Use an insert with an overall positive geometry to reduce the cutting forces:

Используйте пластины с задними углами, что бы снизить силы резания.

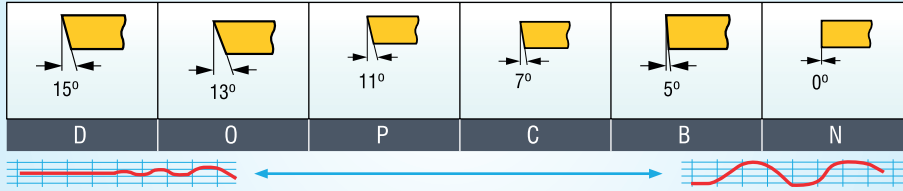
**F** Pozitif bir üst eğim geometrisi seçin:

Choose a positive top rake geometry:

Выбирайте "стружколомы" (формы передней поверхности СМГ) с большей величиной переднего угла.

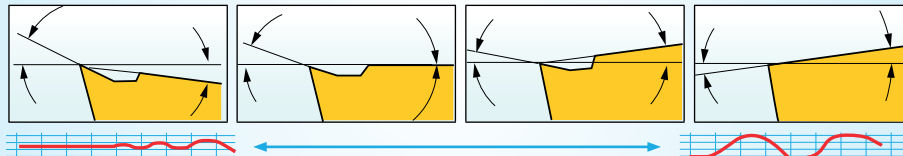
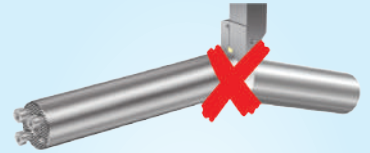
**G** For-dampened-straight-adaptor:

L, kesildikten sonra min uzunluk

L, min length after cut off

L, минимальная длина после отрезания

Ø	Kısa Tasarım Short Design Краткий дизайн 4-7x Ø (mm)	Uzun Tasarım Long Design Длинный дизайн 7-10x Ø (mm)
	16	100
20	125	200
25	155	255
32	190	320
40	240	410
50	305	520
60	380	630



*konusulan
the spoken kalite...
quality...*

KARTUŞLAR

KARTUŞLAR
CARTRIDGE
КАРТРИДЖИ



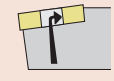
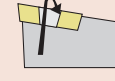

S T F C R **12 C A 16**

1 Sıkma Tipi / Method of Mounting of Insert / Способ крепления пластины

		
Deliksiz Üstten Sıkma Top Clamping Without Hole Прижим сверху без отверстия	Delikten Levye ile Sıkma Hole Clamping (Lever Lock) Прижим рычагом за отверстие	Vida ile Sıkma Screw on Крепление винтом
C	P	S



2 Uç Tipi / Type of Insert / Форма пластины

		
C	S	T

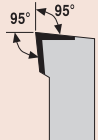
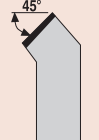
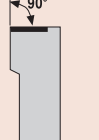
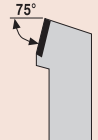
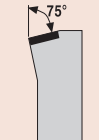
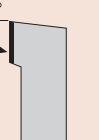
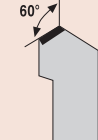
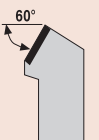
3 Yanaşma Açısı / Tool Holder Shape Bar Geometry / Угол в плане

		
L	S	F
		
R	K	G
		
W	T	

4 Serbest Uç Açısı / Insert Clearance Angle / Задний угол пластины

		
C	P	N

5 Kesme Yönü / Cutting Direction / Направление резания

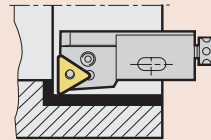
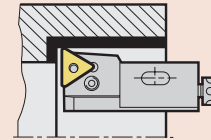
	
R	L

6 Kesme Kenar Yüksekliği / Cutting Edge Height / Высота режущей кромки

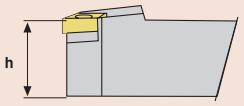

7 Kartuş Kodu / Cartridge Code / Код картриджа

C
(Kartuş / Cartridge Code / Код картриджа)

8 Kartuş Tipi / Cartridge Type / Тип картриджа

A
(ISO 5611)

9 Kesme Kenar Uzunluğu / Cutting Edge Length / Длина режущей кромки

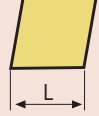
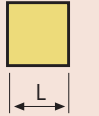
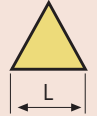
		
L	L	L

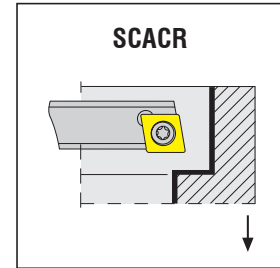
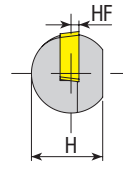
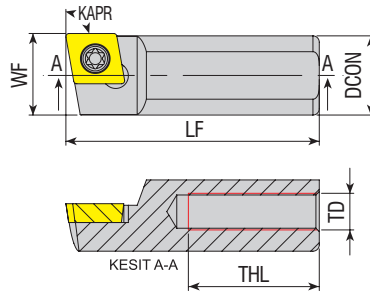

Takım Kodu
Ordering Code
Код для заказа

Stok
Stock
Наличие

Takım Ölçüleri (mm)
Dimension (mm)
Размеры (мм)

Kesici Uç
Insert
Пластина

Yedek Parçaları / Spare Parts / Запасные части

Sıkma Vidası
Screw
Зажимной винт

Tork Anahtar
Torx Key
Торх Ключ

R L

DCON

H

LF

THL

HF

WF

TD



Takım Kodu Ordering Code Код для заказа	R	L	DCON	H	LF	THL	HF	WF	TD
S10X SCACR/L 06	●	●	10	9	25	10	1	10.3	M5x0.8
S10A SCACR/L 06	●	●	10	9	32	15	1	10.3	M5x0.8
S1018 SCACR/L 06	○	●	10	9	18	8	1	9.8	M5x0.8
S1065 SCACR/L 06	○	●	10	9	65	25	1	10.3	M5x0.8
S10C SCACR/L 06	●	●	10	9	50	25	1	10.3	M5x0.8
S12B SCACR/L 06	●	●	12	11	40	25	1	12.3	M5x0.8
S12D SCACR/L 06	●	●	12	11	60	25	1	12.3	M5x0.8
S12D SCACR/L 09	●	●	12	11	60	25	2	12.2	M5x0.8
S1265 SCACR/L 09	○	●	12	11	65	25	2	12.3	M5x0.8
S12H SCACR/L 09	●	●	12	11	100	25	2	12.2	M5x0.8
S15C SCACR/L 09	●	●	15	14	50	25	2	15.3	M8x1.25
S1554 SCACR/L 09	○	●	15	14	54	25	2	15.3	M8x1.25
S15E SCACR/L 09	○	●	15	14	70	45	2	15.3	M8x1.25
S15D SCACR/L 09	○	●	15	14	60	30	2	15.3	M8x1.25
S16A SCACR/L 09	●	●	16	15	32	15	2	16.5	M6x1
S16B SCACR/L 09	●	●	16	15	40	20	2	16.5	M6x1
S16C SCACR/L 09	○	●	16	15	50	25	2	16.5	M6x1
S16D SCACR/L 09	●	●	16	15	60	30	2	16.5	M6x1
S16E SCACR/L 09	○	●	16	15	70	30	2	16.5	M6x1
S16G SCACR/L 09	●	●	16	15	90	30	2	16.5	M6x1
S16H SCACR/L 09	○	●	16	15	100	35	4	16.5	M6x1
S1868 SCACR/L 09	○	●	18	17	68	30	2	18.5	M8x1.25
S18E SCACR/L 09	●	●	18	17	70	30	2	18.5	M8x1.25
S1888 SCACR/L 09	○	●	18	17	88	30	2	18.5	M8x1.25
S18105 SCACR/L 09	○	●	18	17	105	30	2	18.5	M8x1.25
S18175 SCACR/L 09	○	●	18	17	175	30	2	18.5	M8x1.25
S20E SCACR/L 09	●	●	20	18.3	70	30	2	20.5	M6x1
S20E SCACR/L 12	●	●	20	18.3	70	30	2	20.5	M6x1
S20H SCACR/L 12	●	●	20	18.3	100	30	2	20.5	M6x1

CC.T 0602..

4008-M2.5x6

82-T08

CC.T 09T3..

4015-M3.5x8

80-T15

CC.T 1204..

1020-M5x11

80-T20

R: Sağ / Right / Правый L: Sol / Left / Левый
● Stokta / In Stock / В наличии ○ Stokta Yok / Non Stock Item / Нет в наличии

Sipariş Örneği/Ordering Example/Образец заказа
1 ad./pcs./шт. S10X SCACR 06

S-TİP REKTİFİYE KARTUŞLARI
S-TYPE RECTIFIED CARTRIDGE

ТИП-S ХОНИГОВАЛЬНЫЕ КАРТРИДЖИ (ДЛЯ РЕМОНТА ДВС)

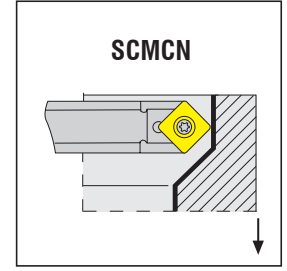
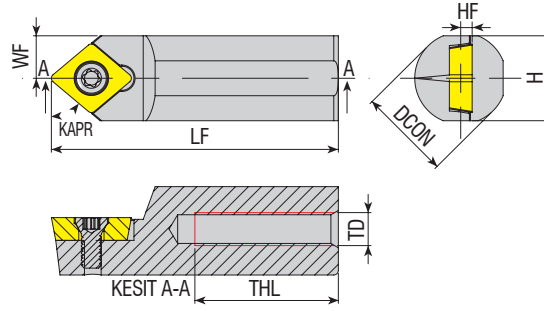

Takım Kodu Ordering Code Код для заказа	Stok Stock Наличие	Takım Ölçüleri (mm) Dimension (mm) Размеры (мм)							Kesici Uç Insert Пластина	Yedek Parçaları / Spare Parts / Запасные части	
		DCON	H	LF	THL	HF	WF	TD		Sıkma Vidası Screw Зажимной винт	Tork Anahtar Torx Key Торх Ключ
S10X SCMCN 06	●	10	9	25	10	1	5	M5x0.8			82-T08
new S10A SCMCN 06	●	10	9	32	15	1	5				
new S10B SCMCN 06	●	10	9	40	20	1	5				
new S10C SCMCN 06	●	10	9	50	25	1	5				
new S10D SCMCN 06	●	10	9	60	25	1	5				
S12D SCMCN 06	●	12	11	60	25	1	6				
S16C SCMCN 09	●	16	15	50	25	2	8	M6x1			80-T15
S16D SCMCN 09	●	16	15	60	25	4	8				

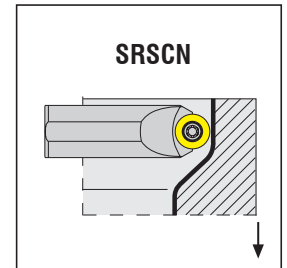
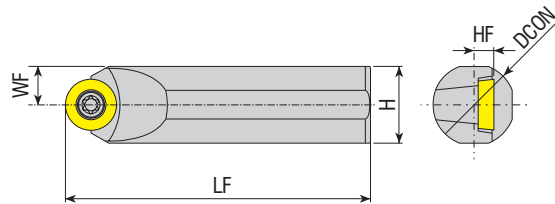

Takım Kodu Ordering Code Код для заказа	Stok Stock Наличие	Takım Ölçüleri (mm) Dimension (mm) Размеры (мм)					Kesici Uç Insert Пластина	Yedek Parçaları / Spare Parts / Запасные части	
		DCON	H	WF	HF	LF		Sıkma Vidası Screw Зажимной винт	Tork Anahtar Torx Key Торх Ключ
S12D SRSCN 10	●	12	11	6	3.9	60		4015-M3.5x9	80-T15
S14D SRSCN 10	●	14	13	7	3.9	60		4015-M3.5x11	
S16D SRSCN 10	●	16	15	8	3.9	60		4015-M3.5x11	

R: Sağ / Right / Правый L: Sol / Left / Левый

● Stokta / In Stock / В наличии ○ Stokta Yok / Non Stock Item / Нет в наличии

Sipariş Örneği/Ordering Example/Образец заказа

1 ad./pcs./шт. S10X SCMCN 06

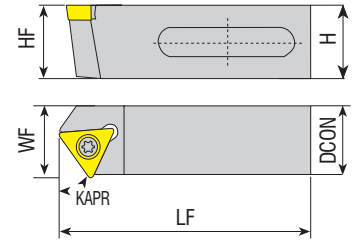

Takım Kodu Ordering Code Код для заказа	Stok Stock Наличие		Takım Ölçüleri (mm) Dimension (mm) Размеры (мм)					Kesici Uç Insert Пластина	Yedek Parçaları / Spare Parts / Запасные части		
	R	L	DCON	H	HF	LF	WF		Sıkma Vidası Screw Зажимной винт	Tork Anahtar Torx Key Торх Ключ	
STXCR/L 2020 B16	●	●	20	20	20	45	20	TC.. 16T3..			
STXCR/L 2020 E16	○	●	20	20	20	70	20				
STXCR/L 2020 B16-SA	○	●	20	10	20	45	20				
STXCR/L 2020 E16-SA	○	●	20	10	20	70	20				
STXCR/L 2020 B16-PL	○	●	20	10	20	45	20				
STXCR/L 2020 E16-PL	○	●	20	10	20	70	20				
STXCR/L 2020 H16-PL	○	●	20	10	20	100	20				

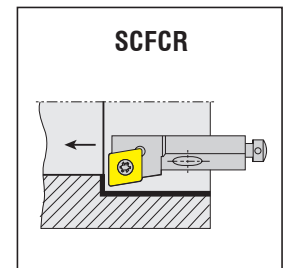
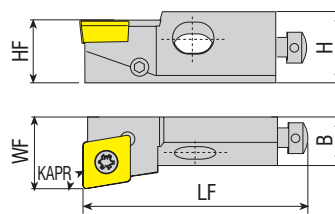
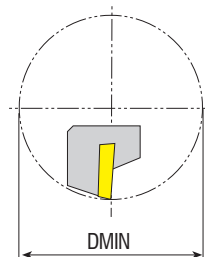

Takım Kodu Ordering Code Код для заказа	Stok Stock Наличие		Takım Ölçüleri (mm) Dimension (mm) Размеры (мм)						Kesici Uç Insert Пластина	Yedek Parçaları / Spare Parts / Запасные части			
	R	L	HF	H	B	LF	WF	DMIN		Altlık Shim Отпорная пластина	Altlık Vidası Shim Screw Винт отпорной пластины	Sıkma Vidası Screw Зажимной винт	Tork Anahtar Torx Key Торх Ключ
SCFCR/L 06CA 06	●	●	6	8.5	6	25	8	≥20	CC.T 060204	-	-	4008-M2.5x6	82-T08
SCFCR/L 08CA 06	●	●	8	11	8	32	10	≥25					
SCFCR/L 10CA 09	●	●	10	15	11	50	14	≥40					
SCFCR/L 12CA 12	●	○	12	20	15	55	20	≥50					
SCFCR/L 16CA 12	●	●	16	21	20	63	25	≥60					
									AACN-2-0003	AAV-10-M4.5x8	4020-M4.5x12	80-T20	

R: Sağ / Right / Правый L: Sol / Left / Левый
● Stokta / In Stock / В наличии ○ Stokta Yok / Non Stock Item / Нет в наличии

Sipariş Örneği/Ordering Example/Образец заказа
1 ad./pcs./шт. STXCR 2020 B16

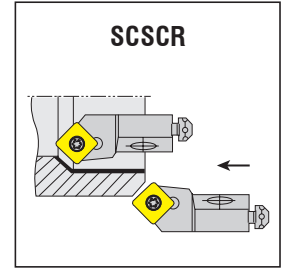
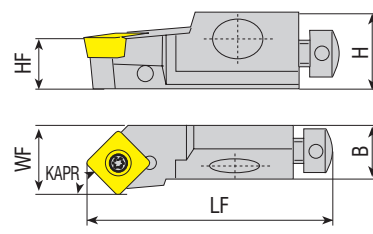
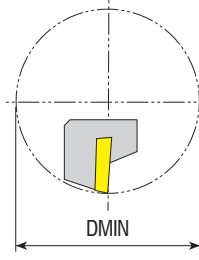

Takım Kodu Ordering Code Код для заказа	Stok Stock Наличие		Takım Ölçüleri (mm) Dimension (mm) Размеры (мм)						Kesici Uç Insert Пластина	Yedek Parçaları / Spare Parts / Запасные части			
	R	L	HF	H	B	LF	WF	DMIN		Altık Shim Опорная пластина	Altık Vidası Shim Screw Винт опорной пластины	Sıkma Vidası Screw Зажимной винт	Tork Anahtar Torx Key Торх Ключ
SCSCR/L 06CA 06	●	○	6	8	6	30	8	≥20					
SCSCR/L 10CA 09	●	○	10	15	11	50	14	≥40					
SCSCR/L 12CA 12	○	○	12	20	15	55	20	≥50					

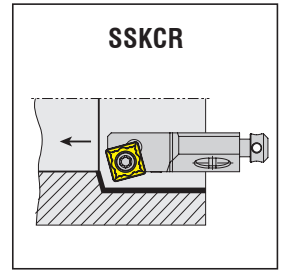
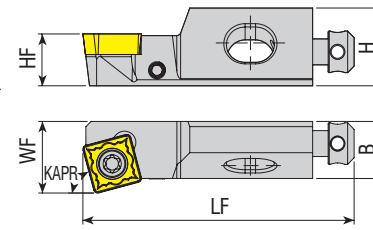
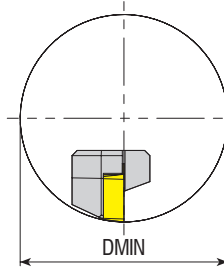

Takım Kodu Ordering Code Код для заказа	Stok Stock Наличие		Takım Ölçüleri (mm) Dimension (mm) Размеры (мм)						Kesici Uç Insert Пластина	Yedek Parçaları / Spare Parts / Запасные части			
	R	L	HF	H	B	LF	WF	DMIN		Altık Shim Опорная пластина	Altık Vidası Shim Screw Винт опорной пластины	Sıkma Vidası Screw Зажимной винт	Tork Anahtar Torx Key Торх Ключ
SSKCR/L 10CA 09	●	○	10	15	11	50	14	≥40					
SSKCR/L 12CA 12	●	○	12	20	15	55	20	≥50					

R: Sağ / Right / Правый L: Sol / Left / Левый
● Stokta / In Stock / В наличии ○ Stokta Yok / Non Stock Item / Нет в наличии

Sipariş Örneği/Ordering Example/Образец заказа
1 ad./pcs./шт. SCSCR 06CA 06

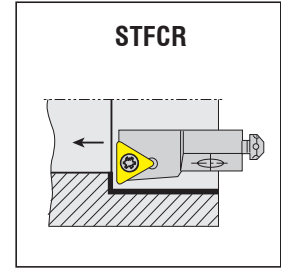
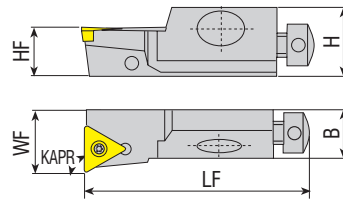
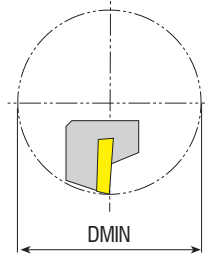

Takım Kodu
Ordering Code
Код для заказа

Stok Stock Наличие		Takım Ölçüleri (mm) Dimension (mm) Размеры (мм)							Kesici Uç Insert Пластина
R	L	HF	H	B	LF	WF	DMIN		
●	●	8	11	8	32	10	≥25		
●	●	10	15	11	50	14	≥40		
●	○	12	20	15	55	20	≥50		
●	●	16	21	20	63	25	≥60		

Yedek Parçaları / Spare Parts / Запасные части

Altlık Shim Опорная пластина	Altlık Vidası Shim Screw Винт опорной пластины	Sıkma Vidası Screw Зажимной винт	Tork Anahtar Torx Key Торх Ключ
-	-	3007-M2.2x4.6	82-T07
-	-	4008-M2.5x6	82-T08
-	-	4015-M3.5x11	80-T15
AATN-2-0001	AAV-06-M3.5x11	4015-M3.5x14	

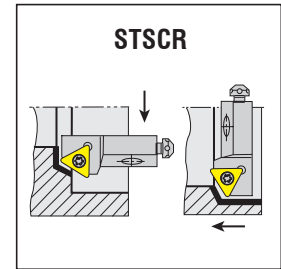
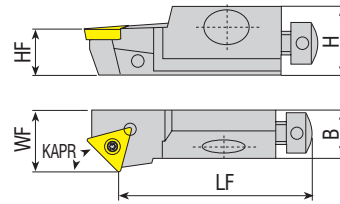
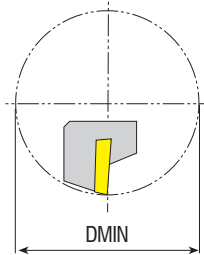

Takım Kodu
Ordering Code
Код для заказа

Stok Stock Наличие		Takım Ölçüleri (mm) Dimension (mm) Размеры (мм)							Kesici Uç Insert Пластина
R	L	HF	H	B	LF	WF	DMIN		
●	○	8	11	8	28	10	≥25		
●	●	10	15	11	44	14	≥40		
●	○	12	20	15	47	20	≥50		
●	●	16	21	20	63	25	≥60		

Yedek Parçaları / Spare Parts / Запасные части

Altlık Shim Опорная пластина	Altlık Vidası Shim Screw Винт опорной пластины	Sıkma Vidası Screw Зажимной винт	Tork Anahtar Torx Key Торх Ключ
-	-	3007-M2.2x4.6	82-T07
-	-	4008-M2.5x6	82-T08
-	-	4015-M3.5x11	80-T15

R: Sağ / Right / Правый L: Sol / Left / Левый
● Stokta / In Stock / В наличии ○ Stokta Yok / Non Stock Item / Нет в наличии

Sipariş Örneği/Ordering Example/Образец заказа
1 ad./pcs./шт. STFCR 08CA 09

➤ S-SİSTEM KARTUŞLAR
S-SYSTEM CARTRIDGE
S-ТИП КАРТРИДЖИ

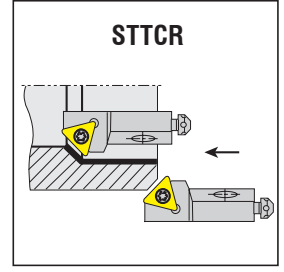
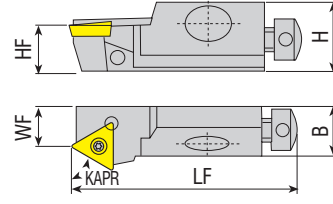
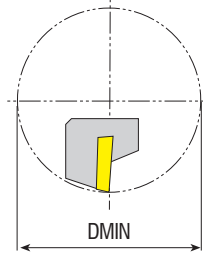

Takım Kodu Ordering Code Код для заказа	Stok Stock Наличие		Takım Ölçüleri (mm) Dimension (mm) Размеры (мм)					Kesici Uç Insert Пластина	Yedek Parçaları / Spare Parts / Запасные части				
	R	L	HF	H	B	LF	WF		DMIN	Altlık Shim Опорная пластина	Altlık Vidası Shim Screw Винт опорной пластины	Sıkma Vidası Screw Зажимной винт	Tork Anahtar Torx Key Торх Ключ
STTCR/L 08CA 09	●	●	8	11	8	32	6	≥25		-	-	3007-M2.2x4.6	82-T07
STTCR/L 10CA 11	●	●	10	15	11	50	9	≥40		-	-	4008-M2.5x6	82-T08
new STTCR/L 12CA 16	●	○	12	20	14.8	55	20	≥50		-	-	4015-M3.5x9	80-T15

➤ P-SİSTEM KARTUŞLAR
P-SYSTEM CARTRIDGE
P-ТИП КАРТРИДЖИ

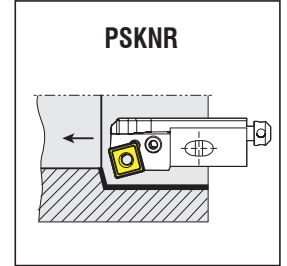
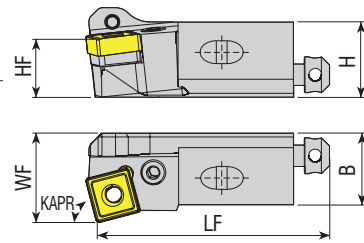
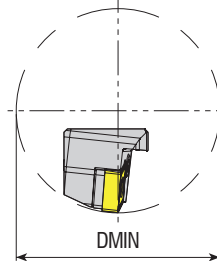

Takım Kodu Ordering Code Код для заказа	Stok Stock Наличие		Takım Ölçüleri (mm) Dimension (mm) Размеры (мм)					Kesici Uç Insert Пластина	Yedek Parçaları / Spare Parts / Запасные части					
	R	L	HF	H	B	LF	WF		DMIN	Levye Lever Рычаг	Levye Vidası Lever Screw Винт рычага	Altlık Shim Опорная пластина	Altlık Yayı Shim Spring Втулка рычага	Anahtar Allen Key Ключ
PSKNR/L 16CA 12	●	●	16	21	20	63	25	≥60		APL-02	ALV-08-M8x16	AASN-3-0004	AAY-02	AAL-02-2.5

R: Sağ / Right / Правый L: Sol / Left / Левый

● Stokta / In Stock / В наличии ○ Stokta Yok / Non Stock Item / Нет в наличии

Sipariş Örneği/Ordering Example/Образец заказа

1 ad./pcs./шт. STTCR 08CA 09

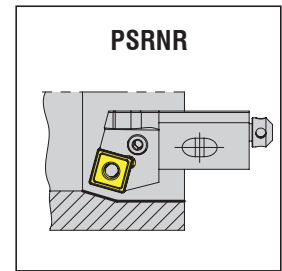
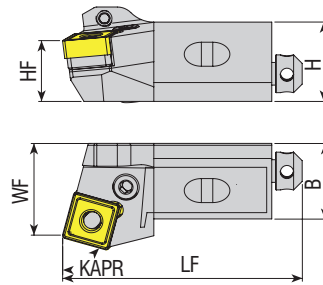
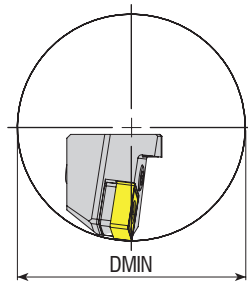

Takım Kodu Ordering Code Код для заказа	Stok Stock Наличие		Takım Ölçüleri (mm) Dimension (mm) Размеры (мм)					Kesici Uç Insert Пластина	Yedek Parçaları / Spare Parts / Запасные части					
	R	L	HF	H	B	LF	WF		DMIN	Levyeye Lever Рычаг	Levyeye Vidası Lever Screw Винт рычага	Altılık Shim Опорная пластина	Altılık Yayısı Shim Spring Втулка рычага	Anahtar Allen Key Ключ
PSNR/L 16CA 12	○	●	16	21	20	63	25	≥60						

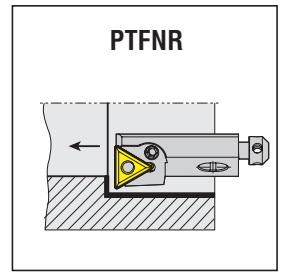
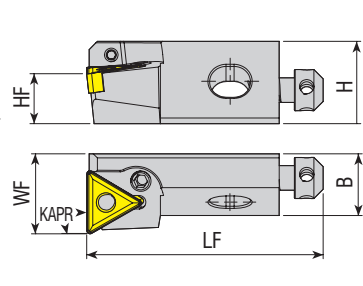
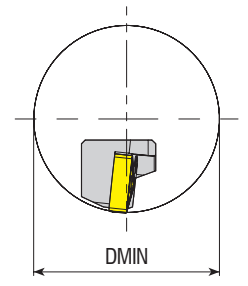

Takım Kodu Ordering Code Код для заказа	Stok Stock Наличие		Takım Ölçüleri (mm) Dimension (mm) Размеры (мм)					Kesici Uç Insert Пластина	Yedek Parçaları / Spare Parts / Запасные части					
	R	L	HF	H	B	LF	WF		DMIN	Levyeye Lever Рычаг	Levyeye Vidası Lever Screw Винт рычага	Altılık Shim Опорная пластина	Altılık Yayısı Shim Spring Втулка рычага	Anahtar Allen Key Ключ
PTFNR/L 12CA 16	●	●	12	20	15	47	20	≥50				-		
PTFNR/L 16CA 16	●	○	16	21	20	63	25	≥60	TNM.160408					
new PTFNR/L 16CA 22	○	●	16	21	20	63	25	≥60	TNMG 2204.					
new PTFNR/L 20CA 22	●	○	20	30	20	63	25	≥70	TNMG 2204.					

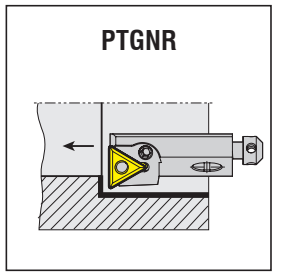
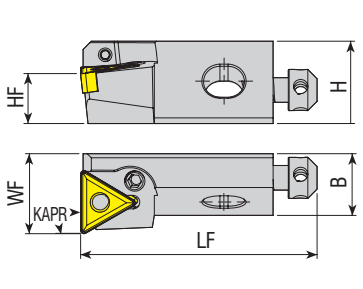
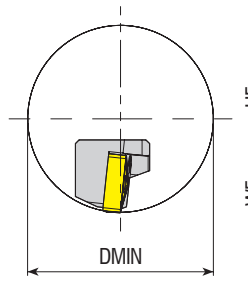

Takım Kodu Ordering Code Код для заказа	Stok Stock Наличие		Takım Ölçüleri (mm) Dimension (mm) Размеры (мм)					Kesici Uç Insert Пластина	Yedek Parçaları / Spare Parts / Запасные части					
	R	L	HF	H	B	LF	WF		DMIN	Levyeye Lever Рычаг	Levyeye Vidası Lever Screw Винт рычага	Altılık Shim Опорная пластина	Altılık Yayısı Shim Spring Втулка рычага	Anahtar Allen Key Ключ
PTGNR/L 16CA 22	●	●	16	21	20	63	25	60	TNMG 2204..					

R: Sağ / Right / Правый L: Sol / Left / Левый
● Stokta / In Stock / В наличии ○ Stokta Yok / Non Stock Item / Нет в наличии

Sipariş Örneği/Ordering Example/Образец заказа
1 ad./pcs./шт. PSNR 16CA 12



KAPR = 45°

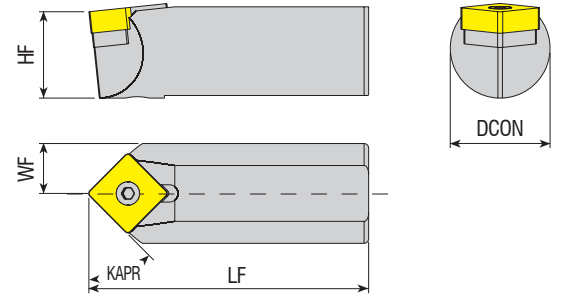

Takım Kodu Ordering Code Код для заказа	Stok Stock Наличие	Takım Ölçüleri (mm) Dimension (mm) Размеры (мм)				Kesici Uç Insert Пластина	Yedek Parçaları / Spare Parts / Запасные части				
		DCON	HF	LF	WF		Aitlik Shim Опорная пластина	Sıkma Vidası Screw Зажимной винт	Baskı Parçası Wedge Clamp Прижим	Baskı Vidası Clamp Screw Зажимной винт	Tork Anahtar Torx Key Торк Ключ
S22D PSDNN 12C	●	22	17.5	65	11						
						SNM. 1204..	AASN-20020	AEV-01-M6x16	ACK-05	4015-M4x11	AAL-02-2.5

R: Sağ / Right / Правый L: Sol / Left / Левый
● Stokta / In Stock / В наличии ○ Stokta Yok / Non Stock Item / Нет в наличии

Sipariş Örneği/Ordering Example/Образец заказа
1 ad./pcs./шт. S22D PSDNN 12C

KARTUŞLARIN YEDEK PARÇALARI
SPARE PARTS OF CARTRIDGE
ЗАПАСНЫЕ ЧАСТИ К КАРТРИДЖАМ

Takım Kodu Ordering Code Код для заказа	Yedek Parçaları / Spare Parts / Запасные части					
	Eksenel Ayar Vida Axial Adj. Screw Осевой регулировочный винт	Radyal Ayar Vida Radial Adj. Screw Радиальный регулировочный винт	Radyal Ayar Vida Anahtar Radial Adj. Screw Allen Key Шестигранный ключ для крепления радиального винта	Montaj Vida Mounting Screw Монтажный винт	Montaj Vida Anahtar Mounting Screw Allen Key Монтажный винт с головкой под шестигранник	
SCFCR/L	06CA 06	2600-M4x9.5	2715-M3x5	AAL-09-1.5	AKV-23-M4x10	AAL-03-3
SCSCR/L	08CA 06	2600-M4x9.5	2715-M3x5	AAL-09-1.5	AKV-23-M4x10	AAL-03-3
SSKCR/L	10CA 09	2600-M5x13	2702-M4x10	AAL-01-2	2505-M6x16	AAL-03-3
	12CA 12	2600-M5x13	2702-M4x10	AAL-01-2	2505-M6x16	AAL-03-3
	16CA 12	2600-M6x18	2725-M5x12	AAL-02-2.5	2005-M8x25	AAL-07-5
STSCR/L	08CA 09	2600-M4x9.5	2715-M3x5	AAL-09-1.5	AKV-23-M4x10	AAL-03-3
STTCR/L	10CA 11	2600-M5x13	2702-M4x10	AAL-01-2	2505-M6x16	AAL-03-3
STFCR/L	12CA 16	2600-M5x13	2702-M4x10	AAL-01-2	2505-M6x16	AAL-03-3
	16CA 16	2600-M6x18	2725-M5x12	AAL-02-2.5	2005-M8x25	AAL-07-5
PTFNR/L	12CA 16	2600-M5x13	2702-M4x4	AAL-01-2	2505-M6x16	AAL-03-3
PSKNR/L	16CA 16	2600-M6x18	2725-M5x6	AAL-02-2.5	2005-M8x25	AAL-07-5
PSRNR/L	16CA 12	2600-M6x18	2725-M5x6	AAL-02-2.5	2005-M8x25	AAL-07-5



Takım Kodu Ordering Code Код для заказа	Stok Stock Наличие	Ölçü Aralığı (mm) Boring Range (mm) Диапазон растачивание (мм)					Kartuşlar Cartridge Картриджи	Gövde Takım Kodu Body Tool Code Код головки	Teknik Çizim Technical Draw Технический эскиз
		D max		D min		Max (D dış-D iç) (D out-D in)			
		D iç D in	D dış D out	D iç D in	D dış D out				
ACPBT-1	●	27-52	52	18-36	36	27	ÖTG-K-120-20		
ACPBT-2	●	27-49	52	25-36	36	27			
ACPBT-3	●	48-75	75	41	42	27			
ACPBT-4	●	51-75	75	51	52	27			
ACPBT-5	●	22-35	35	22	23	27			
ACPBT-6	●	15-35	35	15	16	27			
ACPBT-7	●	49-53	75	32-36	36	27			
ACPBT-8	●	49	75	33-37	37	27			

Takım Kodu Ordering Code Код для заказа	Stok Stock Наличие	Ölçü Aralığı (mm) Boring Range (mm) Диапазон растачивание (мм)					Kartuşlar Cartridge Картриджи	Gövde Takım Kodu Body Tool Code Код головки	Teknik Çizim Technical Draw Технический эскиз
		D1		D2		Max (D dış-D iç) (D out-D in)			
		D max	D min	D max	D min				
ACPBT-9	●	38	24	15	1	-	ÖTG-K-120-20		
ACPBT-10	●	78	64	43	29	-			

R: Sağ / Right / Правый L: Sol / Left / Левый

● Stokta / In Stock / В наличии ○ Stokta Yok / Non Stock Item / Нет в наличии

Sipariş Örneği / Ordering Example / Образец заказа

1 ad./pcs./шт. ACPBT-1



*konusulan
the spoken kalite...
quality...*

DİŞ AÇMA

DİŞ AÇMA TAKIMLARI
THREADING TOOLHOLDERS
РЕЗЬБОНАРЕЗНЫЕ ДЕРЖАВКИ





S **E** **R** **25 25** **M** **16** **C**

1 Sıkma Tipi / Method of Mounting of Insert
 Тип крепления пластины угла наклона пластины

S: Vida Sıkmalı
 S: Screw Clamping / S Крепление винтом
 T: Vida Sıkmalı Helis Açılı
 T: Screw Clamping with Helix Angle
 T: Крепление винтом с углом наклона винтовой линии

2 İşlem Tipi / Application
 Применение

E: Diş / External
 Нарезание для наружной резьбы
 I: İç / Internal /
 Для наружной резьбы

3 Kesme Yönü
 Cutting Direction
 Направление резания

R: Sağ Yan
 Right-Hand
 R: Правый
 L: Sol Yan
 Left-Hand
 L: Левый

4 Takım Malzemesi / Type of Boring / Сталь Инструмена

"A" Yekpare çelik gövde soğutma suyu kanallı / "A" Solid steel with coolant hole
 "A" Расточная державка из твердой стали с подвожом СОЖ
 "E" Çelik başlıkla sert metal gövde ve soğutma suyu kanallı / "E" Carbide bar with fixed steel head and coolant hole
 "E" Расточная державка из твердосплавного карбида с подвожом СОЖ
 "C" Karbür Şaft / "C" Carbide shank / "C" Расточная державка из твердосплавного карбида
 "S" Çelik Şaft / "S" Steel shank / "S" Расточная державка из твердой стали

4-5 Diş Çap Şaft Ölçüleri / External Shank Size
 Сечение державки

Şaft / Shank / Размеры : hxb
 2525 - 25 x 25 mm

5 Şaft Çapı / Shank Diameter
 Диаметр хвостовика

6 Şaft Boyu / Shank Length / Длина державки

A - 32	H - 100	Q - 180	x-special
B - 40	J - 110	R - 200	
C - 50	K - 125	S - 250	
D - 60	L - 140	T - 300	
E - 70	M - 150	U - 350	
F - 80	N - 160	V - 400	
G - 90	P - 170	W - 450	

7 Elmas Ölçüsü / Insert Size
 Размер пластины

l (mm)	d
06	5/32"
08	3/16"
11	1/4"
16	3/8"
22	1/2"
27	5/8"

8 Baskı Pabucu
 Wedge Clamp
 Прижим

S **I** **R** **S** **25** **R** **16** **C**

DIŞ ÇAP DIŞ AÇMA KATERLERİ
EXTERNAL THREADING TOOLHOLDERS
ДЕРЖАВКА ДЛЯ НАРЕЗАНИЯ НАРУЖНОЙ РЕЗЬБЫ

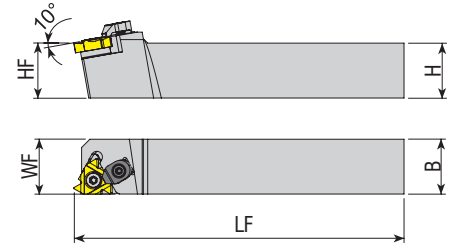
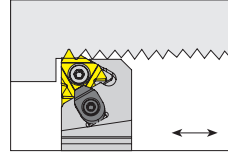

Takım Kodu
Ordering Code
Код для заказа

Stok Stock Наличие	Takım Ölçüleri (mm) Dimension (mm) Размеры (мм)						Kesici Uç Insert Пластина	Yedek Parçaları / Spare Parts / Запасные части					
	R	L	HF=H	B	LF	WF		Sıkma Vidası Screw Зажимной винт	Aitlik Shim Опорная пластина	Aitlik Vidası Shim Screw Винт опорной пластины	Baskı Parçası Wedge Clamp Прижим	Baskı Vidası Clamp Screw Зажимной винт	Tork Anahtar Torx Key Торх Ключ
● ●			08	08	70	11	11 ER/EL	4008-M2.5x6	-	-	-	-	82-T08
● ●			10	10	70	11							
● ●			12	12	80	12							
● ●			16	16	100	16							
● ●			20	20	100	20	16 ER/EL (0.35 - 3) ISO METRIC	4015-M3.5x14	AATN-2-0020	AAV-06-M3.5x11	-	-	80-T15
● ●			16	16	100	16							
● ●			20	20	125	20							
● ●			25	25	150	25							
● ●			32	32	170	32	22 ER/EL (3.5 - 4.5) ISO METRIC	1020-M4.5x16	AATN-2-0004	AAV-07-M4.5x13	ACK-05	4015 M4x11	80-T20
● ●			25	25	150	25							
● ●			32	32	170	32							
● ●			40	40	250	40							
● ●			25	25	150	25	16 ER/L (1.5-3 TR)	4015-M3.5x14	-	-	-	-	80-T15
● ●			25	25	150	25	22 ER/L (4-6 TR)	1020-M4.5x16	-	-	-	-	80-T20
● ●			20	20	125	25	SNDVK 166 ER/L16	4015-M3.5x14	AATN-2-0020	AAV-06-M3.5x11	-	-	80-T15
● ●			25	25	150	31							
● ●			32	32	170	38.5							

DIŞ ÇAP DIŞ AÇMA İSVİÇRE TİPİ KAYAR OTOMAT MAKİNA KATERLERİ
EXTERNAL THREADING TOOLHOLDERS FOR SWISS TYPE SLIDING AUTOMATIC LATHES
ДЕРЖАВКА ДЛЯ НАРЕЗАНИЯ НАРУЖНОЙ РЕЗЬБЫ ДЛЯ СТАНКОВ-АВТОМАТОВ ШВЕЙЦАРСКОГО ТИПА

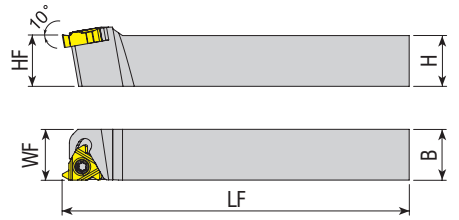
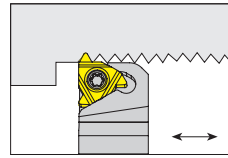

Takım Kodu
Ordering Code
Код для заказа

Stok Stock Наличие	Takım Ölçüleri (mm) Dimension (mm) Размеры (мм)						Kesici Uç Insert Пластина	Yedek Parçaları / Spare Parts / Запасные части					
	R	L	HF=H	B	LF	WF		Sıkma Vidası Screw Зажимной винт	Aitlik Shim Опорная пластина	Aitlik Vidası Shim Screw Винт опорной пластины	Baskı Parçası Wedge Clamp Прижим	Baskı Vidası Clamp Screw Зажимной винт	Tork Anahtar Torx Key Торх Ключ
● ●			10	10	125	10	11 ER/EL	4008-M2.5x6	-	-	-	-	82-T08
● ●			12	12	125	12							
● ●			12	12	125	12							
● ●			12	12	125	12	16 ER/EL (0.35 - 3)	4015-M3.5x14	AATN-2-0020	AAV-08-M3.5x8	-	-	80-T15

R: Sağ / Right / Правый L: Sol / Left / Левый ● Stokta / In Stock / В наличии ○ Stokta Yok / Non Stock Item / Нет в наличии
 Takımlar standart 1.5° helis açılı olarak üretilir. / The tools have a built in 1.5° helix angle. / Стандартные опорные пластины имеют угол наклона 1.5°
 UYARI / WARNING / ПРЕДУПРЕЖДЕНИЕ: Sayfa 114'deki B ve D değerleri uygulanamaz. / The operation for B and D on page 114 can not be applied. / Операции для B и D на стр. 114 не применяются

Sipariş Örneği/Ordering Example/Образец заказа
 1 ad./pcs./шт. SER 0808 E11



www.akko.com.tr

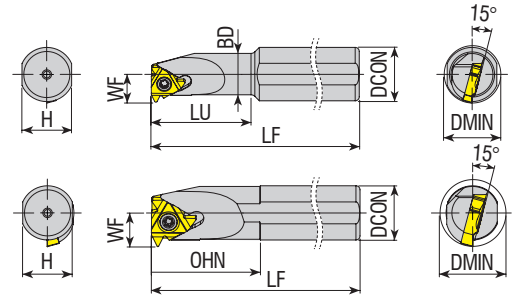
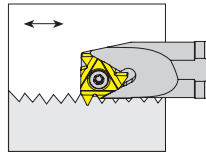

Takım Kodu
Ordering Code
Код для заказа

Takım Kodu Ordering Code Код для заказа	Stok Stock Наличие		Takım Ölçüleri (mm) Dimension (mm) Размеры (мм)						Kesici Uç Insert Пластина	Yedek Parçaları / Spare Parts / Запасные части					
	R	L	DCON	BD	LF	LU=OHN	WF	DMIN		Sıkma Vidası Screw Зажимной винт	Ahtlık Shim Опорная пластина	Ahtlık Vidası Shim Screw Винт опорной пластины	Baskı Parçası Wedge Clamp Прижим	Baskı Vidası Clamp Screw Зажимной винт	Tork Anahtar Torx Key Торх Ключ
SIR/L S12X05H 06	●	○	12	05	100	15	4.3	6.4	06 IR/L	3006-M2X3.6	-	-	-	-	82-T06
SIR/L S16X05H 06	○	●	16	05	100	15	4.3	6.4							
SIR/L S16X07M 08	●	●	16	07	150	18	5.3	7.8							
SIR/L S10H 11	●	●	10	10	100	-	7.4	12	11 IR/L	4008-M2.5x6	-	-	-	-	82-T08
SIR/L S12K 11	●	●	12	12	125	-	8.4	15							
SIR/L S16X10M 11	●	●	16	10	150	25	7.4	12							
SIR/L S16X13M 11	●	●	16	13	150	32	8.9	15							
SIR/L S16M 11	●	●	16	16	150	-	11.7	19							
new SIR/L A16X13M 16	●	●	16	12.8	150	32	9.05	16	16 IR/L (0.35 - 3) ISO METRIC	4015-M3.5x9	-	-	-	-	80-T15
SIR/L S16X13M 16	●	●	16	13	150	32	10.2	16							
SIR/L S16M 16	●	●	16	16	150	-	11.7	19							
SIR/L S20X16P 16	●	●	20	16	170	40	11.7	19							
new SIR/L A20X16P 16	●	●	20	16	170	40	11.7	19							
SIR/L S20P 16	●	●	20	20	170	-	13.7	24							
SIR/L S25R 16C	●	●	25	25	200	-	16.2	29							
SIR/L S32S 16C	●	●	32	32	250	-	19.7	36							
SIR/L S40T 16C	●	●	40	40	300	-	23.7	44							
SIR/L S50U 16C	●	●	50	50	350	-	28.7	54							
SIR/L S20P 22	●	●	20	20	170	-	15.7	24	22 IR/L (3.5 - 4.5) ISO METRIC	4020-M4.5x12	-	-	-	-	80-T20
SIR/L S25R 22C	●	●	25	25	200	-	18.1	29							
SIR/L S32S 22C	●	●	32	32	250	-	21.6	38							
SIR/L S40T 22C	●	●	40	40	300	-	25.6	46							
SIR/L S50U 22C	●	●	50	50	350	-	30.6	58							
SIR/L S25R 16C-T	●	●	25	25	200	-	16.2	29	16 IR/L (1.5-3 TR)	4015-M3.5x14	-	-	-	-	80-T15
SIR/L S32S 16C-T	●	●	32	32	250	-	19.7	36							
SIR/L S25R 22C-T	●	●	25	25	200	-	18.1	29	22 IR/L (4-6 TR)	1020-M4.5x16	-	-	-	-	80-T20
SIR/L S32S 22C-T	●	●	32	32	250	-	21.6	38							

R: Sağ / Right / Правый L: Sol / Left / Левый ● Stokta / In Stock / В наличии ○ Stokta Yok / Non Stock Item / Нет в наличии
Takımlar standart 1.5° helis açılı olarak üretilir. / The tools have a built in 1.5° helix angle. / Стандартные опорные пластины имеют угол наклона 1.5°
UYARI / WARNING / ПРЕДУПРЕЖДЕНИЕ: Sayfa 115'deki B ve D figürleri uygulanamaz. / The operation for B and D on page 115 can not be applied. / Операции для B и D на стр. 115 не применяется

Sipariş Örneği/Ordering Example/Образец заказа
1 ad./pcs./шт. SIR S12X05H 06

DIŞ ÇAP DIŞ AÇMA KATERLERİ
EXTERNAL THREADING TOOLHOLDERS
ДЕРЖАВКА ДЛЯ НАРЕЗАНИЯ НАРУЖНОЙ РЕЗЬБЫ С РЕГУЛИРОВКОЙ УГЛА НАКЛОНА РЕЖУЩЕЙ ПЛАСТИНЫ

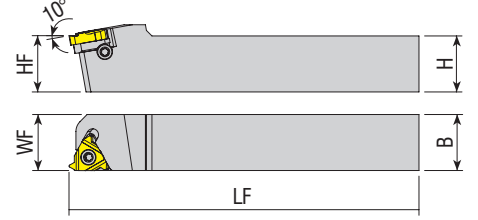
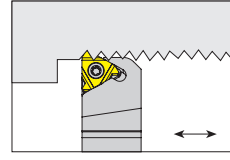
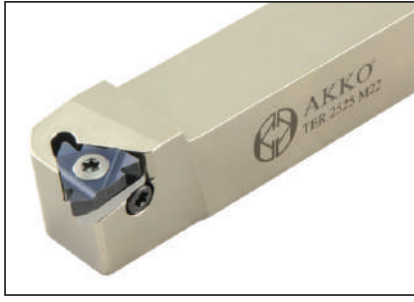

Takım Kodu Ordering Code Код для заказа	Stok Stock Наличие		Takım Ölçüleri (mm) Dimension (mm) Размеры (мм)				Kesici Uç Insert Пластина	Yedek Parçaları / Spare Parts / Запасные части					
	R	L	HF=H	B	LF	WF		Sikma Vidası Screw Зажимной винт	Sağ Altlık Right Shim U-Plate for WSP-plates	Sol Altlık Left Shim U-Plate for WSP-plates	Altık Vidası Shim Screw Винт опорной пластины	Altık Vidası Pulu Shim Screw Ring Винт опорной пластины/пту	Tork Anahtar Torx Key Торх Ключ
TER/L 1616 H16	●	●	16	16	100	16	16 ER/EL						
TER/L 2020 K16	●	●	20	20	125	20							
TER/L 2525 M16	●	●	25	25	150	25							
TER/L 3232 P16	●	●	32	32	170	32	22 ER/EL						
TER/L 2525 M22	●	●	25	25	150	25							
TER/L 3232 P22	●	●	32	32	170	32							
TER/L 4040 S22	●	●	40	40	250	40	27 ER/EL						
TER/L 2525 M27	●	●	25	25	150	25							
TER/L 3232 P27	●	●	32	32	170	32							
TER/L 4040 S27	●	●	40	40	250	40							

R: Sağ / Right / Правый L: Sol / Left / Левый ● Stokta / In Stock / В наличии ○ Stokta Yok / Non Stock Item / Нет в наличии

Sipariş Örneği/Ordering Example/Образец заказа

Takımlar standart 1.5° helis açılı olarak üretilir. / The tools have a built in 1.5° helix angle. / Стандартные опорные пластины имеют угол наклона 1.5°

1 ad./pcs./шт. TER 1616 H16

DIŞ ÇAP SAĞ YÖNDE VİDA AÇMA
EXTERNAL RIGHT HAND THREADING OPERATION
НАРЕЗАНИЕ ПРАВОЙ НАРУЖНОЙ РЕЗЬБЫ

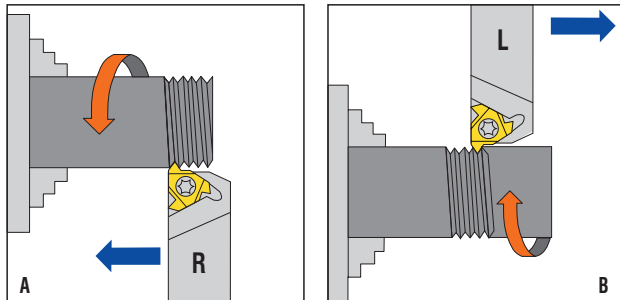

DIŞ ÇAP SOL YÖNDE VİDA AÇMA
EXTERNAL LEFT HAND THREADING OPERATION
НАРЕЗАНИЕ ЛЕВОЙ НАРУЖНОЙ РЕЗЬБЫ

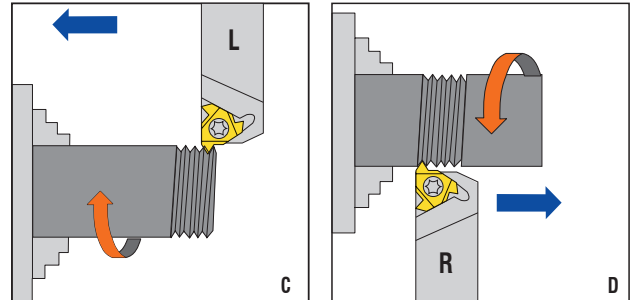

UYARI / WARNING / ВНИМАНИЕ

Figür B ve D için; negatif açılı altlık kullanılmalıdır. / For figure B and D; negative shim must be used. / Для схем B и D необходимо использовать отрицательную подложку под резьбовую пластину.
 Altıksız katerlerde B ve D figürü uygulanamaz. / B and D figures can not be applied on tools without shim. / Схемы B и D нельзя применять без подкладки под резьбовую пластину.



www.akko.com.tr

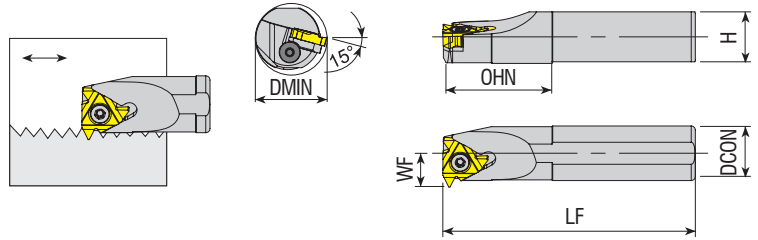

Takım Kodu Ordering Code Код для заказа	Stok Stock Наличие		Takım Ölçüleri (mm) Dimension (mm) Размеры (мм)					Kesici Uç Insert Пластина	Yedek Parçaları / Spare Parts / Запасные части						
	R	L	DCON	H	LF	OHN	WF		DMIN	Sıkma Vidası Screw Зажимной винт	Sol Aitlik Left Shim U-Platte für WSP links	Sağ Aitlik Right Shim U-Platte für WSP rechts	Aitlik Vidası Shim Screw Винт опорной пластины	Aitlik Vidası Pulu Shim Screw Ring Винт опорной пластины/палу	Tork Anahtar Torx Key Торх Ключ
TIR/L S25R 16	●	●	25	23	200	-	16.2	29	16 IR/L	1710-U5-40x12.2	ATS-16E	ATS-16I	AAV-11-U5-40x4.5	ABPL-03	82-T10
TIR/L S32S 16	●	●	32	30	250	-	19.7	36							
TIR/L S40T 16	●	●	40	37.5	300	-	23.7	44							
TIR/L S50U 16	●	●	50	47	350	-	28.7	54							
TIR/L S25R 22	●	●	25	23	200	-	18.1	29	22 IR/L	1720-U8-32x15	ATS-22E	ATS-22I	AAV-12-U8-32x5.5	ABPL-04	80-T20
TIR/L S32S 22	●	●	32	30	250	-	21.6	38							
TIR/L S40T 22	●	●	40	37.5	300	-	25.6	46							
TIR/L S50U 22	●	●	50	47	350	-	30.6	58							
TIR/L S32S 27	●	●	32	30	250	-	22.6	40	27 IR/L	1620-M5x18	ATS-27E	ATS-27I	AAV-15-M5x5.7	ABPL-05	80-T20
TIR/L S40T 27	●	●	40	37.5	300	-	26.6	48		1620-M5x22					
TIR/L S50U 27	●	●	50	47	350	-	31.6	58							
new TIR/L A20P 16	●	○	20	13.7	170	40	18	24	16 IR/L	1710-U5-40x12.2	ATS-16E	ATS-16I	AAV-11-U5-40x4.5	ABPL-03	82-T10
TIR/L A25R 16	○	●	25	23	200	50	16.2	29							
TIR/L A32S 16	○	●	32	30	250	60	19.7	36							
TIR/L A40T 16	○	●	40	37.5	300	65	23.9	44							

R: Sağ / Right / Правый L: Sol / Left / Левый ● Stokta / In Stock / В наличии ○ Stokta Yok / Non Stock Item / Нет в наличии
Takımlar standart 1.5° helis açılı olarak üretilir. / The tools have a built in 1.5° helix angle. / Стандартные опорные пластины имеют угол наклона 1.5°

Sipariş Örneği/Ordering Example/Образец заказа
1 ad./pcs./шт. TIR S25R 16

DELİK İÇİ SAĞ YÖNDE VİDA AÇMA
INTERNAL RIGHT HAND THREADING OPERATION
НАРЕЗАНИЕ ПРАВОЙ НАРУЖНОЙ РЕЗЬБЫ

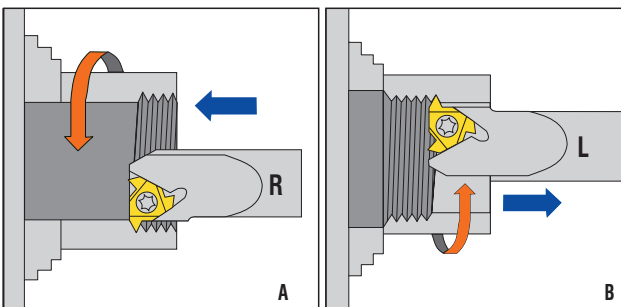

DELİK İÇİ SOL YÖNDE VİDA AÇMA
INTERNAL LEFT HAND THREADING OPERATION
НАРЕЗАНИЕ ЛЕВОЙ НАРУЖНОЙ РЕЗЬБЫ

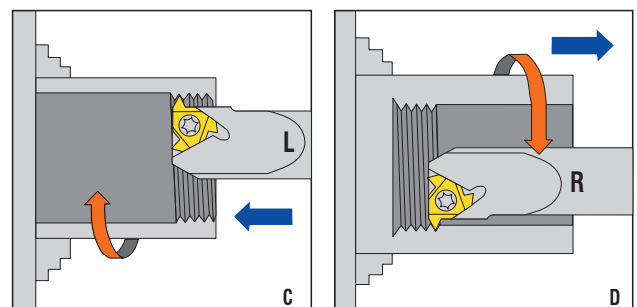

UYARI / WARNING / ВНИМАНИЕ

Figür B ve D için; negatif açılı altlık kullanılmalıdır. / For figure B and D; negative shim must be used. / Für Abbildung B und D; negative Unterlage verwenden.
Aitliksiz katerlerde B ve D figürü uygulanamaz. / B and D figures can not be applied on tools without shim. / Схемы B и D нельзя применять без подкладки под резьбовую пластину

Diş Helis Açısı Thread Helix Angle Угол подъема резьбы

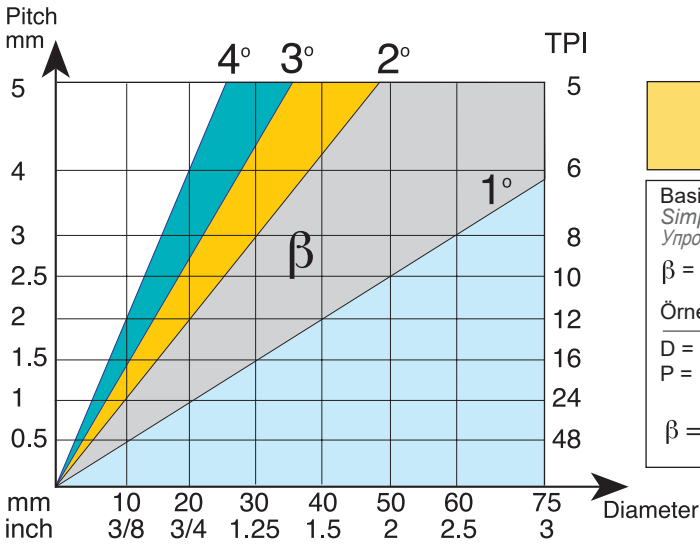

$$\tan \beta = \frac{P}{\pi \times D}$$

Basitleştirilmiş formül
 Simplified formula
 Упрощенная формула
 $\beta = 20 P/D$

Örnek / Example / Пример:
 $D = 25 \text{ mm (0.98")}$
 $P = 1.5 \text{ mm (16 TPI)}$
 $\beta = \frac{20 \times 1.5}{25} = 1.2^\circ$

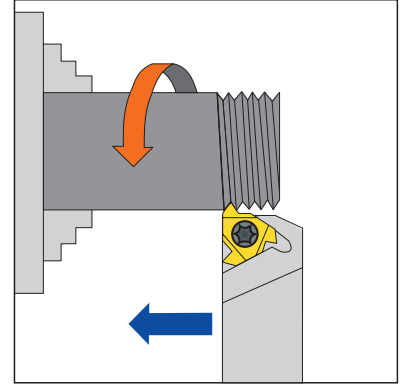

Standart ve Eğik Altlıklar Standard and Slanted Shim Стандартная и наклонная опорная пластина

Akko diş açma takımlarının, uç yuvaları 1.5° helis açılı olarak üretilir. Farklı helis açılı diş açmak isteyenler altlığı değiştirerek istedikleri dereceyi elde edebilirler. Negatif helis genellikle sol katerde sağ diş çekmek için kullanılır ya da sağ katerde sol diş çekmek için kullanılır.

Akko Toolholders Pockets have a built in 1.5° helix angle. This angle may be adjusted to better match the thread helix angle by simply changing the shim. Negative helix is usually used when threading RH thread with LH Holder or LH thread with RH Holder.

Державки АККО имеют стандартный угол наклона опорной пластины 1,5°. Этот угол можно отрегулировать путем замены опорной пластины. Отрицательный угол наклона обычно используется когда правая резьба RH нарезается левой державкой LH или левая резьба LH нарезается правой державкой RH.

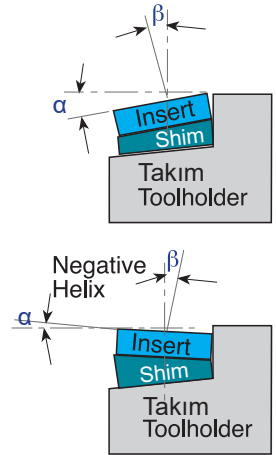

L	IC	Takım Tipi Tool Type Тип Инструмента	Uç Yuvasının Açısı (α) / Pocket's Angle (α) / Угол наклона (α)						
			4.5°	3.5°	2.5°	1.5°	0.5°	-0.5°	-1.5°
16	3/8	EX-RH or IN-LH	ATS-16E+4.5	ATS-16E+3.5	ATS-16E+2.5	ATS-16E	ATS-16E+0.5	ATS-16E-0.5	ATS-16E-1.5
16	3/8	EX-LH or IN-RH	ATS-16I+4.5	ATS-16I+3.5	ATS-16I+2.5	ATS-16I	ATS-16I+0.5	ATS-16I-0.5	ATS-16I-1.5
22	1/2	EX-RH or IN-LH	ATS-22E+4.5	ATS-22E+3.5	ATS-22E+2.5	ATS-22E	ATS-22E+0.5	ATS-22E-0.5	ATS-22E-1.5
22	1/2	EX-LH or IN-RH	ATS-22I+4.5	ATS-22I+3.5	ATS-22I+2.5	ATS-22I	ATS-22I+0.5	ATS-22I-0.5	ATS-22I-1.5
27	5/8	EX-RH or IN-LH	ATS-27E+4.5	ATS-27E+3.5	ATS-27E+2.5	ATS-27E	ATS-27E+0.5	ATS-27E-0.5	ATS-27E-1.5
27	5/8	EX-LH or IN-RH	ATS-27I+4.5	ATS-27I+3.5	ATS-27I+2.5	ATS-27I	ATS-27I+0.5	ATS-27I-0.5	ATS-27I-1.5

Altlık Değişirme Öneri Tablosu / Shim Change Recommendation Рекомендации по смене опорной пластины

Tabloda da görüldüğü gibi bazı diş hatvelerinin çaplara göre kombinasyonları altlık değişimini gerektirir. Eğer değişim gerekli ise EX-RH ve IN-LH katerleri için ATS-E altlıklarını, IN-RH ve EX-LH katerleri için ATS-I altlıklarını kullanın.
 As can be seen from the chart, some Pitch to Diameter combinations require a shim change. If change is required, use ATS-E shim for EX-RH and IN-LH toolholders and ATS-I shims for IN-RH and EX-LH toolholders.

Как видно из диаграммы, некоторые комбинации Шаг на Диаметр требуют замены опорной пластины. Если требуется замена, используйте опорные пластины ATS-E для державок инструментов EX-RH и IN-LH и опорные пластины ATS-I для державок IN-RH и EX-LH.

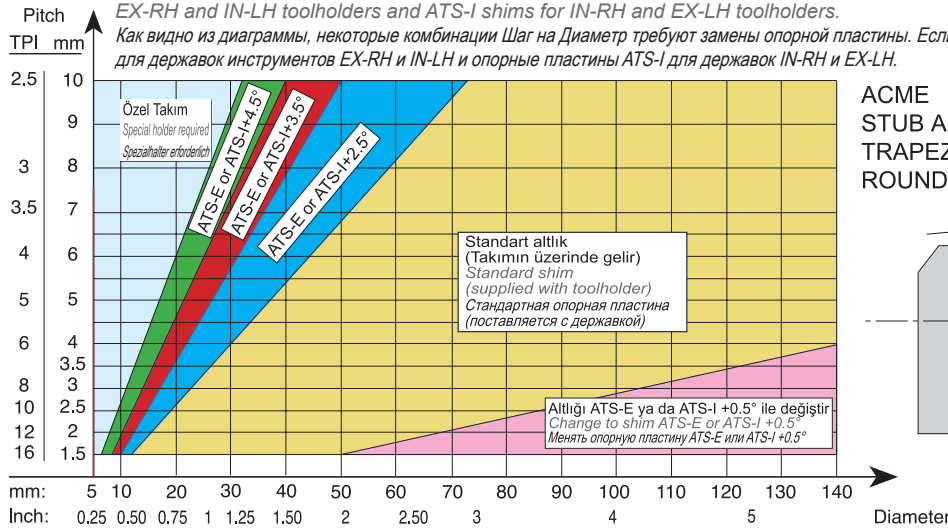

ACME
 STUB ACME
 TRAPEZ (DIN 103)
 ROUND (DIN 405)

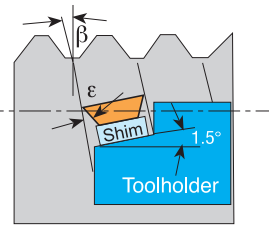

Tabloda da görüldüğü gibi çoğu uygulamalar altlık değişimine ihtiyaç duymaz. Eğer değişime ihtiyaç duyulursa EX-RH ve IN-LH katerleri için ATS-E altlıklarını, IN-RH ve EX-RH katerleri için ATS-I altlıklarını kullanın.

As can be seen from the chart, most applications do not require a shim change. If change is required, use ATS-E shims for EX-RH and IN-LH toolholders and ATS-I shims for IN-RH and EX-LH toolholders.

Как видно из диаграммы, некоторые комбинации Шаг на Диаметр требуют замены опорной пластины. Если требуется замена, используйте опорные пластины ATS-E для державок инструментов EX-RH и IN-LH и опорные пластины ATS-I для державок IN-RH и EX-LH.

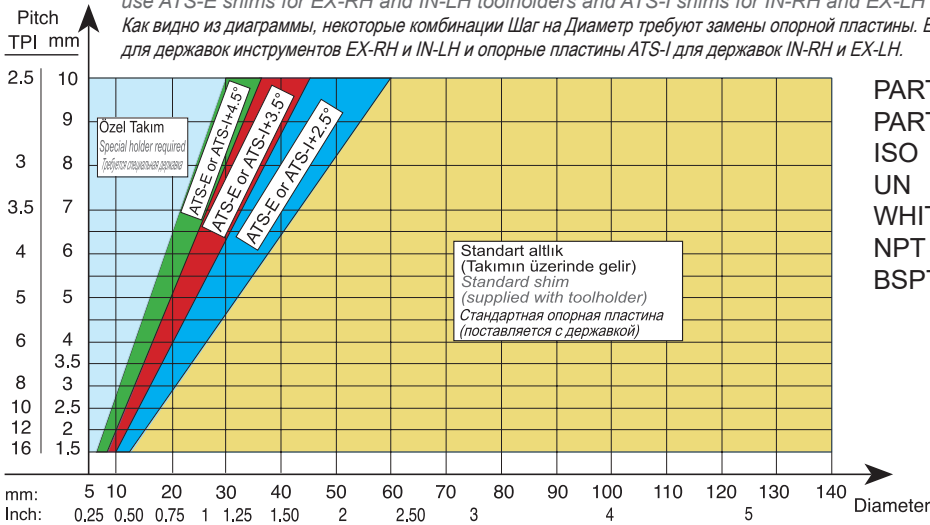

PARTIAL PROFILES 60°
 PARTIAL PROFILES 55°
 ISO
 UN
 WHIT.
 NPT
 BSPT

Tabloda da görüldüğü gibi çoğu uygulamalar altlık değişimine ihtiyaç duyar. Çoğu durumda negatif bir altlığı ihtiyaç duyulur. EX-RH ve IN-LH takımlar için ATS-E altlıklarını kullanın. IN-RH ve EX-LH takımlar için ATS-I altlıklarını kullanın.

As can be seen from the chart, most applications require a shim change. In most cases a negative shim is required, use ATS-E shims for EX-RH and IN-LH toolholders. ATS-I shims for IN-RH and EX-LH toolholders.

Как видно из диаграммы, в большинстве случаев требуется смена опорной пластины. В основном применяется отрицательная опорная пластина, используйте опорные пластины ATS-E для державок EX-RH и IN-LH. Опорные пластины ATS-I для державок IN-RH и EX-LH.

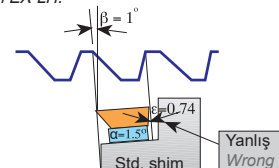
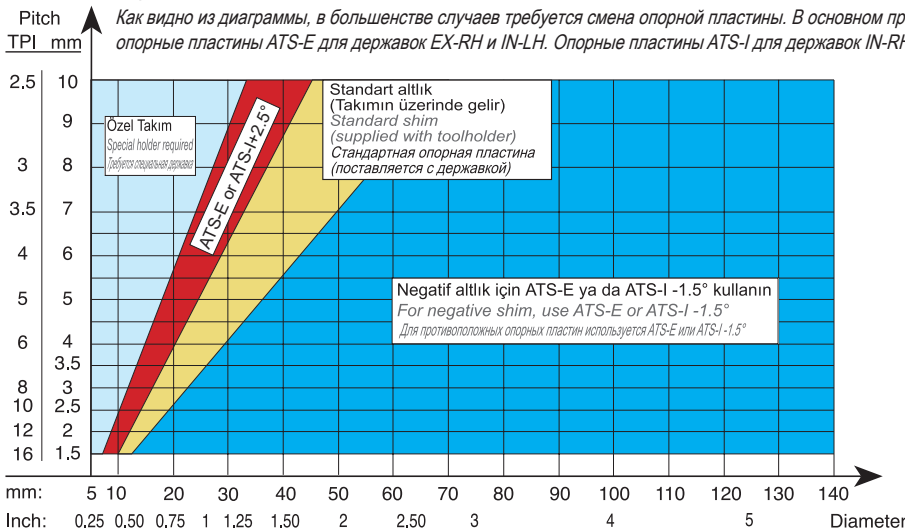

Before Shim Change
 Altlığı Değiştirmeden Önce
 До смены опорной пластины

AMERICAN
 BUTTRESS
 SAGENGWINDE
 (DIN 513)

Standart altlığın negatif bir altlıkla değiştirilmesi, kenar sürtmesini engelleyecektir.

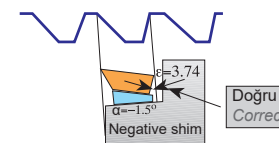

After Shim Change
 Altlığı Değiştirdikten Sonra
 После смены опорной пластины

Replacing the standard shim with a shim has negative angle, will eliminate side rubbing

Смена стандартной опорной пластины на пластину с отрицательным углом устраняет боковое трение



*konusulan
the spoken kalite...
quality...*

KANAL AÇMA

KANAL AÇMA TAKIMLARI
GROOVING TOOLHOLDERS
ДЕРЖАВКИ ДЛЯ ОБРАБОТКИ КАНАВOK



AKKO **A** **AKT** - **K** - **R** - **2525**

1 2 3 4 5

100 - 150 - **4** - **T22**

6 7 8

2 Kesici Stili / Cutter Style / Тип режущего инструмента

DKT: Dış Çap Kanal Açma Takımı / External Grooving Toolholders
ДЕРЖАВКИ ДЛЯ ОБРАБОТКИ НАРУЖНЫХ КАНАВОК
IKT: Delik İçi Kanal Açma Takımı / Internal Grooving Toolholders
ДЕРЖАВКИ ДЛЯ ОБРАБОТКИ ВНУТРЕННИХ КАНАВОК
AKT: Dış Çap Alın Kanal Takımları / Face Grooving Toolholders
ДЕРЖАВКА ДЛЯ ОБРАБОТКИ ТОРЦЕВЫХ КАНАВОК
LKT: L Tip Alın Kanal Açma Takımı / L Type Face Grooving Toolholders
ДЕРЖАВКА L-ТИПА ДЛЯ ОБРАБОТКИ ТОРЦЕВЫХ КАНАВОК

3 Uç Tipi / Insert Type / Форма пластины

KRLY / MGM.
HRN / S312, S229, S224, S223
ISCR / DGN, GI, GTN
SNDVK / 123, 151, 154.91
ZCC
KM / A4.
ARN / LOMR.

TGTC / TD.

4 Kesme Yönü / Cutting Direction
Направление резания

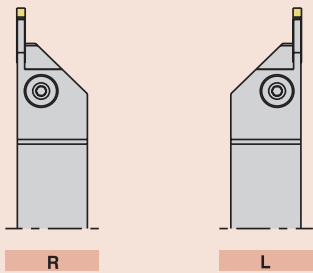

AAKT ürünler için tam tersi olmalıdır
en en
rusça

5 Kesme Kenar Yüksekliği ve Şaft Genişliği
Cutting Edge Height and Shank Width
Высота и Ширина державки

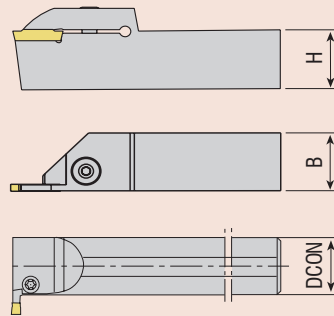

6 Kesme Aralığı
Cutting Diameter
Диаметр Резания

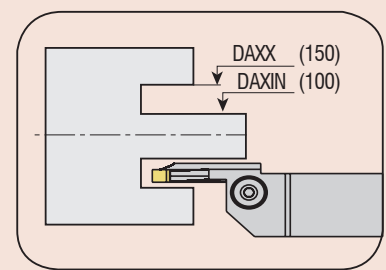

7 Kesme Kenar Genişliği / Cutting Width Edge
Ширина режущей кромки

ÖR/E.G :
2 = 2.0 mm
3 = 3.0 mm
4 = 4.0 mm
5 = 5.0 mm
6 = 6.0 mm
8 = 8.0 mm

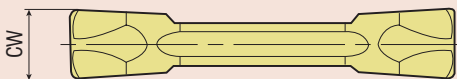

8 Kesme Derinliği / Cutting Depth / Глубина резания

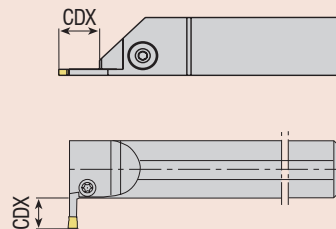

DIŞ ÇAP KANAL AÇMA TAKIMLARI
EXTERNAL GROOVING TOOLHOLDERS
ДЕРЖАВКИ ДЛЯ ОБРАБОТКИ НАРУЖНЫХ КАНАВОК

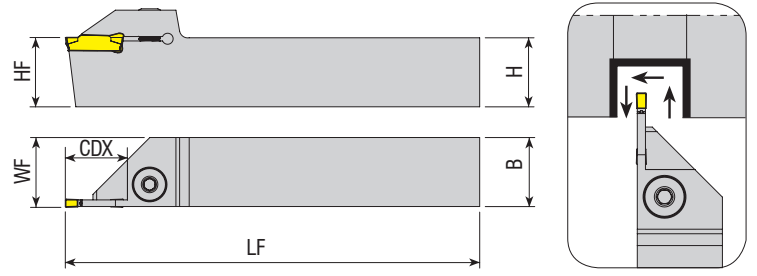

Takım Kodu Ordering Code Код для заказа	Stok Stock Наличие		Takım Ölçüleri (mm) Dimension (mm) Размеры (мм)				Kesici Uç Insert Пластина	Yedek Parçaları / Spare Parts / Запасные части			
	R	L	HF=H	B	LF	WF		CDX	Sıkma Vidası Screw Зажимной винт	Pul Stamp Шайба	Anahtar Allen Key Ключ
ADKT-K-R/L-1212-1.5-T15	●	●	12	12	100	12.2	15	MGM. - 1.5	AKV-02-M6x22	ABPL-01	AAL-03-3
ADKT-K-R/L-2020-1.5-T15	●	●	20	20	125	20.2	15				
ADKT-K-R/L-1212-2-T15	●	●	12	12	100	16.3	15				
ADKT-K-R/L-1616-2-T10	●	●	16	16	125	16.3	10				
ADKT-K-R/L-1616-2-T15	●	●	16	16	125	16.3	15				
ADKT-K-R/L-2020-2-T15	●	●	20	20	150	20.3	15				
ADKT-K-R/L-2525-2-T15	●	●	25	25	150	25.3	15				
ADKT-K-R/L-3232-2-T15	●	●	32	32	170	32.3	15				
ADKT-K-R/L-1212-3-T15	●	●	12	12	100	12.3	15				
ADKT-K-R/L-1616-3-T15	●	●	16	16	125	16.3	15				
ADKT-K-R/L-2020-3-T10	●	●	20	20	125	20.3	10				
ADKT-K-R/L-2020-3-T20	●	●	20	20	125	20.3	20				
ADKT-K-R/L-2020-3-R28	●	●	20	20	125	20.3	28				
ADKT-K-R/L-2525-3-T10	●	●	25	25	150	25.3	10				
ADKT-K-R/L-2525-3-R15	●	●	25	25	150	25.3	15				
ADKT-K-R/L-2525-3-T22	●	●	25	25	150	25.3	22				
ADKT-K-R/L-3232-3-T10	●	●	32	32	170	32.3	10				
ADKT-K-R/L-3232-3-T22	●	●	32	32	170	32.3	22				
ADKT-K-R/L-2020-4-T10	●	●	20	20	125	20.4	10				
ADKT-K-R/L-2020-4-T20	●	●	20	20	125	20.4	20				
ADKT-K-R/L-2020-4-R25	●	○	20	20	125	20.4	25				
ADKT-K-R/L-2525-4-T10	●	●	25	25	150	25.4	10				
ADKT-K-R/L-2525-4-T18	●	●	25	25	150	25.4	18				
ADKT-K-R/L-2525-4-T22	●	●	25	25	150	25.4	22				
ADKT-K-R/L-3232-4-T10	●	●	32	32	170	32.4	10				
ADKT-K-R/L-3232-4-T22	●	●	32	32	170	32.4	22				
ADKT-K-R/L-2020-5-T20	●	●	20	20	125	20.5	20				
ADKT-K-R/L-2525-5-T15	●	●	25	25	150	25.5	15				
ADKT-K-R/L-2525-5-T18	●	●	25	25	150	25.5	18				
ADKT-K-R/L-2525-5-T25	●	●	25	25	150	25.5	25				
ADKT-K-R/L-3232-5-T15	●	●	32	32	170	32.5	15				
ADKT-K-R/L-3232-5-T25	●	●	32	32	170	32.5	25				
ADKT-K-R/L-2525-6-T15	●	●	25	25	150	25.6	15				
ADKT-K-R/L-2525-6-T25	●	●	25	25	150	25.6	25				
ADKT-K-R/L-3232-6-T25	●	●	32	32	170	32.6	25				
ADKT-K-R/L-3232-8-T32	●	●	32	32	170	32.8	32				
								MGM. - 4	2004-M8x1x20	-	AAL-05-4
								MGM. - 5			
								MGM. - 6			
								MGM. - 8			

R: Sağ / Right / Правый L: Sol / Left / Левый

● Stokta / In Stock / В наличии ○ Stokta Yok / Non Stock Item / Нет в наличии

KRLY - JD Ucuna Uygunudur. / Compatible with KRLY - JD Insert. / Под пластину KRLY - JD

Sipariş Örneği/Ordering Example/Образец заказа

1 ad./pcs./шт. ADKT-K-R-1212-1.5-T15

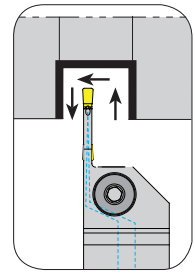
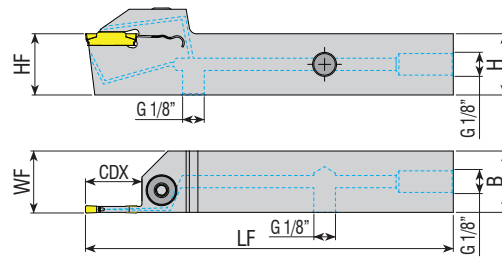
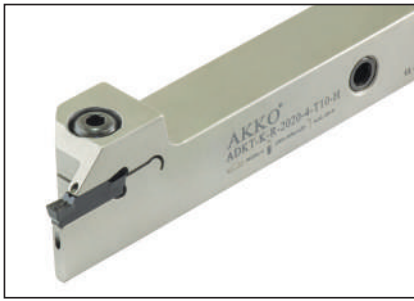

Takım Kodu Ordering Code Код для заказа	Stok Stock Наличие		Takım Ölçüleri (mm) Dimension (mm) Размеры (мм)				Kesici Uç Insert Пластина	Yedek Parçaları / Spare Parts / Запасные части			
	R	L	HF=H	B	LF	WF		CDX	Sıkma Vidası Screw Зажимной винт	Pul Stamp Шайба	Anahtar Allen Key Ключ
ADKT-K-R/L-2020-3-T20-H	●	●	20	20	125	20.4	20	MGM. - 3	2004-M8x1x20	-	AAL-05-4
ADKT-K-R/L-2525-3-T22-H	●	●	25	25	150	25.4	22				
ADKT-K-R/L-2020-4-T20-H	●	●	20	20	125	20.4	20	MGM. - 4			
ADKT-K-R/L-2525-4-T22-H	●	●	25	25	150	25.4	22				
ADKT-K-R/L-2525-5-T25-H	●	●	25	25	150	25.5	25	MGM. - 5			

KRLY Ucuna Uygun. / Compatible with KRLY Insert. / Под пластину KRLY.

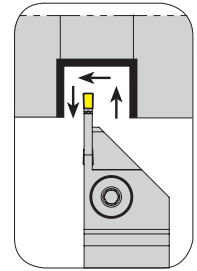
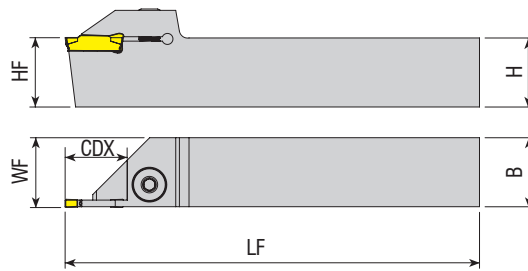

Takım Kodu Ordering Code Код для заказа	Stok Stock Наличие		Takım Ölçüleri (mm) Dimension (mm) Размеры (мм)				Kesici Uç Insert Пластина	Yedek Parçaları / Spare Parts / Запасные части			
	R	L	HF=H	B	LF	WF		CDX	Sıkma Vidası Screw Зажимной винт	Pul Stamp Шайба	Anahtar Allen Key Ключ
ADKT-KG-R/L-2020-2-T15	●	●	20	20	125	20.2	15	KG.. - 2	AKV-02-M6x22	ABPL-01	AAL-03-3
ADKT-KG-R/L-2525-2-T8	●	●	25	25	150	25.2	8				
ADKT-KG-R/L-2525-2-T15	●	○	25	25	150	25.2	15				
ADKT-KG-R/L-2525-2-T17	●	○	25	25	150	25.2	17	KG.. - 3	2004-M8x1x20	-	AAL-05-4
ADKT-KG-R/L-1616-3-T20	●	●	16	16	125	16.3	20				
ADKT-KG-R/L-2020-3-T20	●	●	20	20	125	20.3	20				
ADKT-KG-R/L-2525-3-T10	●	●	25	25	150	25.3	10				
ADKT-KG-R/L-2525-3-T13	●	●	25	25	150	25.3	13				
ADKT-KG-R/L-2525-3-T22	●	●	25	25	150	25.3	22				
ADKT-KG-R/L-2020-4-T20	●	●	20	20	125	20.4	20	KG.. - 4			
ADKT-KG-R/L-2525-4-T10	●	●	25	25	150	25.4	10				
ADKT-KG-R/L-2525-4-T16	●	○	25	25	150	25.4	16	KG.. - 5			
ADKT-KG-R/L-2525-4-T22	●	○	25	25	150	25.4	22				
ADKT-KG-R/L-2525-5-T12	●	●	25	25	150	25.5	12	KG.. - 6			
ADKT-KG-R/L-2525-5-T15	●	●	25	25	150	25.5	15				
ADKT-KG-R/L-2525-5-T25	●	○	25	25	150	25.5	25				
ADKT-KG-R/L-2525-6-T25	○	○	25	25	150	25.6	25				

R: Sağ / Right / Правый L: Sol / Left / Левый

● Stokta / In Stock / В наличии ○ Stokta Yok / Non Stock Item / Нет в наличии

KRLY Ucuna Uygun. / Compatible with KRLY Insert. / Под пластину KRLY

Sipariş Örneği/Ordering Example/Образец заказа

1 ad./pcs./шт. ADKT-K-R-2020-3-T20-H

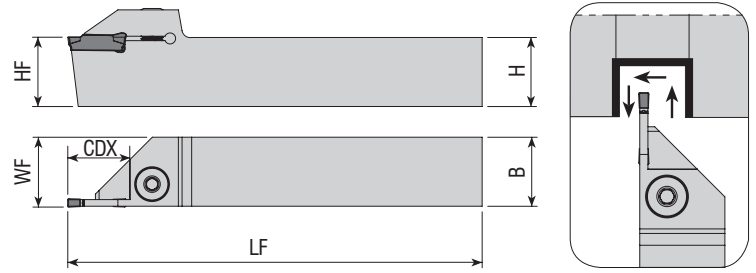

Takım Kodu Ordering Code Код для заказа	Stok Stock Наличие		Takım Ölçüleri (mm) Dimension (mm) Размеры (мм)					Kesici Uç Insert Пластина	Yedek Parçaları / Spare Parts / Запасные части		
	R	L	HF=H	B	LF	WF	CDX		Sıkma Vidası Screw Зажимной винт	Pul Stamp Шайба	Anahtar Allen Key Ключ
ADKT-SGC-R/L-1212-2-R15	●	●	12	12	100	16.2	15	GCM N20	AKV-02-M6x22	ABPL-01	AAL-03-3
ADKT-SGC-R/L-1616-2-R15	●	●	16	16	125	16.2	15				
ADKT-SGC-R/L-2020-2-R20	●	●	20	20	125	20.2	20				
ADKT-SGC-R/L-2525-2-R20	●	●	25	25	150	25.2	20	GCM N30	2004-M8x1x20	-	AAL-05-4
ADKT-SGC-R/L-1212-3-R15	●	●	12	12	100	16.3	15				
new ADKT-SGC-R/L-1616-3-T12	●	○	16	16	125	16.3	12				
ADKT-SGC-R/L-1616-3-R15	●	●	16	16	125	16.3	15				
ADKT-SGC-R/L-2020-3-R22	●	●	20	20	125	20.3	22				
ADKT-SGC-R/L-2525-3-R15	●	○	25	25	150	25.3	15				
ADKT-SGC-R/L-2525-3-R22	●	●	25	25	150	25.3	22	GCM N40			
ADKT-SGC-R/L-2525-4-R25	●	○	25	25	150	25.4	25				

SMTM Uçuna Uygundur. / Compatible with SMTM Insert. / Под пластину SMTM

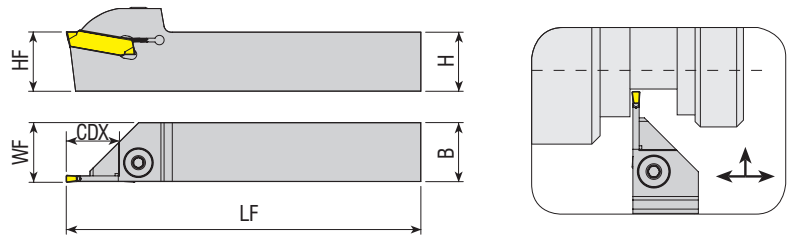

Takım Kodu Ordering Code Код для заказа	Stok Stock Наличие		Takım Ölçüleri (mm) Dimension (mm) Размеры (мм)					Kesici Uç Insert Пластина	Yedek Parçaları / Spare Parts / Запасные части		
	R	L	HF=H	B	LF	WF	CDX		Sıkma Vidası Screw Зажимной винт	Pul Stamp Шайба	Anahtar Allen Key Ключ
ADKT-H-R/L-2020-3-T20	●	●	20	20	125	20.5	20	S229 - 3	2004-M8x1x20	-	AAL-05-4
ADKT-H-R/L-2525-3-T22	●	●	25	25	150	25.5	22				
ADKT-H-R/L-2525-3-T26	●	●	25	25	150	25.5	26				
ADKT-H-R/L-2020-4-T20	●	●	20	20	125	20.5	20	S229 - 4			
ADKT-H-R/L-2525-4-T22	●	●	25	25	150	25.5	22				
ADKT-H-R/L-3232-4-T22	●	●	32	32	170	32.5	22	S229 - 5			
ADKT-H-R/L-2020-5-T20	●	●	20	20	125	20.5	20				
ADKT-H-R/L-2525-5-T25	●	●	25	25	150	25.5	25				
ADKT-H-R/L-2525-6-T25	●	●	25	25	150	25.6	25	S229 - 6			

R: Sağ / Right / Правый L: Sol / Left / Левый
● Stokta / In Stock / В наличии ○ Stokta Yok / Non Stock Item / Нет в наличии
HRN Uçuna Uygundur. / Compatible with HRN Insert. / Под пластину HRN

Sipariş Örneği/Ordering Example/Образец заказа
1 ad./pcs./шт. ADKT-SGC-R-1212-2-R15

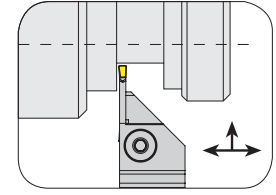
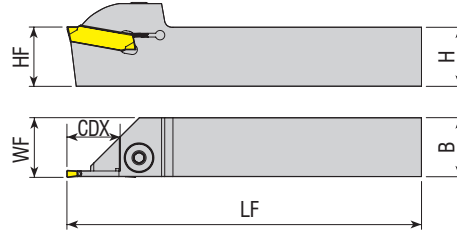

Takım Kodu Ordering Code Код для заказа	Stok Stock Наличие		Takım Ölçüleri (mm) Dimension (mm) Размеры (мм)				Kesici Uç Insert Пластина	Yedek Parçaları / Spare Parts / Запасные части			
	R	L	HF=H	B	LF	WF		CDX	Sıkma Vidası Screw Зажимной винт	Pul Stamp Шайба	Anahtar Allen Key Ключ
ADKT-HK-R/L-1616-2-T15	●	●	16	16	125	16.3	15	S224 - 2	AKV-02-M6x22	ABPL-01	AAL-03-3
ADKT-HK-R/L-2020-2-T15	●	●	20	20	125	20.3	15				
ADKT-HK-R/L-2525-2-T15	●	●	25	25	150	25.3	15				
ADKT-HK-R/L-1616-3-T15	○	○	16	16	125	16.3	15	S224 - 3	2004-M8x1x20	-	AAL-05-4
ADKT-HK-R/L-2020-3-T20	●	●	20	20	125	20.4	20				
ADKT-HK-R/L-2525-3-T22	●	●	25	25	150	25.4	22				
ADKT-HK-R/L-2020-4-T20	●	●	20	20	125	20.4	20				
ADKT-HK-R/L-2525-4-T22	●	●	25	25	150	25.4	22	S224 - 4			
ADKT-HS223-R/L-2020-2-T15	●	○	20	20	125	20.4	15	S223 - 2	AKV-02-M6x22	ABPL-01	AAL-03-3
ADKT-HS223-R/L-2020-3-T17	●	○	20	20	125	20.3	17	S223 - 3	2004-M8x1x20	-	AAL-05-4

HRN Ucuna Uygundur. / Compatible with HRN Insert. / Под пластину HRN

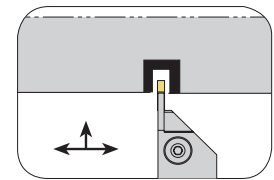
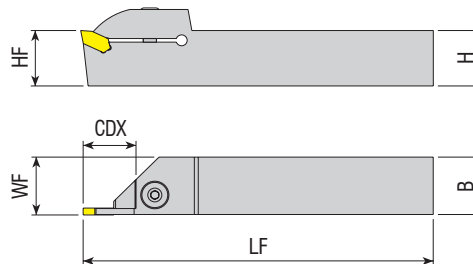

Takım Kodu Ordering Code Код для заказа	Stok Stock Наличие		Takım Ölçüleri (mm) Dimension (mm) Размеры (мм)				Kesici Uç Insert Пластина	Yedek Parçaları / Spare Parts / Запасные части			
	R	L	HF=H	B	LF	WF		CDX	Sıkma Vidası Screw Зажимной винт	Pul Stamp Шайба	Anahtar Allen Key Ключ
ADKT-ZCC1-R/L-2020-3-T20	●	○	20	20	125	20.3	20	ZQMX - 3	2004-M8x1x20	-	AAL-05-4
ADKT-ZCC1-R/L-2525-3-T22	●	○	25	25	150	25.3	22				
ADKT-ZCC1-R/L-2020-4-T20	●	○	20	20	125	20.4	20	ZQMX - 4			
ADKT-ZCC1-R/L-2525-4-T22	●	○	25	25	150	25.4	22				

R: Sağ / Right / Правый L: Sol / Left / Левый
● Stokta / In Stock / В наличии ○ Stokta Yok / Non Stock Item / Нет в наличии
ZCC Ucuna Uygundur. / Compatible with ZCC Insert. / Под пластину ZCC.

Sipariş Örneği/Ordering Example/Образец заказа
1 ad./pcs./шт. ADKT-HK-R-1616-2-T15

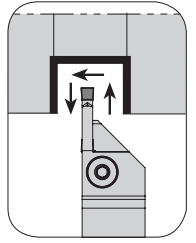
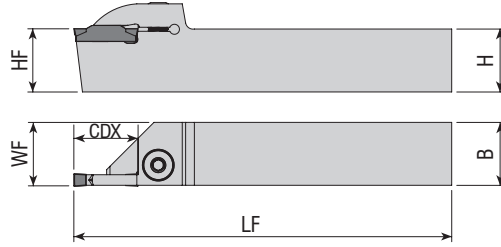

Takım Kodu Ordering Code Код для заказа	Stok Stock Наличие		Takım Ölçüleri (mm) Dimension (mm) Размеры (мм)					Kesici Uç Insert Пластина	Yedek Parçaları / Spare Parts / Запасные части			
	R	L	HF=H	B	LF	WF	CDX		Sıkma Vidası Screw Зажимной винт	Pul Stamp Шайба	Anahtar Allen Key Ключ	
ADKT-ZCC2-R/L-1616-2-T15	●	●	16	16	125	16.2	15	Z.BD - 2	AKV-02-M6x22	ABPL-01	AAL-03-3	
ADKT-ZCC2-R/L-2020-2-T7	●	●	20	20	125	20.2	7					
ADKT-ZCC2-R/L-2020-2-T15	●	●	20	20	125	20.2	15					
ADKT-ZCC2-R/L-2525-2-T15	●	●	25	25	150	25.2	15	Z.ED - 2.5				
ADKT-ZCC2-R/L-1616-2.5-T15	●	●	16	16	125	16.3	15					
ADKT-ZCC2-R/L-2020-2.5-T17	●	●	20	20	125	20.3	17					
ADKT-ZCC2-R/L-2525-2.5-T15	●	●	25	25	150	25.3	15	Z.FD - 3				
ADKT-ZCC2-R/L-1616-3-T15	●	●	16	16	125	16.3	15					
ADKT-ZCC2-R/L-1616-3-T17	●	○	16	16	125	16.3	17					
ADKT-ZCC2-R/L-1616-3-T20	●	○	16	16	125	16.3	20	Z.GD - 4	2004-M8x1x20	-	AAL-05-4	
ADKT-ZCC2-R/L-2020-3-T12	●	●	20	20	125	20.3	12					
ADKT-ZCC2-R/L-2020-3-T20	●	●	20	20	125	20.3	20					
ADKT-ZCC2-R/L-2020-3-R21	●	○	20	20	125	20.3	21	Z.HD - 5				
ADKT-ZCC2-R/L-2020-3-R25	●	●	20	20	125	20.3	25					
ADKT-ZCC2-R/L-2525-3-T12	●	○	25	25	150	25.3	12					
ADKT-ZCC2-R/L-2525-3-T22	●	●	25	25	150	25.3	22	Z.KD - 6				
ADKT-ZCC2-R/L-2525-3-R30	●	●	25	25	150	25.3	30					
ADKT-ZCC2-R/L-2020-4-T12	●	○	20	20	125	20.5	12					
ADKT-ZCC2-R/L-2020-4-T20	●	●	20	20	125	20.5	20	Z.HD - 5				
ADKT-ZCC2-R/L-2525-4-T12	●	●	25	25	150	25.5	12					
ADKT-ZCC2-R/L-2525-4-T22	●	●	25	25	150	25.5	22					
ADKT-ZCC2-R/L-2020-5-T12	●	○	20	20	125	20.5	12	Z.KD - 6				
ADKT-ZCC2-R/L-2020-5-T20	●	●	20	20	125	20.5	20					
ADKT-ZCC2-R/L-2525-5-T12	●	○	25	25	150	25.5	12					
ADKT-ZCC2-R/L-2525-5-T25	●	●	25	25	150	25.5	25	Z.KD - 6				
ADKT-ZCC2-R/L-3232-5-T25	●	●	32	32	170	32.5	25					
ADKT-ZCC2-R/L-2020-6-T20	●	●	20	20	125	20.6	20					
ADKT-ZCC2-R/L-2525-6-T25	●	●	25	25	150	25.6	25	Z.KD - 6				
ADKT-ZCC2-R/L-3232-6-T25	●	●	32	32	170	32.6	25					
ADKT-ZCC2-R/L-3232-6-T30	●	●	32	32	170	32.6	30					

R: Sağ / Right / Правый L: Sol / Left / Левый
● Stokta / In Stock / В наличии ○ Stokta Yok / Non Stock Item / Нет в наличии
ZCC Ucuna Uygundur. / Compatible with ZCC Insert. / Под пластину ZCC

Sipariş Örneği/Ordering Example/Образец заказа
1 ad./pcs./шт. ADKT-ZCC2-R-1616-2-T15

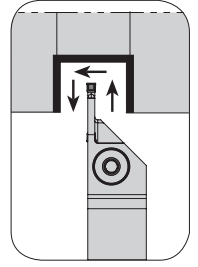
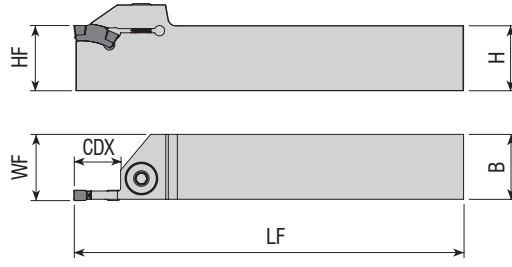

Takım Kodu Ordering Code Код для заказа	Stok Stock Наличие		Takım Ölçüleri (mm) Dimension (mm) Размеры (мм)				Kesici Uç Insert Пластина	Yedek Parçaları / Spare Parts / Запасные части			
	R	L	HF=H	B	LF	WF		CDX	Sıkma Vidası Screw Зажимной винт	Pul Stamp Шайба	Anahtar Allen Key Ключ
ADKT-ITG-R/L-2020-3-T8	●	●	20	20	125	20.3	8	TGM. - 3	2004-M8x1x20	-	AAL-05-4
ADKT-ITG-R/L-2525-3-T8	●	●	25	25	150	25.3	8				
ADKT-ITG-R/L-3232-3-T8	●	○	32	32	170	32.3	8				
ADKT-ITG-R/L-2020-4-T9	●	●	20	20	125	20.4	9	TGM. - 4	2004-M8x1x20	-	AAL-05-4
ADKT-ITG-R/L-2525-4-T17	●	●	25	25	150	25.4	17				
ADKT-ITG-R/L-3232-4-T17	●	●	32	32	170	32.4	17				
ADKT-ITG-R/L-3232-5-T25	●	○	32	32	170	32.5	25	TGM. - 5			

ISCR Ucuna Uygundur. / Compatible with ISCR Insert. / Под пластину ISCR.

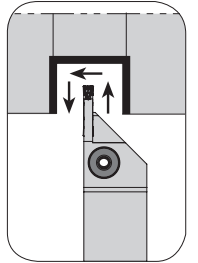
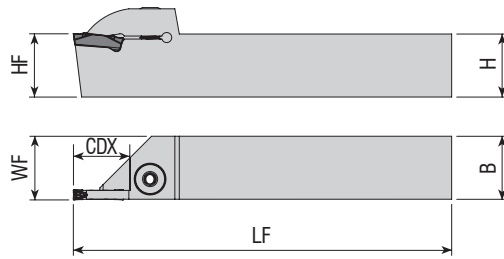

Takım Kodu Ordering Code Код для заказа	Stok Stock Наличие		Takım Ölçüleri (mm) Dimension (mm) Размеры (мм)				Kesici Uç Insert Пластина	Yedek Parçaları / Spare Parts / Запасные части			
	R	L	HF=H	B	LF	WF		CDX	Sıkma Vidası Screw Зажимной винт	Pul Stamp Шайба	Anahtar Allen Key Ключ
ADKT-KM-R/L-2020-2-T15	●	●	20	20	125	20.3	15	A4. - 2	AKV-02-M6x22	ABPL-01	AAL-03-3
ADKT-KM-R/L-2525-2-T15	●	●	25	25	150	25.3	15				
ADKT-KM-R/L-2020-3-T20	●	●	20	20	125	20.4	20	A4. - 3	2004-M8x1x20	-	AAL-05-4
ADKT-KM-R/L-2525-3-T22	●	●	25	25	150	25.4	22				
ADKT-KM-R/L-2525-4-T22	●	●	25	25	150	25.5	22				

R: Sağ / Right / Правый L: Sol / Left / Левый

● Stokta / In Stock / В наличии ○ Stokta Yok / Non Stock Item / Нет в наличии

KNMTL Ucuna Uygundur. / Compatible with KNMTL Insert. / Под пластину KNMTL.

Sipariş Örneği/Ordering Example/Образец заказа

1 ad./pcs./шт. ADKT-ITG-R-2020-3-T8

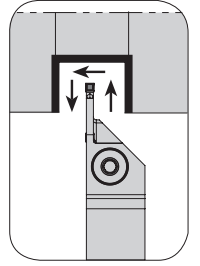
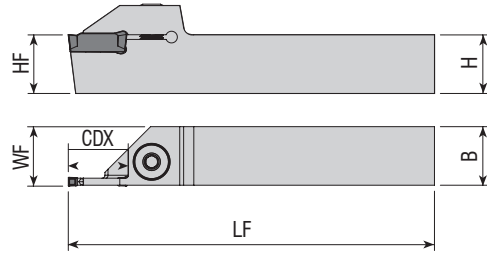

Takım Kodu Ordering Code Код для заказа	Stok Stock Наличие		Takım Ölçüleri (mm) Dimension (mm) Размеры (мм)				Kesici Uç Insert Пластина	Yedek Parçaları / Spare Parts / Запасные части			
	R	L	HF=H	B	LF	WF		CDX	Sıkma Vidası Screw Зажимной винт	Pul Stamp Шайба	Anahtar Allen Key Ключ
ADKT-I-R/L-1212-2-T15	●	●	12	12	125	16.3	15	DGN - 2	AKV-02-M6x22	ABPL-01	AAL-03-3
ADKT-I-R/L-1616-2-T15	●	●	16	16	100	16.3	15				
ADKT-I-R/L-2020-2-T15	●	●	20	20	125	20.3	15				
ADKT-I-R/L-2525-2-T15	●	●	25	25	150	25.3	15				
ADKT-I-R/L-3232-2-T15	●	●	32	32	170	32.3	15				
ADKT-I-R/L-1212-3-T15	●	●	12	12	100	16.3	15	DGN - 3			
ADKT-I-R/L-1616-3-T15	●	●	16	16	125	16.3	15				
ADKT-I-R/L-2020-3-T12	●	●	20	20	125	20.3	12				
ADKT-I-R/L-2020-3-T20	●	●	20	20	125	20.3	20				
ADKT-I-R/L-2525-3-T12	●	●	25	25	150	25.3	12				
ADKT-I-R/L-2525-3-T22	●	●	25	25	150	25.3	22	DGN / GRP - 4	2004-M8x1x20	-	AAL-05-4
ADKT-I-R/L-3232-3-T22	●	●	32	32	170	32.3	22				
ADKT-I-R/L-2020-4-T20	●	●	20	20	125	20.4	20				
ADKT-I-R/L-2525-4-T12	●	●	25	25	150	25.4	12				
ADKT-I-R/L-2525-4-T22	●	●	25	25	150	25.4	22				
ADKT-I-R/L-3232-4-T25	●	●	32	32	170	32.4	25	DGN / GRP - 5			
ADKT-I-R/L-2020-5-T20	●	●	20	20	125	20.5	20				
ADKT-I-R/L-2525-5-T12	●	●	25	25	150	25.5	12				
ADKT-I-R/L-2525-5-T25	●	●	25	25	150	25.5	25				
ADKT-IG-R/L-1616-3-T18	●	○	16	16	125	16.3	18				
ADKT-IG-R/L-2020-3-T12	●	●	20	20	125	20.3	12				
ADKT-IG-R/L-2020-3-R20	●	●	20	20	125	20.3	20				
ADKT-IG-R/L-2525-3-T12	●	●	25	25	150	25.3	12				
ADKT-IG-R/L-2525-3-T22	●	●	25	25	150	25.3	22				
ADKT-IGI-R/L-2020-2-T15	●	●	20	20	125	20.3	15	GIM / GIP - 2	AKV-02-M6x22	ABPL-01	AAL-03-3
ADKT-IGI-R/L-2525-2-T15	●	●	25	25	150	25.3	15				
ADKT-IGI-R/L-1616-3-T15	●	●	16	16	125	16.3	15	GIM / GIP - 3			
ADKT-IGI-R/L-2020-3-T20	●	●	20	20	125	20.3	20				
ADKT-IGI-R/L-2525-3-T9	●	●	25	25	150	25.3	9				
ADKT-IGI-R/L-2525-3-T22	●	●	25	25	150	25.3	22				
ADKT-IGI-R/L-2525-4-T22	●	●	25	25	150	25.4	22				
ADKT-IGI-R/L-2525-5-T25	●	●	25	25	150	25.5	25	GIM / GIP - 4	2004-M8x1x20		
ADKT-IGI-R/L-2525-8-T25	●	○	25	25	150	25.8	25	GIM / GIP - 5			
ADKT-IGI-R/L-2525-8-T30	●	○	25	25	150	25.8	30	GIM / GIP - 8	2505-M6x20		AAL-07-5
ADKT-IGTN-R/L-2525-5-T25	●	●	25	25	150	25.6	25	GTN - 5	2004-M8x1x20		AAL-03-3
ADKT-IDC-R/L-1616-2-D35	○	●	16	16	140	16.2	35	DCE - 2	2503-M4x19		AAL-05-4
ADKT-IDC-R/L-2020-2-R23	●	○	20	20	125	20.2	23				
ADKT-IDC-R/L-2525-2-R23	●	○	25	25	150	25.2	23	DCE - 3	AKV-02-M6x22	ABPL-01	AAL-03-3
ADKT-IDC-R/L-1616-3-D35	●	○	16	16	140	16.3	35				
ADKT-IDC-R/L-2525-3-T21	●	○	25	25	150	25.4	21		2504-M5x18		
									2004-M8x1x20	-	AAL-05-4

R: Sağ / Right / Правый L: Sol / Left / Левый

● Stokta / In Stock / В наличии ○ Stokta Yok / Non Stock Item / Нет в наличии
ISCR Ucuna Uygunudur. / Compatible with ISCR Insert. / Под пластину ISCR.



www.akkо.com.tr

Sipariş Örneği/Ordering Example/Образец заказа
1 ad./pcs./шт. ADKT-I-R-1212-2-T15

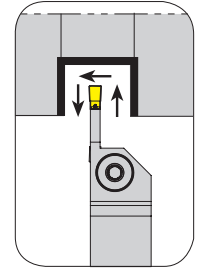
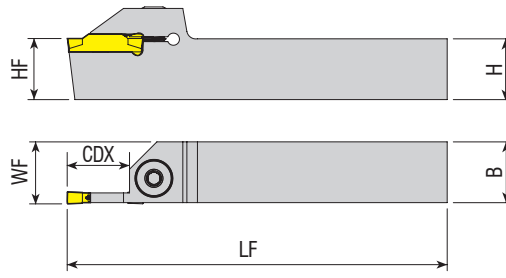

Takım Kodu Ordering Code Код для заказа	Stok Stock Наличие		Takım Ölçüleri (mm) Dimension (mm) Размеры (мм)				Kesici Uç Insert Пластина	Yedek Parçaları / Spare Parts / Запасные части			
	R	L	HF=H	B	LF	WF		CDX	Sıkma Vidası Screw Зажимной винт	Pul Stamp Шайба	Anahtar Allen Key Ключ
ADKT-123-R/L-1212-1.5-R15	●	●	12	12	100	12.2	15	123 - 1.5	AKV-02-M6x22	ABPL-01	AAL-03-3
ADKT-123-R/L-1616-1.5-R15	●	●	16	16	125	16.2	15				
new ADKT-123-R/L-2012-1.5-R15	○	●	20	12	125	12.5	15				
ADKT-123-R/L-1616-2-T15	●	○	16	16	125	16.2	15	123 - 2	AKV-02-M6x22	ABPL-01	AAL-03-3
ADKT-123-R/L-2020-2-T8	●	●	20	20	125	20.2	8				
ADKT-123-R/L-2020-2-T15	●	●	20	20	125	20.2	15				
ADKT-123-R/L-2525-2-T8	●	●	25	25	150	25.2	8				
ADKT-123-R/L-2525-2-T15	●	●	25	25	150	25.2	15				
ADKT-123-R/L-3232-2-T15	●	●	32	32	170	32.2	15				
ADKT-123-R/L-1616-3-T10	●	●	16	16	125	16.3	10	123 - 3	2004-M8x1x20	-	AAL-05-4
ADKT-123-R/L-1616-3-T15	●	●	16	16	125	16.3	15				
ADKT-123-R/L-2020-3-T10	●	●	20	20	125	20.3	10				
ADKT-123-R/L-2020-3-T15	●	●	20	20	125	20.3	15				
ADKT-123-R/L-2020-3-T20	●	●	20	20	125	20.3	20				
ADKT-123-R/L-2525-3-T10	●	●	25	25	150	25.3	10				
ADKT-123-R/L-2525-3-T15	●	●	25	25	150	25.3	15	123 - 4	2004-M8x1x20	-	AAL-05-4
ADKT-123-R/L-2525-3-T22	●	●	25	25	150	25.3	22				
ADKT-123-R/L-2020-4-T20	●	●	20	20	125	20.4	20				
ADKT-123-R/L-2525-4-T13	●	●	25	25	150	25.4	13				
ADKT-123-R/L-2525-4-T22	●	●	25	25	150	25.4	22	123 - 5	2004-M8x1x20	-	AAL-05-4
ADKT-123-R/L-3232-4-T25	●	●	32	32	170	32.4	25				
ADKT-123-R/L-2020-5-T20	●	●	20	20	125	20.5	20	123 - 6	2004-M8x1x20	-	AAL-05-4
ADKT-123-R/L-2525-5-T25	●	●	25	25	150	25.5	25				
ADKT-123-R/L-3232-6-T15	●	●	32	32	170	32.5	15	123 - 6	2004-M8x1x20	-	AAL-05-4

R: Sağ / Right / Правый L: Sol / Left / Левый

● Stokta / In Stock / В наличии ○ Stokta Yok / Non Stock Item / Нет в наличии

SNDVK Ucuna Uygundur. / Compatible with SNDVK Insert. / Под пластину SNDVK.

Sipariş Örneği/Ordering Example/Образец заказа

1 ad./pcs./шт. ADKT-123-R-1212-1.5-R15

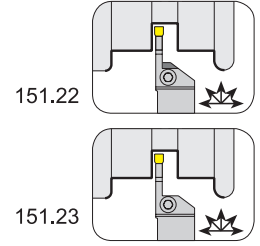
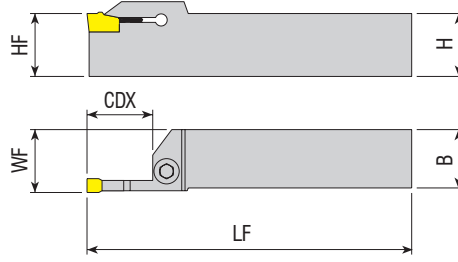

Takım Kodu Ordering Code Код для заказа	Stok Stock Наличие		Takım Ölçüleri (mm) Dimension (mm) Размеры (мм)				Kesici Uç Insert Пластина	Yedek Parçaları / Spare Parts / Запасные части			
	R	L	HF=H	B	LF	WF		CDX	Sıkma Vidası Screw Зажимной винт	Pul Stamp Шайба	Anahtar Allen Key Ключ
ADKT-151.22-R/L-1616-2-T15	●	●	16	16	125	16.3	15	151.2 - 2	AKV-02-M6x22	ABPL-01	AAL-03-3
ADKT-151.22-R/L-2020-2-T15	●	●	20	20	125	20.3	15				
ADKT-151.22-R/L-2525-2-T15	●	●	25	25	150	25.3	15	151.2 - 3	2004-M8x1x20	-	AAL-05-4
ADKT-151.22-R/L-1616-3-T15	●	●	16	16	125	16.4	15				
ADKT-151.22-R/L-2020-3-T20	●	●	20	20	125	20.4	20	151.2 - 4	2004-M8x1x20	-	AAL-05-4
ADKT-151.22-R/L-2525-3-T22	●	●	25	25	150	25.4	22				
ADKT-151.22-R/L-1616-4-T15	●	●	16	16	125	16.4	15	151.2 - 5	2004-M8x1x20	-	AAL-05-4
ADKT-151.22-R/L-2020-4-T20	●	●	20	20	125	20.4	20				
ADKT-151.22-R/L-2525-4-T22	●	●	25	25	150	25.4	22	151.2 - 5	2004-M8x1x20	-	AAL-05-4
ADKT-151.22-R/L-2020-5-T20	●	●	20	20	125	20.5	20				
ADKT-151.22-R/L-2525-5-T25	●	●	25	25	150	25.5	25	151.2 - 2	AKV-02-M6x22	ABPL-01	AAL-03-3
ADKT-151.23-R/L-1616-2-T15	●	●	16	16	125	16.3	15				
ADKT-151.23-R/L-2020-2-T15	●	●	20	20	125	20.3	15	151.2 - 2.5	AKV-02-M6x22	ABPL-01	AAL-03-3
ADKT-151.23-R/L-2525-2-T15	●	●	25	25	150	25.3	15				
ADKT-151.23-R/L-1616-2.5-T15	●	●	16	16	125	16.3	15	151.2 - 2.5	AKV-02-M6x22	ABPL-01	AAL-03-3
ADKT-151.23-R/L-2020-2.5-T15	●	●	20	20	125	20.3	15				
ADKT-151.23-R/L-2525-2.5-T15	●	●	25	25	150	25.3	15	151.2 - 3	2004-M8x1x20	-	AAL-05-4
ADKT-151.23-R/L-1212-3-T15	●	●	12	12	100	16.4	15				
ADKT-151.23-R/L-1616-3-T15	●	●	16	16	125	16.4	15	151.2 - 3	2004-M8x1x20	-	AAL-05-4
ADKT-151.23-R/L-2020-3-T20	●	●	20	20	125	20.4	20				
ADKT-151.23-R/L-2525-3-T20	●	●	25	25	150	25.4	20	151.2 - 4	2004-M8x1x20	-	AAL-05-4
ADKT-151.23-R/L-2525-3-T22	●	●	25	25	150	25.4	22				
ADKT-151.23-R/L-1616-4-T15	●	●	16	16	125	16.4	15	151.2 - 4	2004-M8x1x20	-	AAL-05-4
ADKT-151.23-R/L-2020-4-T20	●	●	20	20	125	20.4	20				
ADKT-151.23-R/L-2525-4-T22	●	●	25	25	150	25.4	22	151.2 - 5	2004-M8x1x20	-	AAL-05-4
ADKT-151.23-R/L-2020-5-T20	●	●	20	20	125	20.5	20				
ADKT-151.23-R/L-2525-5-T25	●	●	25	25	150	25.5	25	151.2 - 5	2004-M8x1x20	-	AAL-05-4

R: Sağ / Right / Правый L: Sol / Left / Левый

● Stokta / In Stock / В наличии ○ Stokta Yok / Non Stock Item / Нет в наличии
SNDVK Ucuna Uygundur. / Compatible with SNDVK Insert. / Под пластину SNDVK.

Sipariş Örneği/Ordering Example/Образец заказа

1 ad./pcs./шт. ADKT-151.22-R-1616-2-T15

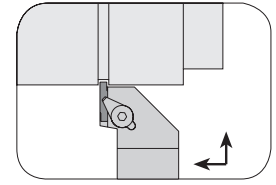
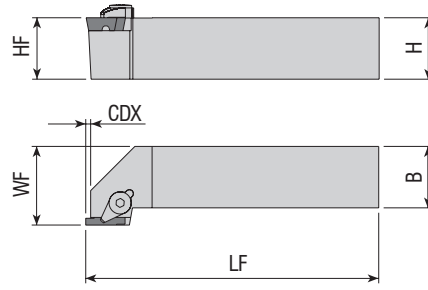

Takım Kodu Ordering Code Код для заказа	Stok Stock Наличие		Takım Ölçüleri (mm) Dimension (mm) Размеры (мм)					Kesici Uç Insert Пластина	Yedek Parçaları / Spare Parts / Запасные части				
	R	L	HF=H	B	LF	WF	CDX		Baskı Parçası Wedge Clamp Spannspratze	Sıkma Vidası Screw Зажимной винт	Pul Stamp Шайба	Anahtar Allen Key Ключ	
ADKT-154.91-R/L-2020-3-T4	●	●	20	20	125	25	4	154.91 - 3	ACK-03	AKV-07-M6x22	APM-06	AAL-03-3	
ADKT-154.91-R/L-2525-3-T4	●	●	25	25	150	30.5	4						
ADKT-154.91-R/L-2020-5-T5	●	●	20	20	125	25	5	154.91 - 5	ACK-03	AKV-07-M6x22	APM-06	AAL-03-3	
ADKT-154.91-R/L-2525-5-T5	●	●	25	25	150	30.5	5						

SNDVK Ucuna Uygunur. / Compatible with SNDVK Insert. / Под пластину SNDVK.

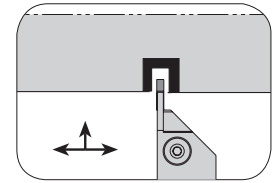
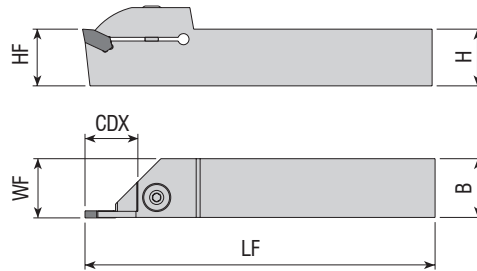

Takım Kodu Ordering Code Код для заказа	Stok Stock Наличие		Takım Ölçüleri (mm) Dimension (mm) Размеры (мм)					Kesici Uç Insert Пластина	Yedek Parçaları / Spare Parts / Запасные части			
	R	L	HF=H	B	LF	WF	CDX		Sıkma Vidası Screw Зажимной винт	Pul Stamp Шайба	Anahtar Allen Key Ключ	
ADKT-ARN-R/L-2020-2-T15	●	●	20	20	125	20.3	15	LOMR. - 2	AKV-02-M6x22	ABPL-01	AAL-03-3	
ADKT-ARN-R/L-2525-2-T15	●	●	25	25	150	25.3	15					
ADKT-ARN-R/L-2020-3-T20	●	●	20	20	125	20.4	20	LOMR. - 3	2004-M8x1x20	-	AAL-05-4	
ADKT-ARN-R/L-2525-3-T22	●	●	25	25	150	25.4	22					

R: Sağ / Right / Правый L: Sol / Left / Левый

● Stokta / In Stock / В наличии ○ Stokta Yok / Non Stock Item / Нет в наличии

ARN Ucuna Uygunur. / Compatible with ARN Insert. / Под пластину ARN

Sipariş Örneği/Ordering Example/Образец заказа

1 ad./pcs./шт. ADKT-154.91-R-2020-3-T4

DIŞ ÇAP KANAL AÇMA TAKIMLARI
EXTERNAL GROOVING TOOLHOLDERS
ДЕРЖАВКИ ДЛЯ ОБРАБОТКИ НАРУЖНЫХ КАНАВОК

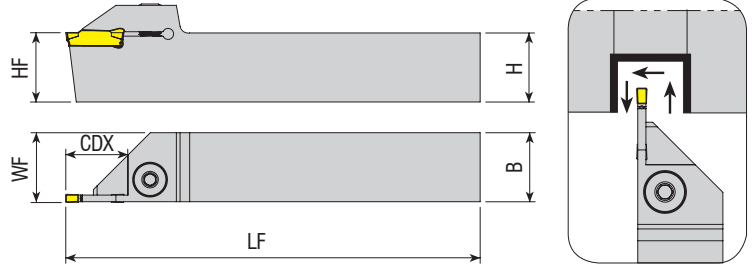

Takım Kodu Ordering Code Код для заказа	Stok Stock Наличие		Takım Ölçüleri (mm) Dimension (mm) Размеры (мм)				Kesici Uç Insert Пластина	Yedek Parçaları / Spare Parts / Запасные части			
	R	L	HF=H	B	LF	WF		CDX	Sıkma Vidası Screw Зажимной Винт	Pul Stamp Шайба	Anahtar Allen Key Ключ
ADKT-TD-R/L-1212-2-T15	●	●	12	12	100	12.2	15	TD. - 2	AKV-02-M6x22	ABPL-01	AAL-03-3
ADKT-TD-R/L-1616-2-T8	●	●	16	16	125	16.2	8				
ADKT-TD-R/L-1616-2-T15	●	●	16	16	125	16.2	15				
ADKT-TD-R/L-2020-2-T9	●	○	20	20	125	20.2	9				
ADKT-TD-R/L-2020-2-T15	●	●	20	20	125	20.2	15				
ADKT-TD-R/L-2020-2-T17	●	○	20	20	125	20.2	17				
ADKT-TD-R/L-2020-2-T20	●	○	20	20	125	20.2	20				
ADKT-TD-R/L-2525-2-T8	●	●	25	25	150	25.2	8				
ADKT-TD-R/L-2525-2-T17	●	●	25	25	150	25.2	17				
ADKT-TD-R/L-1212-3-T15	●	●	12	12	100	12.4	15				
ADKT-TD-R/L-1616-3-T15	●	●	16	16	125	16.4	15				
ADKT-TD-R/L-2020-3-T12	●	●	20	20	125	20.4	12				
ADKT-TD-R/L-2020-3-T20	●	●	20	20	125	20.4	20				
ADKT-TD-R/L-2020-3-T25	●	○	20	20	125	20.4	25				
ADKT-TD-R/L-2020-3-T30	●	●	20	20	125	20.4	30				
ADKT-TD-R/L-2525-3-T9	●	●	25	25	150	25.4	9				
ADKT-TD-R/L-2525-3-T12	●	●	25	25	150	25.4	12				
ADKT-TD-R/L-2525-3-T22	●	●	25	25	150	25.4	22				
ADKT-TD-R/L-2525-3-T25	●	●	25	25	150	25.4	25				
ADKT-TD-R/L-2525-3-T30	●	●	25	25	150	25.4	30	TD. - 4			
ADKT-TD-R/L-3232-3-T25	●	○	32	32	170	32.4	25				
ADKT-TD-R/L-2525-4-T10	●	●	25	25	150	25.5	10				
ADKT-TD-R/L-2525-4-T15	●	●	25	25	150	25.5	15				
ADKT-TD-R/L-2525-4-T22	●	●	25	25	150	25.5	22				
ADKT-TD-R/L-2525-4-T25	●	○	25	25	150	25.4	25	TD. - 5			
ADKT-TD-R/L-2525-4-T30	●	○	25	25	150	25.5	30				
ADKT-TD-R/L-2525-5-T25	●	●	25	25	150	25.5	25				

TGTC Ucuna Uygundur. / Compatible with TGTC Insert. / Под пластину TGTC.

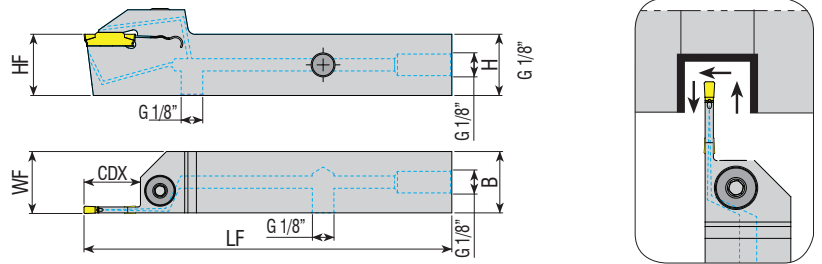

Takım Kodu Ordering Code Код для заказа	Stok Stock Наличие		Takım Ölçüleri (mm) Dimension (mm) Размеры (мм)				Kesici Uç Insert Пластина	Yedek Parçaları / Spare Parts / Запасные части			
	R	L	HF=H	B	LF	WF		CDX	Sıkma Vidası Screw Зажимной Винт	Pul Stamp Шайба	Anahtar Allen Key Ключ
ADKT-TD-R/L-2020-3-T30-H	●	●	20	20	125	20.5	30	TD. - 3	2004-M8x1x20	-	AAL-05-4

R: Sağ / Right / Правый L: Sol / Left / Левый
● Stokta / In Stock / В наличии ○ Stokta Yok / Non Stock Item / Нет в наличии
TGTC Ucuna Uygundur. / Compatible with TGTC Insert. / Под пластину TGTC.

Sipariş Örneği/Ordering Example/Образец заказа
1 ad./pcs./шт. ADKT-TD-R-1212-2-T15

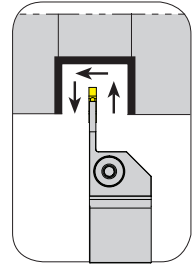
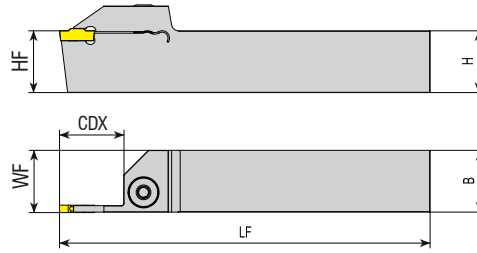

Takım Kodu Ordering Code Код для заказа	Stok Stock Наличие		Takım Ölçüleri (mm) Dimension (mm) Размеры (мм)				Kesici Uç Insert Пластина	Yedek Parçaları / Spare Parts / Запасные части				
	R	L	HF=H	B	LF	WF		CDX	Sıkma Vidası Screw Зажимной винт	Pul Stamp Шайба	Anahtar Allen Key Ключ	Tork Anahtar Torx Key Торх Ключ
ADKT-RD-R/L-1616-2-T17	●	○	16	16	125	16.2	17	RD. - 2	AKV-02-M6x22	ABPL-01	AAL-03-3	
ADKT-RD-R/L-2020-2-T17	●	○	20	20	125	20.2	17					
ADKT-RD-R/L-2525-2-T17	●	○	25	25	150	25.2	17					
ADKT-RD-R/L-1616-3-T20	●	●	16	16	125	16.3	20	RD. - 3	2004-M8x1x20	-	AAL-05-4	-
ADKT-RD-R/L-2020-3-T25	●	○	20	20	125	20.3	25					
ADKT-RD-R/L-2525-3-T25	●	○	25	25	150	25.3	25					
ADKT-RD-R/L-2020-4-T30	●	●	20	20	125	20.4	30	RD. - 4	2004-M8x1x20	-	AAL-05-4	-
ADKT-RD-R/L-2525-4-T30	●	○	25	25	150	25.5	30					

TGTC Ucuna Uygun. / Compatible with TGTC Insert. / Под пластину TGTC.

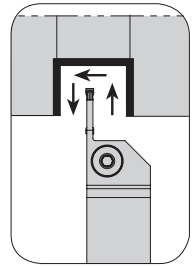
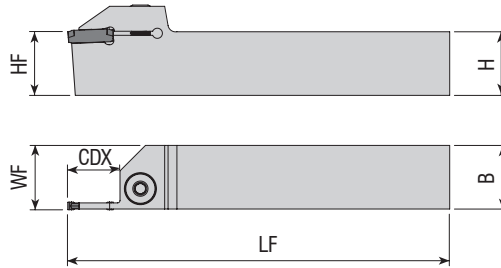

Takım Kodu Ordering Code Код для заказа	Stok Stock Наличие		Takım Ölçüleri (mm) Dimension (mm) Размеры (мм)				Kesici Uç Insert Пластина	Yedek Parçaları / Spare Parts / Запасные части				
	R	L	HF=H	B	LF	WF		CDX	Sıkma Vidası Screw Зажимной винт	Pul Stamp Шайба	Anahtar Allen Key Ключ	Tork Anahtar Torx Key Торх Ключ
ADKT-LGC-R/L-1616-2-D40	●	●	16	16	125	16.2	20	GCTX - 2	AKV-02-M6x22	ABPL-01	AAL-03-3	
ADKT-LGC-R/L-2020-2-D40	●	●	20	20	125	20.2	20					
ADKT-LGC-R/L-2525-2-D40	●	●	25	25	150	25.2	20					
ADKT-LGC-R/L-1616-3-T20	●	●	16	16	125	16.3	20	GCTX - 3	2004-M8x1x20	-	AAL-05-4	
ADKT-LGC-R/L-2020-3-T20	●	●	20	20	125	20.3	20					
ADKT-LGC-R/L-2525-3-T20	●	●	25	25	150	25.3	20					

R: Sağ / Right / Правый L: Sol / Left / Левый
● Stokta / In Stock / В наличии ○ Stokta Yok / Non Stock Item / Нет в наличии
LMN Ucuna Uygun. / Compatible with LMN Insert. / Под пластину LMN

Sipariş Örneği/Ordering Example/Образец заказа
1 ad./pcs./шт. ADKT-RD-R-1616-2-T17

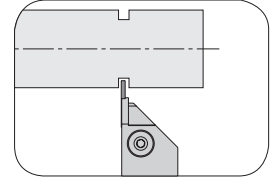
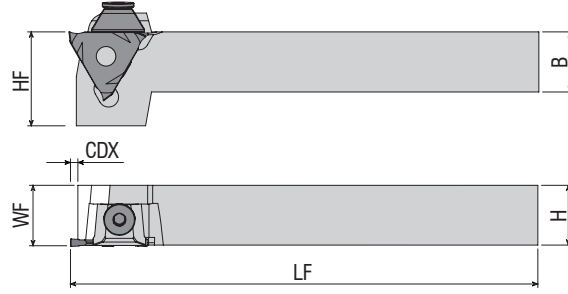

Takım Kodu Ordering Code Код для заказа	Stok Stock Наличие		Takım Ölçüleri (mm) Dimension (mm) Размеры (мм)				Kesici Uç Insert Пластина	Yedek Parçaları / Spare Parts / Запасные части				
	R	L	HF=H	B	LF	WF		CDX	Sıkma Vidası Screw Зажимной винт	Baskı Pabucu Wedge Clamp Прижим	Segman Ring Кольцо	Anahtar Allen Key Ключ
ADKT-H22-R/L-1616-(0.5-2)-T4	●	●	16	16	125	16.35	4	S312 - (0.5-2)	AKV-29-M6x29	AKK-04	AS-01	AAL-03-3
ADKT-H22-R/L-2020-(0.5-2)-T4	●	●	20	20	125	20.35	4					
new ADKT-H22-R/L-2020-(0.5-2)-T6x20	●	○	20	20	125	20.2	20					
ADKT-H22-R/L-2525-(0.5-2)-T4	●	●	25	25	150	25.35	4					
new ADKT-H22-R/L-2525-(0.5-2)-T6x20	●	○	25	25	150	20.2	2					

HRN Ucuna Uygun. / Compatible with HRN Insert. / Под пластину HRN

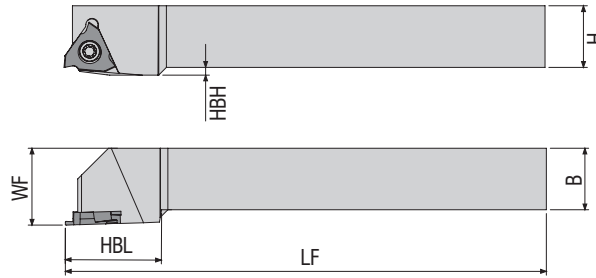
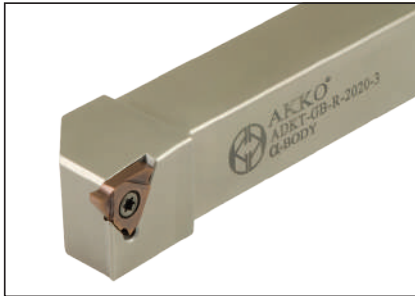

Takım Kodu Ordering Code Код для заказа	Stok Stock Наличие		Takım Ölçüleri (mm) Dimension (mm) Размеры (мм)			Kesici Uç Insert Пластина	Yedek Parçaları / Spare Parts / Запасные части			
	R	L	HF=H	B	LF		WF	Sıkma Vidası Screw Зажимной винт	Pul Stamp Шайба	Anahtar Allen Key Ключ
ADKT-GB-R/L-1212-3	●	○	12	12	100	16	GB3100	4015-M3.5x10	-	80-T15
ADKT-GB-R/L-1616-3	●	○	16	16	125	20				
ADKT-GB-R/L-2020-3	●	○	20	20	125	25				

R: Sağ / Right / Правый L: Sol / Left / Левый

● Stokta / In Stock / В наличии ○ Stokta Yok / Non Stock Item / Нет в наличии

XTC-GSC Ucuna Uygun. / Compatible with XTC-GSC Insert. / Под пластину XTC-GSC.

Sipariş Örneği/Ordering Example/Образец заказа

1 ad./pcs./шт. ADKT-H22-R-1616-(0.5-2)-T4

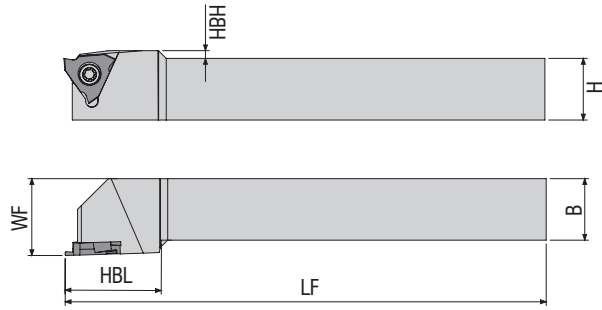
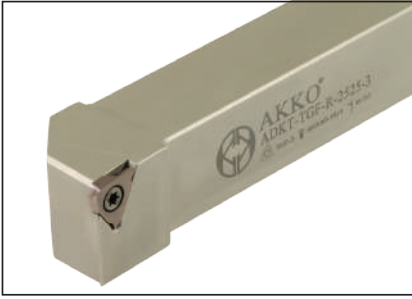

Takım Kodu Ordering Code Код для заказа	Stok Stock Наличие		Takım Ölçüleri (mm) Dimension (mm) Размеры (мм)				Kesici Uç Insert Пластина	Yedek Parçaları / Spare Parts / Запасные части			
	R	L	HF=H	B	LF	WF		Sıkma Vidası Screw Зажимной винт	Pul Stamp Шайба	Anahtar Allen Key Ключ	
ADKT-TGF-R/L-1616-3	●	○	16	16	125	20	QC16L150	4015-M3.5X10	-	80-T15	
ADKT-TGF-R/L-2020-3	●	○	20	20	125	25					
ADKT-TGF-R/L-2525-3	●	○	25	25	150	32					

NTK Ucuna Uygundur. / Compatible with NTK Insert. / Под пластину NTK.

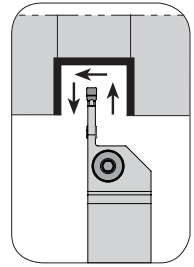
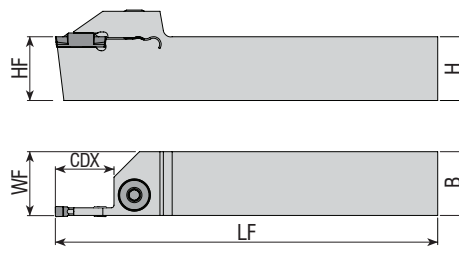

Takım Kodu Ordering Code Код для заказа	Stok Stock Наличие		Takım Ölçüleri (mm) Dimension (mm) Размеры (мм)					Kesici Uç Insert Пластина	Yedek Parçaları / Spare Parts / Запасные части			
	R	L	HF=H	B	LF	WF	CDX		Sıkma Vidası Screw Зажимной винт	Pul Stamp Шайба	Anahtar Allen Key Ключ	
ADKT-TG-R/L-1616-2-R17	●	○	16	16	125	16.2	17	DGM2-020	AKV-02-M6x22	ABPL-01	AAL-03-3	
ADKT-TG-R/L-2020-2-T8	●	○	20	20	125	20.2	8					
ADKT-TG-R/L-2020-2-R12	●	○	20	20	125	20.2	12					
ADKT-TG-R/L-2020-2-R17	●	○	20	20	125	20.2	17					
ADKT-TG-R/L-2525-2-R12	●	○	25	25	150	25.2	12					
ADKT-TG-R/L-2525-2-R17	●	○	25	25	150	25.2	17	DGM3-020	2004-M8x1x20	-	AAL-05-4	
ADKT-TG-R/L-1616-3-T20	●	○	16	16	125	16.3	20					
ADKT-TG-R/L-2020-3-T12	●	○	20	20	125	20.3	12					
ADKT-TG-R/L-2020-3-T20	●	○	20	20	125	20.3	20					
ADKT-TG-R/L-2525-3-T9	●	○	25	25	150	25.3	9					
ADKT-TG-R/L-2525-3-T20	●	○	25	25	150	25.3	20					
ADKT-TG-R/L-2525-3-R25	●	○	25	25	150	25.3	25					
ADKT-TG-R/L-2525-4-T15	●	○	25	25	150	25.5	15					
ADKT-TG-R/L-2525-4-T20	●	○	25	25	150	25.5	20					
ADKT-TG-R/L-2525-4-T25	●	○	25	25	150	25.5	25					
ADKT-TG-R/L-2525-5-T12	●	○	25	25	150	25.5	12	DGM5-030				
ADKT-TG-R/L-2525-5-T25	●	○	25	25	150	25.5	25					
ADKT-TG-R/L-2525-5-T32	●	○	25	25	150	25.5	32					

R: Sağ / Right / Правый L: Sol / Left / Левый

● Stokta / In Stock / В наличии ○ Stokta Yok / Non Stock Item / Нет в наличии
TNGLY Ucuna Uygundur. / Compatible with TNGLY Insert. / Под пластину TNGLY

Sipariş Örneği/Ordering Example/Образец заказа

1 ad./pcs./шт. ADKT-TGF-R-1616-3

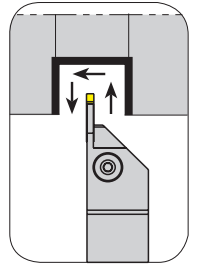
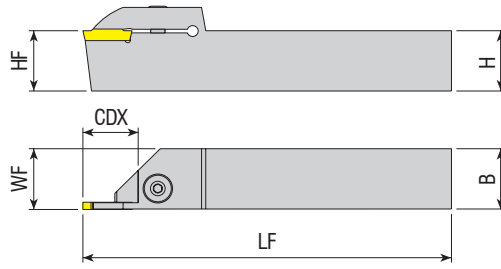

Takım Kodu Ordering Code Код для заказа	Stok Stock Наличие		Takım Ölçüleri (mm) Dimension (mm) Размеры (мм)					Kesici Uç Insert Пластина	Yedek Parçaları / Spare Parts / Запасные части		
	R	L	HF=H	B	LF	WF	CDX		Sıkma Vidası Screw Зажимной винт	Pul Stamp Шайба	Anahtar Allen Key Ключ
ADKT-WGX16-R/L-2020-2-R16	●	○	20	20	125	20.2	16	GX16. - 2	AKV-02-M6x22	ABPL-01	AAL-03-3
ADKT-WGX16-R/L-2525-2-R16	●	○	25	25	150	25.2	16				
ADKT-WGX24-R/L-2020-3-T20	●	●	20	20	125	20.4	20	GX24. - 3	2004-M8x1x20	-	AAL-05-4
ADKT-WGX24-R/L-2525-3-T12	●	●	25	25	150	25.4	12				
ADKT-WGX24-R/L-2525-3-T22	●	●	25	25	150	25.4	22				
ADKT-WGX24-R/L-3232-3-T22	●	○	32	32	170	32.4	22				
ADKT-WGX24-R/L-2525-4-T22	●	●	25	25	150	25.5	22				
ADKT-WGX24-R/L-2525-5-T25	●	●	25	25	150	25.5	25	GX24. - 4			
ADKT-WGX24-R/L-3232-5-T25	●	●	32	32	170	32.5	25	GX24. - 5			

WLTR Ucuna Uygundur. / Compatible with WLTR Insert. / Под пластину WLTR

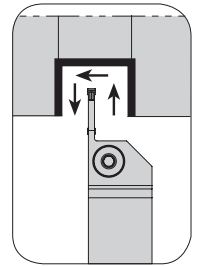
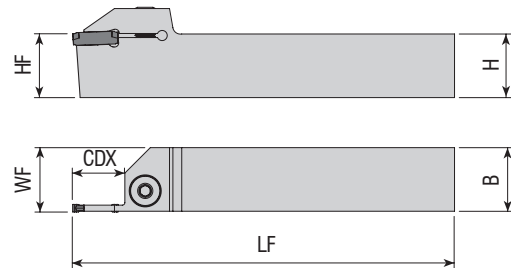

Takım Kodu Ordering Code Код для заказа	Stok Stock Наличие		Takım Ölçüleri (mm) Dimension (mm) Размеры (мм)					Kesici Uç Insert Пластина	Yedek Parçaları / Spare Parts / Запасные части		
	R	L	HF=H	B	LF	WF	CDX		Sıkma Vidası Screw Зажимной винт	Pul Stamp Шайба	Anahtar Allen Key Ключ
ADKT-GP-R/L-2020-2-T15	●	●	20	20	125	20.2	15	GP - 2	AKV-02-M6x22	ABPL-01	AAL-03-3
ADKT-GP-R/L-2525-2-T15	●	●	25	25	150	25.2	15				
ADKT-GP-R/L-2020-3-T20	●	●	20	20	125	20.3	20	GP - 3	2004-M8x1x20	-	AAL-05-4
ADKT-GP-R/L-2525-3-T22	●	●	25	25	150	25.3	22				
ADKT-GP-R/L-2525-4-T22	●	●	25	25	150	25.4	22				
ADKT-GP-R/L-2525-5-T25	●	●	25	25	150	25.5	25				
ADKT-GP-R/L-2525-5-T25	●	●	25	25	150	25.5	25				

R: Sağ / Right / Правый L: Sol / Left / Левый

● Stokta / In Stock / В наличии ○ Stokta Yok / Non Stock Item / Нет в наличии

PLBT Ucuna Uygundur. / Compatible with PLBT Insert. / Под пластину PLBT.

Sipariş Örneği/Ordering Example/Образец заказа

1 ad./pcs./шт. ADKT-WGX16-R-2020-2-R16

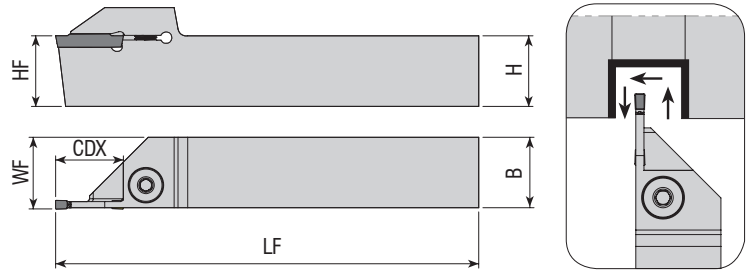

Takim Kodu
Ordering Code
Код для заказа

ADKT-CD-R/L-2020-3-R20
ADKT-CD-R/L-2525-3-R23

Stok Stock Наличие		Takim Ölçüleri (mm) Dimension (mm) Размеры (мм)					Kesici Uç Insert Пластина	Yedek Parçaları / Spare Parts / Запасные части		
R	L	HF=H	B	LF	WF	CDX		Sıkma Vidası Screw Зажимной винт	Pul Stamp Шайба	Anahtar Allen Key Ключ
●	○	20	20	125	20.3	20				
●	○	25	25	150	25.3	23	GX24 0300	2004-M8x1x20	-	AAL-05-4

CRTZT Ucuna Uygun. / Compatible with CRTZT Insert. / Под пластину CRTZT

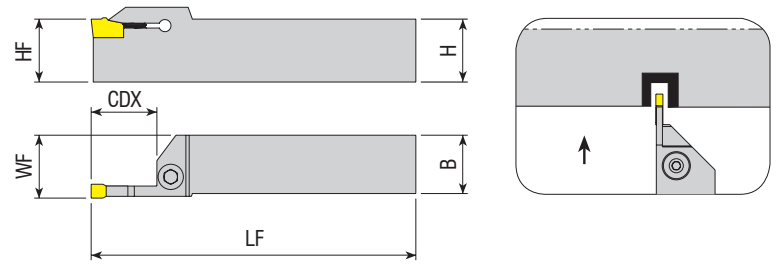

Takim Kodu
Ordering Code
Код для заказа

ADKT-SWC-R/L-2020-2-T25
ADKT-SWC-R/L-2020-3-T25

Stok Stock Наличие		Takim Ölçüleri (mm) Dimension (mm) Размеры (мм)					Kesici Uç Insert Пластина	Yedek Parçaları / Spare Parts / Запасные части		
R	L	HF=H	B	LF	WF	CDX		Sıkma Vidası Screw Зажимной винт	Pul Stamp Шайба	Anahtar Allen Key Ключ
●	○	20	20	125	20.3	25				
●	○	20	20	125	20.4	25	WCF - 3	2004-M8x1x20	-	AAL-05-4

SMTM Ucuna Uygun. / Compatible with SMTM Insert. / Под пластину SMTM.

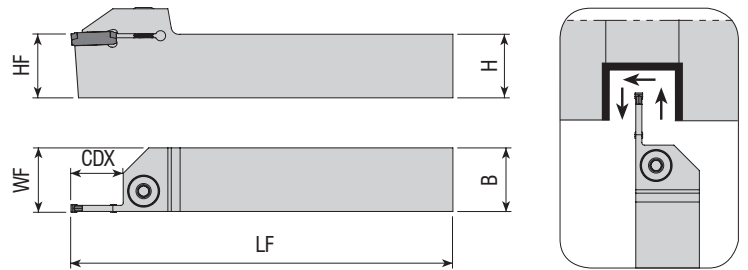

Takim Kodu
Ordering Code
Код для заказа

ADKT-GY2-R/L-2525-2-R20
ADKT-GY2-R/L-2525-3-R20
ADKT-GY2-R/L-2525-4-T25
ADKT-GY2-R/L-2525-5-T25

Stok Stock Наличие		Takim Ölçüleri (mm) Dimension (mm) Размеры (мм)					Kesici Uç Insert Пластина	Yedek Parçaları / Spare Parts / Запасные части		
R	L	HF=H	B	LF	WF	CDX		Sıkma Vidası Screw Зажимной винт	Pul Stamp Шайба	Anahtar Allen Key Ключ
●	○	25	25	150	25.2	20				
●	○	25	25	150	25.3	20	GY2M-0300	2004-M8x1x20		
●	○	25	25	150	25.4	25	GY2M-0400	2004-M8x1x20		
●	○	25	25	150	25.5	25	GY2M-0500	2004-M8x1x20	-	AAL-05-4

R: Sağ / Right / Правый L: Sol / Left / Левый

● Stokta / In Stock / В наличии ○ Stokta Yok / Non Stock Item / Нет в наличии

MTSBH Ucuna Uygun. / Compatible with MTSBH Insert. / Под пластину MTSBH.

Sipariş Örneği/Ordering Example/Образец заказа

1 ad./pcs./шт. ADKT-CD-R-2020-3-R20

DIŞ ÇAP KANAL AÇMA İSVİÇRE TİPİ KAYAR OTOMAT MAKİNA TAKIMLARI

EXTERNAL GROOVING TOOLHOLDERS FOR SWISS TYPE SLIDING AUTOMATIC LATHES

ДЕРЖАВКИ ДЛЯ ОБРАБОТКИ НАРУЖНЫХ КАНАВОК ДЛЯ ТОКАРНЫХ СТАНКОВ ШВЕЙЦАРСКОГО ТИПА

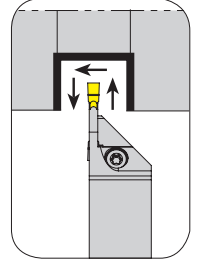
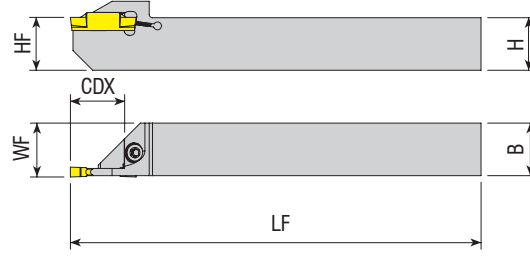

Takım Kodu
Ordering Code
Код для заказа

Stok
Stock
Наличие

R

L

HF=H

B

LF

WF

CDX

Takım Ölçüleri (mm)
Dimension (mm)
Размеры (мм)

Kesici Uç
Insert
Пластина

Yedek Parçaları / Spare Parts / Запасные части

Sıkma Vidası
Screw
Зажимной винт

Pul
Stamp
Шайба

Anahtar
Allen Key
Ключ



new ADKT-TD-R/L-1010-2-R10-K-S

●

●

10

10

125

10.2

10

TD. - 2

4015-M4x11

-

80-T15

ADKT-TD-R/L-1212-2-T12-K-S

●

●

12

12

125

12.2

12

TD. - 3

ADKT-TD-R/L-1616-2-T16-K-S

●

●

16

16

125

16.2

16

ADKT-TD-R/L-1212-3-T12-K-S

●

●

12

12

125

12.3

12

ADKT-TD-R/L-1616-3-T16-K-S

●

●

16

16

125

16.3

16

TGTC Ucuna Uygundur. / Compatible with TGTC Insert. / Под пластину TGTC.

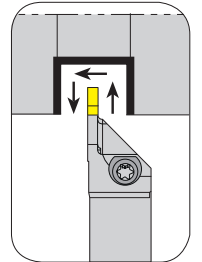
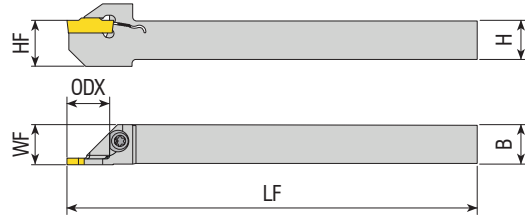

Takım Kodu
Ordering Code
Код для заказа

Stok
Stock
Наличие

R

L

HF=H

B

LF

WF

CDX

Takım Ölçüleri (mm)
Dimension (mm)
Размеры (мм)

Kesici Uç
Insert
Пластина

Yedek Parçaları / Spare Parts / Запасные части

Sıkma Vidası
Screw
Зажимной винт

Pul
Stamp
Шайба

Tork Anahtar
Torx Key
Torx Ключ



ADKT-RD-R/L-1212-2-T12-K-S

●

●

12

12

125

12.2

12

RD. - 2

4015-M4x11

-

80-T15

ADKT-RD-R/L-1616-2-T17-K-S

●

●

16

16

125

16.2

17

ADKT-RD-R/L-1212-3-T12-K-S

●

●

12

12

125

12.2

12

R: Sağ / Right / Правый L: Sol / Left / Левый

● Stokta / In Stock / В наличии ○ Stokta Yok / Non Stock Item / Нет в наличии

TGTC Ucuna Uygundur. / Compatible with TGTC Insert. / Под пластину TGTC.

Sipariş Örneği/Ordering Example/Образец заказа

1 ad./pcs./шт. ADKT-TD-R-1010-2-R10-K-S

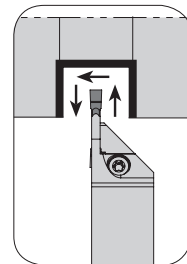
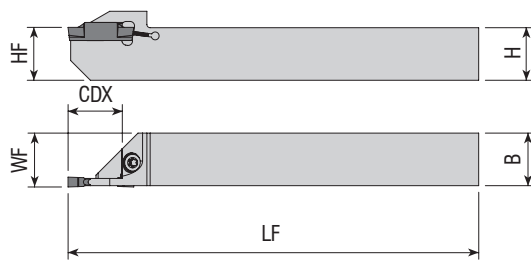

Takım Kodu Ordering Code Код для заказа	Stok Stock Наличие		Takım Ölçüleri (mm) Dimension (mm) Размеры (мм)					Kesici Uç Insert Пластина	Yedek Parçaları / Spare Parts / Запасные части		
	R	L	HF=H	B	LF	WF	CDX		Sıkma Vidası Screw Зажимной винт	Pul Stamp Шайба	Anahtar Allen Key Ключ
ADKT-ZCC2-R/L-1010-2-T12-K-S	●	●	10	10	125	10.2	12	Z.BD - 2	4015-M4x11	-	80-T15
ADKT-ZCC2-R/L-1212-2-T12-K-S	●	●	12	12	125	12.2	12				
ADKT-ZCC2-R/L-1616-2-R16-K-S	●	●	16	16	125	16.2	16	Z.FD - 3			
ADKT-ZCC2-R/L-1212-3-T12-K-S	●	●	12	12	125	12.3	12				

ZCC Ucuna Uygundur. / Compatible with ZCC Insert. / Под пластину ZCC.

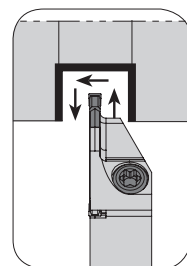
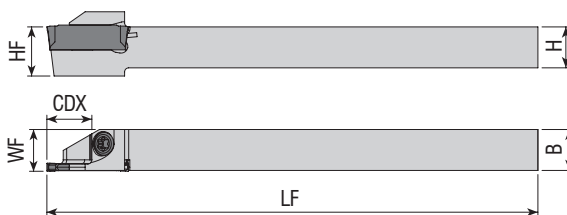

Takım Kodu Ordering Code Код для заказа	Stok Stock Наличие		Takım Ölçüleri (mm) Dimension (mm) Размеры (мм)					Kesici Uç Insert Пластина	Yedek Parçaları / Spare Parts / Запасные части		
	R	L	HF=H	B	LF	WF	CDX		Sıkma Vidası Screw Зажимной винт	Pul Stamp Шайба	Anahtar Allen Key Ключ
ADKT-I-R/L-0808-2-R10-S	●	●	08	08	100	8.2	10	DGN - 2	4015-M4x11	-	80-T15
ADKT-I-R/L-1010-2-R10-K-S	●	●	10	10	125	10.2	10				
ADKT-I-R/L-1212-2-R12-K-S	●	●	12	12	125	12.2	12	DGN - 3			
ADKT-I-R/L-1616-2-R16-K-S	●	○	16	16	125	16.2	16				
ADKT-I-R/L-1616-3-R16-K-S	●	●	16	16	125	16.3	16				

R: Sağ / Right / Правый L: Sol / Left / Левый
 ● Stokta / In Stock / В наличии ○ Stokta Yok / Non Stock Item / Нет в наличии
 ISCR Ucuna Uygundur. / Compatible with ISCR Insert. / Под пластину ISCR.

Sipariş Örneği/Ordering Example/Образец заказа
 1 ad./pcs./шт. ADKT-ZCC2-R-1010-2-T12-K-S

DIŞ ÇAP KANAL AÇMA İSVİÇRE TİPİ KAYAR OTOMAT MAKİNA TAKIMLARI
EXTERNAL GROOVING TOOLHOLDERS FOR SWISS TYPE SLIDING AUTOMATIC LATHES
ДЕРЖАВКИ ДЛЯ ОБРАБОТКИ НАРУЖНЫХ КАНАВOK ДЛЯ ТОКАРНЫХ СТАНКОВ ШВЕЙЦАРСКОГО ТИПА

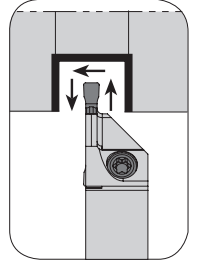
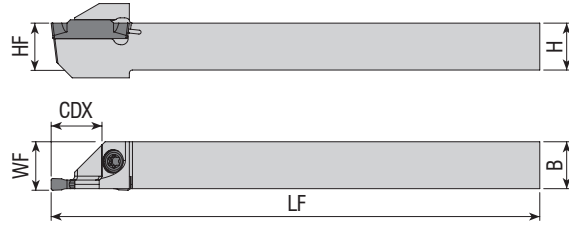

Takım Kodu Ordering Code Код для заказа	Stok Stock Наличие		Takım Ölçüleri (mm) Dimension (mm) Размеры (мм)				Kesici Uç Insert Пластина	Yedek Parçaları / Spare Parts / Запасные части			
	R	L	HF=H	B	LF	WF		CDX	Sıkma Vidası Screw Зажимной винт	Pul Stamp Шайба	Anahtar Allen Key Ключ
ADKT-KG-R/L-1212-2-R12-K-S	●	●	12	12	125	12.2	12	KG. - 2	4015-M4x11	-	80-T15
ADKT-KG-R/L-1616-2-R16-K-S	●	●	16	16	125	16.2	16				
ADKT-KG-R/L-1212-3-R12-K-S	●	●	12	12	125	12.3	12	KG. - 3	4015-M4x11	-	80-T15
ADKT-KG-R/L-1616-3-R16-K-S	●	●	16	16	125	16.3	16				

KRLY Ucuna Uygunudur. / Compatible with KRLY Insert. / Под пластину KRLY.

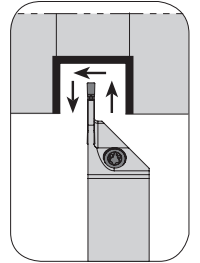
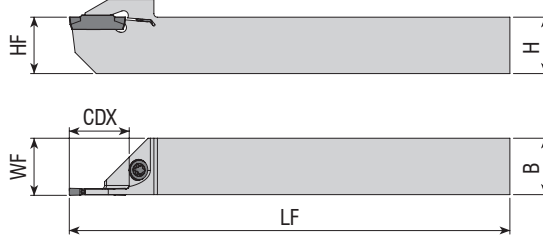

Takım Kodu Ordering Code Код для заказа	Stok Stock Наличие		Takım Ölçüleri (mm) Dimension (mm) Размеры (мм)				Kesici Uç Insert Пластина	Yedek Parçaları / Spare Parts / Запасные части			
	R	L	HF=H	B	LF	WF		CDX	Sıkma Vidası Screw Зажимной винт	Pul Stamp Шайба	Anahtar Allen Key Ключ
ADKT-K-R/L-1212-2-R12-K-S	●	●	12	12	125	12.20	12	MGM. - 2	4015-M4x11	-	80-T15
ADKT-K-R/L-1616-2-R16-K-S	●	●	16	16	125	16.20	16				
ADKT-K-R/L-1212-3-R12-K-S	●	●	12	12	125	12.30	12	MGM. - 3	4015-M4x11	-	80-T15
ADKT-K-R/L-1616-3-R16-K-S	●	●	16	16	125	16.30	16				

R: Sağ / Right / Правый L: Sol / Left / Левый
● Stokta / In Stock / В наличии ○ Stokta Yok / Non Stock Item / Нет в наличии
KRLY Ucuna Uygunudur. / Compatible with KRLY Insert. / Под пластину KRLY.

Sipariş Örneği/Ordering Example/Образец заказа
1 ad./pcs./шт. ADKT-KG-R-1212-2-R12-K-S

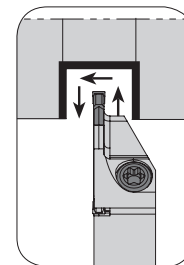
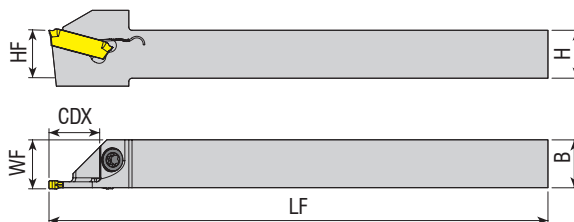

Takım Kodu Ordering Code Код для заказа	Stok Stock Наличие		Takım Ölçüleri (mm) Dimension (mm) Размеры (мм)					Kesici Uç Insert Пластина	Yedek Parçaları / Spare Parts / Запасные части		
	R	L	HF=H	B	LF	WF	CDX		Sıkma Vidası Screw Зажимной винт	Pul Stamp Шайба	Anahtar Allen Key Ключ
ADKT-WGX16-R/L-1212-2-R12-K-S	●	●	12	12	125	12.2	12	GX16. - 2	4015-M4x11	-	80-T15
ADKT-WGX16-R/L-1616-2-R16-K-S	●	○	16	16	125	16.2	16				
ADKT-WGX24-R/L-1616-3-R16-K-S	●	○	16	16	125	16.3	16				

WLTR Ucuna Uygun. / Compatible with WLTR Insert. / Под пластину WLTR

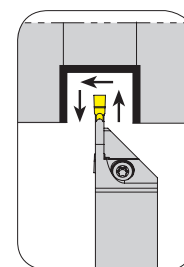
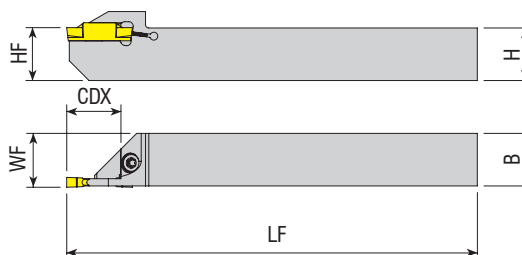

Takım Kodu Ordering Code Код для заказа	Stok Stock Наличие		Takım Ölçüleri (mm) Dimension (mm) Размеры (мм)					Kesici Uç Insert Пластина	Yedek Parçaları / Spare Parts / Запасные части		
	R	L	HF=H	B	LF	WF	CDX		Sıkma Vidası Screw Зажимной винт	Pul Stamp Шайба	Tork Anahtar Torx Key Торх Ключ
ADKT-TG-R/L-1212-2-R12-K-S	●	○	12	12	125	12.2	12	DGM2-020	4015-M4x11	-	80-T15
ADKT-TG-R/L-1212-3-R12-K-S	●	○	12	12	125	12.3	12	DGM3-020			

TNGLY Ucuna Uygun. / Compatible with TNGLY Insert. / Под пластину TNGLY

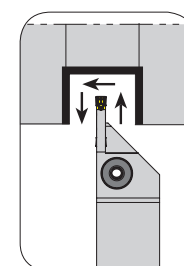
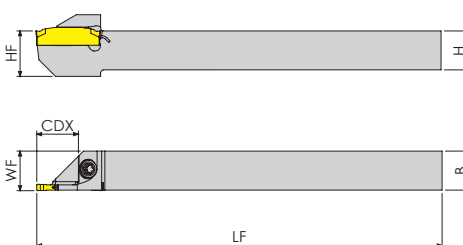

Takım Kodu Ordering Code Код для заказа	Stok Stock Наличие		Takım Ölçüleri (mm) Dimension (mm) Размеры (мм)					Kesici Uç Insert Пластина	Yedek Parçaları / Spare Parts / Запасные части		
	R	L	HF=H	B	LF	WF	CDX		Sıkma Vidası Screw Зажимной винт	Pul Stamp Шайба	Anahtar Allen Key Ключ
ADKT-123-R/L-1212-2-T12-K-S	●	○	12	12	125	12.2	12	123 - 2	4015-M4x11	-	80-T15
ADKT-123-R/L-1212-3-T12-K-S	○	○	12	12	125	12.3	12	123 - 3			

R: Sağ / Right / Правый L: Sol / Left / Левый

● Stokta / In Stock / В наличии ○ Stokta Yok / Non Stock Item / Нет в наличии

SNDVK Ucuna Uygun. / Compatible with SNDVK Insert. / Под пластину SNDVK.

Sipariş Örneği/Ordering Example/Образец заказа

1 ad./pcs./шт. ADKT-WGX16-R-1212-2-R12-K-S

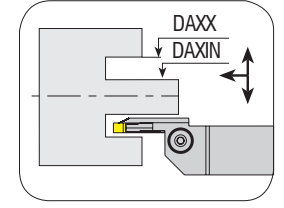
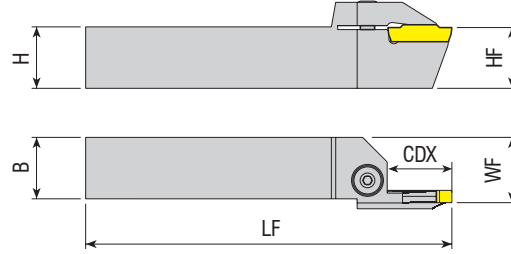

Takım Kodu Ordering Code Код для заказа	Stok Stock Наличие		Takım Ölçüleri (mm) Dimension (mm) Размеры (мм)							Kesici Uç Insert Пластина	Yedek Parçaları / Spare Parts / Запасные части		
	R	L	HF=H	B	LF	WF	CDX	DAXIN	DAXX		Sıkma Vidası Screw Зажимной винт	Pul Stamp Шайба	Anahtar Allen Key Ключ
AAKT-K-R/L-2525-34-45-3-T17	●	●	25	25	150	26.5	17	34	45	MGM. - 3			
AAKT-K-R/L-2525-39-55-3-T17	●	●	25	25	150	26.5	17	39	55				
AAKT-K-R/L-2525-49-80-3-T17	●	●	25	25	150	26.5	17	49	80				
AAKT-K-R/L-2525-70-110-3-T17	●	●	25	25	150	26.5	17	70	110				
AAKT-K-R/L-2525-100-150-3-T17	●	●	25	25	150	26.5	17	100	150				
AAKT-K-R/L-2525-80-180-3-T32	●	●	25	25	150	26.5	32	80	180				
AAKT-K-R/L-2525-175-215-3-T22	●	●	25	25	150	26.5	22	175	215				
AAKT-K-R/L-2525-700-800-3-T17	●	●	25	25	150	26.5	17	700	800				
AAKT-K-R/L-2525-50-85-4-T22	●	●	25	25	150	26.5	22	50	85	MGM. - 4	2004-M8x1x20	-	AAL-05-4
AAKT-K-R/L-2525-70-110-4-T22	●	●	25	25	150	26.5	22	70	110				
AAKT-K-R/L-2525-100-150-4-T22	●	●	25	25	150	26.5	22	100	150				
AAKT-K-R/L-2525-80-180-4-T32	●	●	25	25	150	26.5	32	80	180				
AAKT-K-R/L-2525-180-800-4-T32	●	●	25	25	150	26.5	32	180	800	MGM. - 5			
AAKT-K-R/L-2525-70-110-5-T25	●	●	25	25	150	26.5	25	70	110				
AAKT-K-R/L-2525-100-150-5-T25	●	●	25	25	150	26.5	25	100	150				
AAKT-K-R/L-2525-80-180-5-T32	●	●	25	25	150	26.5	32	80	180				
AAKT-K-R/L-2525-140-200-5-T25	●	●	25	25	150	26.5	25	140	200				
AAKT-K-R/L-2525-180-800-5-T32	●	●	25	25	150	26.5	32	180	800	MGM. - 6			
new AAKT-K-R/L-2525-180-800-5-T40	●	○	25	25	150	26.5	40	180	800				
AAKT-K-R/L-2525-60-100-6-T25	●	●	25	25	150	26.5	25	60	100				
AAKT-K-R/L-2525-60-100-6-T35	●	○	25	25	150	26.5	35	60	100	MGM. - 6			
AAKT-K-R/L-2525-100-200-6-T25	●	○	25	25	150	26.5	25	100	200				
AAKT-K-R/L-2525-100-200-6-T35	●	○	25	25	150	26.5	35	100	200				
AAKT-K-R/L-2525-100-200-6-T45	●	○	25	25	150	26.5	45	100	200	MGM. - 6			
AAKT-K-R/L-2525-140-300-6-T35	●	●	25	25	150	26.5	35	140	300				
new AAKT-K-R/L-2525-180-360-6-T40	●	○	25	25	150	26.5	40	180	360	MGM. - 8			
AAKT-K-R/L-2525-140-300-8-T35	●	○	25	25	150	26.5	35	140	300				
AAKT-K-R/L-3232-140-350-8-T35	●	○	32	32	150	33.5	35	140	350				

R: Sağ / Right / Правый L: Sol / Left / Левый
● Stokta / In Stock / В наличии ○ Stokta Yok / Non Stock Item / Нет в наличии
KRLRY Ucuna Uygunudur. / Compatible with KRLRY Insert. / Под пластину KRLRY.

Sipariş Örneği/Ordering Example/Образец заказа
1 ad./pcs./шт. AAKT-K-R-2525-34-45-3-T17

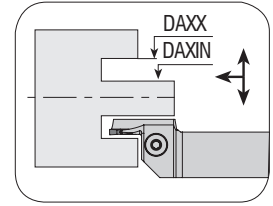
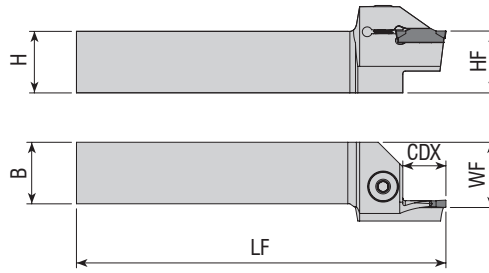

Takım Kodu
Ordering Code
Код для заказа

Takım Ölçüleri (mm)
Dimension (mm)
Размеры (мм)

Kesici Uç
Insert
Пластина

Yedek Parçaları / Spare Parts / Запасные части

Sıkma Vidası
Screw
Зажимной винт

Pul
Stamp
Шайба

Anahtar
Allen Key
Ключ

R	L	HF=H	B	LF	WF	CDX	DAXIN	DAXX	Kesici Uç Insert Пластина	Sıkma Vidası Screw Зажимной винт	Pul Stamp Шайба	Anahtar Allen Key Ключ
●	○	25	25	150	26.5	4	140	180	Z.BD - 2	2004-M8x1x20	-	AAL-05-4
●	●	25	25	150	26.5	17	35	45	Z.FD - 3			
●	○	25	25	150	26.5	17	39	55				
●	●	25	25	150	26.5	17	49	80				
●	○	25	25	150	26.5	15	70	110	Z.GD - 4			
●	●	25	25	150	26.5	17	70	110				
●	●	25	25	150	26.5	17	100	150	Z.HD - 5			
●	●	25	25	150	26.5	22	100	150				
●	○	25	25	150	26.5	22	40	60				
●	●	25	25	150	26.5	22	52	80				
●	●	25	25	150	26.5	22	72	110	Z.KD - 6			
●	○	25	25	150	26.5	22	100	150				
●	●	25	25	150	26.5	22	140	200				
●	○	25	25	150	26.5	25	55	95	Z.HD - 5			
●	●	25	25	150	26.5	25	85	140				
●	○	25	25	150	26.5	25	130	200	Z.KD - 6			
●	●	25	25	150	26.5	25	190	400				
●	○	25	25	150	26.5	35	190	400				
●	●	25	25	150	26.5	17	200	500	Z.KD - 6			
●	○	25	25	150	26.5	15	60	110				
●	○	32	32	170	33.5	25	160	400	Z.KD - 6			

ZCC Ucuna Uygundur. / Compatible with ZCC Insert. / Под пластину ZCC.

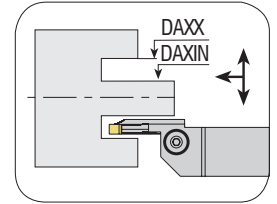
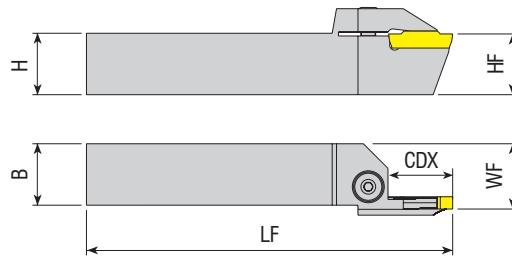

Takım Kodu
Ordering Code
Код для заказа

Stok
Stock
Наличие

Takım Ölçüleri (mm)
Dimension (mm)
Размеры (мм)

Kesici Uç
Insert
Пластина

Yedek Parçaları / Spare Parts / Запасные части

Sıkma Vidası
Screw
Зажимной винт

Pul
Stamp
Шайба

Anahtar
Allen Key
Ключ

R	L	HF=H	B	LF	WF	CDX	DAXIN	DAXX	Kesici Uç Insert Пластина	Sıkma Vidası Screw Зажимной винт	Pul Stamp Шайба	Anahtar Allen Key Ключ
○	○	25	25	150	26.5	22	44	70	KG. - 4	2004-M8x1x20	-	AAL-05-4
○	○	25	25	150	26.5	22	60	120				
○	○	25	25	150	26.5	22	112	200				

R: Sağ / Right / Правый L: Sol / Left / Левый

● Stokta / In Stock / В наличии ○ Stokta Yok / Non Stock Item / Нет в наличии

KRLY Ucuna Uygundur. / Compatible with KRLY Insert. / Под пластину KRLY.

Sipariş Örneği/Ordering Example/Образец заказа
1 ad./pcs./шт. AAKT-ZCC2-R-2525-140-180-2-T4

DIŞ ÇAP ALIN KANAL AÇMA TAKIMLARI
FACE EXTERNAL GROOVING TOOLHOLDERS
ДЕРЖАВКИ ДЛЯ ОБРАБОТКИ ТОРЦЕВЫХ КАНАВОК

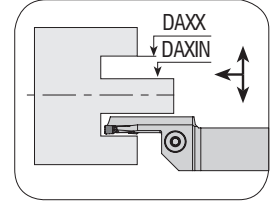
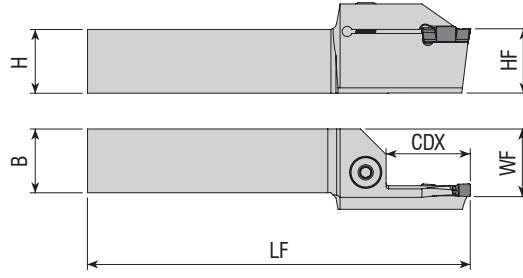

Takım Kodu Ordering Code Код для заказа	Stok Stock Наличие		Takım Ölçüleri (mm) Dimension (mm) Размеры (мм)							Kesici Uç Insert Пластина	Yedek Parçaları / Spare Parts / Запасные части		
	R	L	HF=H	B	LF	WF	CDX	DAXIN	DAXX		Sıkma Vidası Screw Зажимной винт	Pul Stamp Шайба	Anahtar Allen Key Ключ
AAKT-IG-R/L-2525-40-60-4-T25	●	●	25	25	150	26.5	25	40	60	DGN / GRP - 4	2004-M8x1x20	-	AAL-05-4
AAKT-IG-R/L-2525-52-80-4-T25	●	●	25	25	150	26.5	25	52	80				
AAKT-IG-R/L-2525-70-110-4-T28	●	●	25	25	150	26.5	28	70	110				
AAKT-IG-R/L-2525-72-110-4-T25	○	○	25	25	150	26.5	25	72	110				
AAKT-IG-R/L-2525-100-150-4-T25	●	○	25	25	150	26.5	25	100	150				
AAKT-IG-R/L-2525-110-200-4-T28	●	○	25	25	150	26.5	28	110	200				
AAKT-IG-R/L-2525-110-200-4-T32	●	●	25	25	150	26.5	32	110	200				
AAKT-IG-R/L-2525-140-200-4-T25	○	○	25	25	150	26.5	25	140	200				
AAKT-IG-R/L-2525-180-800-4-T28	●	●	25	25	150	26.5	28	180	800				
AAKT-IG-R/L-2525-200-800-4-T25	○	○	25	25	150	26.5	25	200	800				
AAKT-IG-R/L-2525-70-110-5-T32	●	●	25	25	150	26.5	32	70	110	DGN / GRP - 5			
AAKT-IG-R/L-2525-110-200-5-T9	●	○	25	25	150	26.5	9	110	200				
AAKT-IG-R/L-2525-110-200-5-T32	●	●	25	25	150	26.5	32	110	200				
AAKT-IG-R/L-2525-180-800-5-T32	●	●	25	25	150	26.5	32	180	800	DGN / GRP - 6			
AAKT-IG-R/L-2525-58-100-6-T32	●	○	25	25	150	26.5	32	58	100				
AAKT-IG-R/L-2525-88-180-6-T32	●	○	25	25	150	26.5	32	88	180				

ISCR Ucuna Uygundur. / Compatible with ISCR Insert. / Под пластину ISCR.

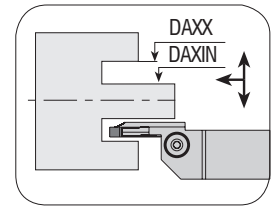
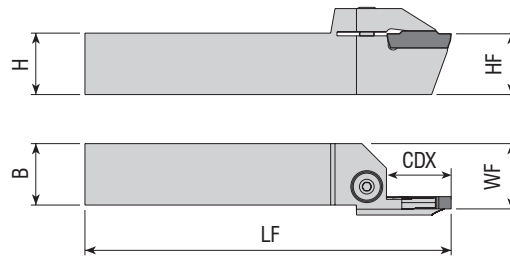

Takım Kodu Ordering Code Код для заказа	Stok Stock Наличие		Takım Ölçüleri (mm) Dimension (mm) Размеры (мм)							Kesici Uç Insert Пластина	Yedek Parçaları / Spare Parts / Запасные части		
	R	L	HF=H	B	LF	WF	CDX	DAXIN	DAXX		Sıkma Vidası Screw Зажимной винт	Pul Stamp Шайба	Anahtar Allen Key Ключ
AAKT-SGC-R/L-2020-22-53-3-T13	○	●	20	20	125	21.5	13	22	53	GCM N3002 GCM N4020	2004-M8X1X20	-	AAL-05-4
AAKT-SGC-R/L-2525-80-100-3-T8	●	○	25	25	150	26.5	8	80	100				
AAKT-SGC-R/L-2525-40-65-4-T12	●	○	25	25	150	26.5	12	40	65				
AAKT-SGC-R/L-2525-80-140-4-T8	●	○	25	25	150	26.5	8	80	140				

R: Sağ / Right / Правый L: Sol / Left / Левый

● Stokta / In Stock / В наличии ○ Stokta Yok / Non Stock Item / Нет в наличии

SMTM Ucuna Uygundur. / Compatible with SMTM Insert. / Под пластину SMTM.

Sipariş Örneği/Ordering Example/Образец заказа
1 ad./pcs./шт. AAKT-IG-R-2525-40-60-4-T25

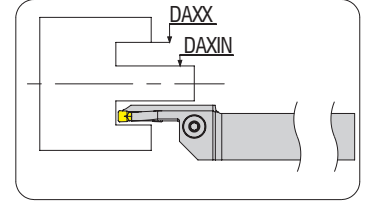
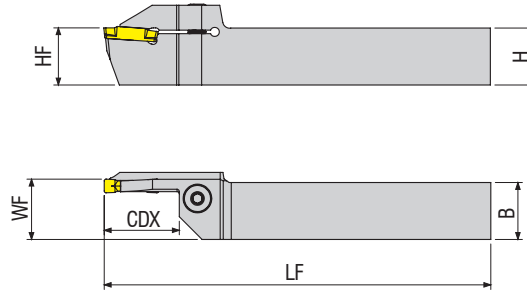
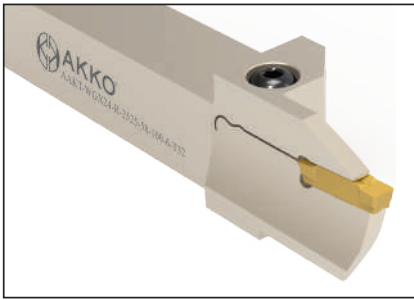

Takım Kodu Ordering Code Код для заказа	Stok Stock Наличие		Takım Ölçüleri (mm) Dimension (mm) Размеры (мм)							Kesici Uç Insert Пластина	Yedek Parçaları / Spare Parts / Запасные части		
	R	L	HF=H	B	LF	WF	CDX	DAXIN	DAXX		Sıkma Vidası Screw Зажимной винт	Pul Stamp Шайба	Anahtar Allen Key Ключ
AAKT-WGX24-R-L-2525-58-100-6-T32	●	○	25	25	170	26.5	32	58	100	GX24-6	2004-M8x1x20	-	AAL-05-4
AAKT-WGX24-R-L-2525-88-180-6-T32	●	○	25	25	170	26.5	32	88	180				

WLTR Ucuna Uygunudur. / Compatible with WLTR Insert. / Под пластину WLTR.

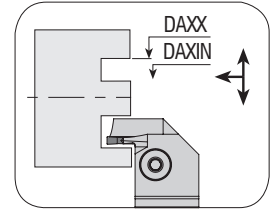
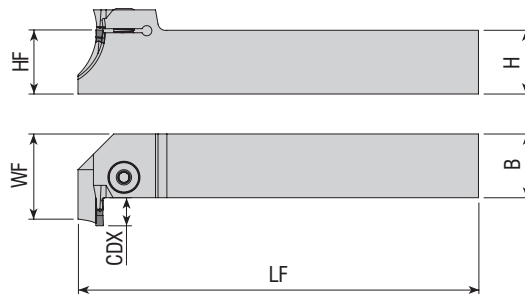

Takım Kodu Ordering Code Код для заказа	Stok Stock Наличие		Takım Ölçüleri (mm) Dimension (mm) Размеры (мм)							Kesici Uç Insert Пластина	Yedek Parçaları / Spare Parts / Запасные части		
	R	L	HF=H	B	LF	WF	CDX	DAXIN	DAXX		Sıkma Vidası Screw Зажимной винт	Pul Stamp Шайба	Anahtar Allen Key Ключ
ALKT-ZCC2-R/L-2525-35-45-3-T10	●	●	25	25	150	36	10	35	45	Z.FD - 3	2004-M8x1x20	-	AAL-05-4
ALKT-ZCC2-R/L-2525-39-55-3-T10	●	●	25	25	150	36	10	39	55				
ALKT-ZCC2-R/L-2525-35-∞-3-T4	●	●	25	25	150	30	4	35	∞	Z.GD - 4	2004-M8x1x20	-	AAL-05-4
ALKT-ZCC2-R/L-2525-40-60-4-T14	●	●	25	25	150	40	14	40	60				
ALKT-ZCC2-R/L-2525-52-80-4-T14	●	○	25	25	150	40	14	52	80	Z.GD - 4	2004-M8x1x20	-	AAL-05-4
ALKT-ZCC2-R/L-2525-72-110-4-T14	●	○	25	25	150	40	14	72	110				
ALKT-ZCC2-R/L-2525-100-230-4-T14	●	○	25	25	150	40	14	100	230	Z.GD - 4	2004-M8x1x20	-	AAL-05-4
ALKT-ZCC2-R/L-2525-40-∞-4-T4	●	●	25	25	150	30	4	40	∞				

R: Sağ / Right / Правый L: Sol / Left / Левый
● Stokta / In Stock / В наличии ○ Stokta Yok / Non Stock Item / Нет в наличии
ZCC Ucuna Uygunudur. / Compatible with ZCC Insert. / Под пластину ZCC.

Sipariş Örneği/Ordering Example/Образец заказа
1 ad./pcs./шт. AAKT-WGX24-R-2525-58-100-6-T32

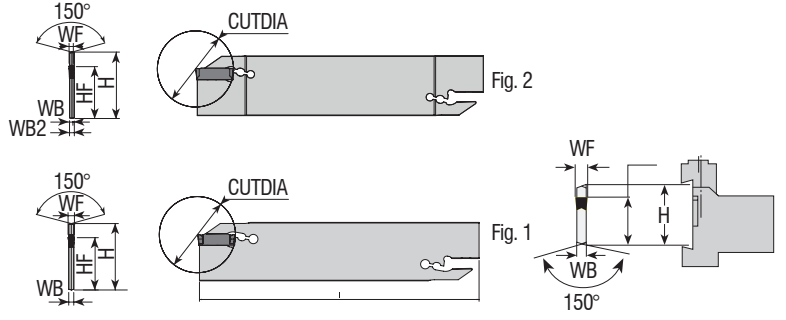
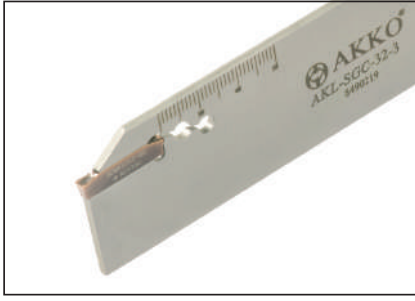

Takım Kodu Ordering Code Код для заказа	Stok Stock Наличие	Takım Ölçüleri (mm) Dimension (mm) Размеры (мм)								Kesici Uç Insert Пластина	Yedek Parçaları / Spare Parts Запасные части
		H	WF	WB2	WB	I	HF	CUTDIA	Fig.		Anahtar Allen Key Ключ
AKL-SGC-26-3	●	26	3	2.40	-	110	21.4	39	2		
AKL-SGC-32-3	●	32	3	2.40	-	150	25	39	1		

SMTM Ucuna Uygundur. / Compatible with SMTM Insert. / Под пластину SMTM.

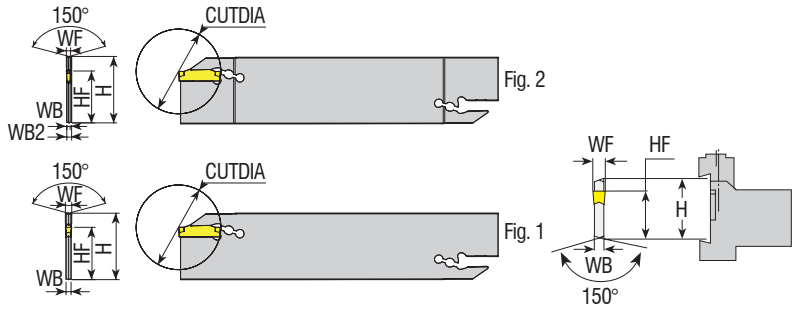

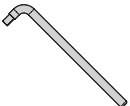
Takım Kodu Ordering Code Код для заказа	Stok Stock Наличие	Takım Ölçüleri (mm) Dimension (mm) Размеры (мм)								Kesici Uç Insert Пластина	Yedek Parçaları / Spare Parts Запасные части
		H	WF	WB2	WB	I	HF	CUTDIA	Fig.		Anahtar Allen Key Ключ
AKL-TD-32-2	●	32	2	2.4	1.6	150	25	39	2		
AKL-TD-26-3	●	26	3	-	2.40	150	26	40	1		
AKL-TD-32-3	●	32	3	2.4	-	150	25	39	1	TD. - 3	
AKL-TD-26-4	●	26	4	-	3.20	150	26	40	1	TD. - 4	
AKL-TD-32-5	●	32	5	-	4	150	25	40	1	TD. - 5	

R: Sağ / Right / Правый L: Sol / Left / Левый
 ● Stokta / In Stock / В наличии ○ Stokta Yok / Non Stock Item / Нет в наличии
 TGTC Ucuna Uygundur. / Compatible with TGTC Insert. / Под пластину TGTC.

Sipariş Örneği/Ordering Example/Образец заказа
 1 ad./pcs./шт. AKL-SGC-26-3

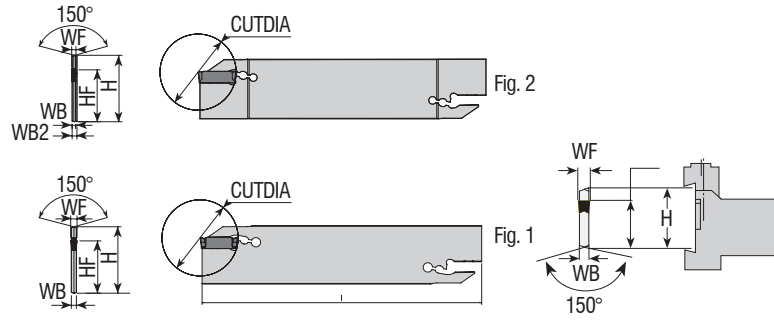
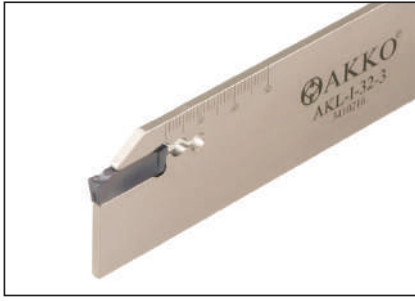

Takım Kodu Ordering Code Код для заказа	Stok Stock Наличие	Takım Ölçüleri (mm) Dimension (mm) Размеры (мм)								Kesici Uç Insert Пластина	Yedek Parçaları / Spare Parts Залпасные части	
		H	WF	WB2	WB	I	HF	CUTDIA	Fig.		Anahtar Allen Key Ключ	
AKL-I-26-2	●	26	1.9-2.5	1.6	-	110	21.4	39	1	DGN - 2	ALA-02	
AKL-I-32-2	●	32	1.9-2.5	1.6	2.4	150	25	39	2			
AKL-I-26-3	●	26	3-3.18	2.4	-	110	21.4	39	1	DGN - 3	ALA-02	
AKL-I-32-3	●	32	3-3.18	2.4	-	150	25	39	1			
AKL-I-26-4	●	26	4	3.2	-	110	21.4	80	1	DGN / GRP - 4	ALA-02	
AKL-I-32-4	●	32	4	3.2	-	150	25	100	1			

ISCR Ucuna Uygun. / Compatible with ISCR Insert. / Под пластину ISCR.

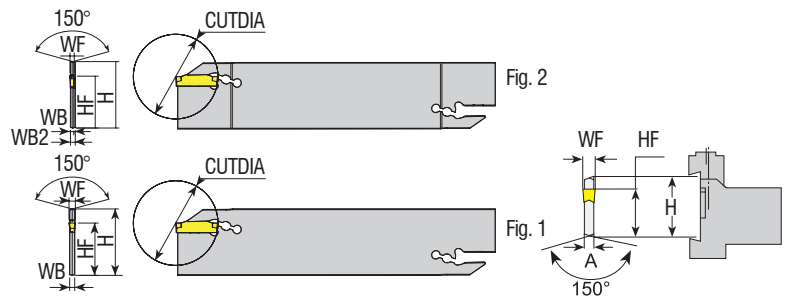

Takım Kodu Ordering Code Код для заказа	Stok Stock Наличие	Takım Ölçüleri (mm) Dimension (mm) Размеры (мм)								Kesici Uç Insert Пластина	Yedek Parçaları / Spare Parts Залпасные части	
		H	WF	WB2	WB	I	HF	CUTDIA	Fig.		Anahtar Allen Key Ключ	
AKL-123-32-2	●	32	2	2.4	1.6	150	25	39	2	123 - 2 123 - 3 123 - 4	ALA-02	
AKL-123-32-3	●	32	3	2.4	-	150	25	39	1			
AKL-123-32-4	●	32	4	3.2	-	150	25	39	1			

R: Sağ / Right / Правый L: Sol / Left / Левый

● Stokta / In Stock / В наличии ○ Stokta Yok / Non Stock Item / Нет в наличии

SNDVK Ucuna Uygun. / Compatible with SNDVK Insert. / Под пластину SNDVK.

Sipariş Örneği/Ordering Example/Образец заказа

1 ad./pcs./шт. AKL-I-26-2

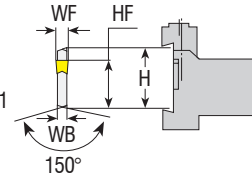
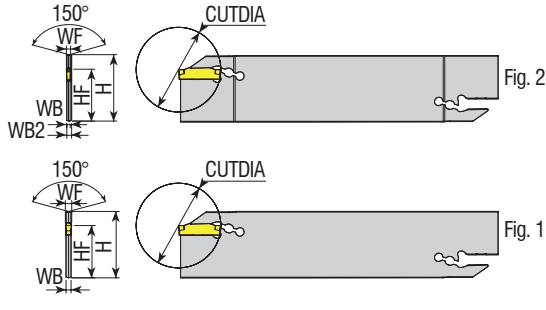
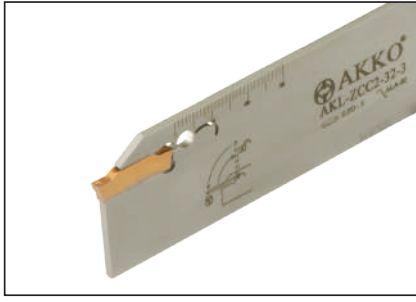

Takım Kodu Ordering Code Код для заказа	Stok Stock Наличие	Takım Ölçüleri (mm) Dimension (mm) Размеры (мм)								Kesici Uç Insert Пластина	Yedek Parçaları / Spare Parts Запасные части
		H	WF	WB2	WB	I	HF	CUTDIA	Fig.		Anahtar Allen Key Ключ
AKL-ZCC2-32-3	●	32	3	-	2.40	150	25	39	1	Z.FD-3	ALA-02
AKL-ZCC2-32-4	●	32	4	-	3.20	150	25	50.8	1	Z.FD-4	
AKL-ZCC2-32-5	●	32	5	-	4	150	25	50.8	1	Z.FD-5	

ZCC Ucuna Uygundur. / Compatible with ZCC Insert. / Под пластину ZCC.

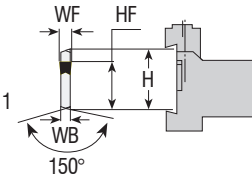
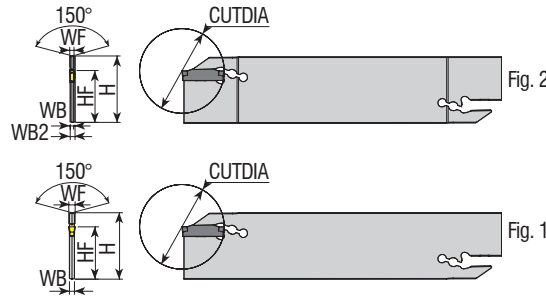

Takım Kodu Ordering Code Код для заказа	Stok Stock Наличие	Takım Ölçüleri (mm) Dimension (mm) Размеры (мм)								Kesici Uç Insert Пластина	Yedek Parçaları / Spare Parts Запасные части
		H	WF	WB2	WB	I	HF	CUTDIA	Fig.		Anahtar Allen Key Ключ
AKL-K-32-2	●	32	2	2.40	1.60	150	25	32	2	MGM.-2	ALA-02
AKL-K-32-3	●	32	3	-	2.40	150	25	42	1	MGM.-3	
AKL-K-32-4	●	32	4	-	3.20	150	25	42	1	MGM.-4	

R: Sağ / Right / Правый L: Sol / Left / Левый
 ● Stokta / In Stock / В наличии ○ Stokta Yok / Non Stock Item / Нет в наличии
 KRLY Ucuna Uygundur. / Compatible with KRLY Insert. / Под пластину KRLY.

Sipariş Örneği/Ordering Example/Образец заказа
 1 ad./pcs./шт. AKL-ZCC2-32-3



new

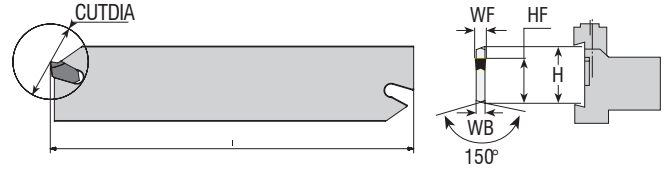
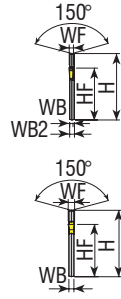
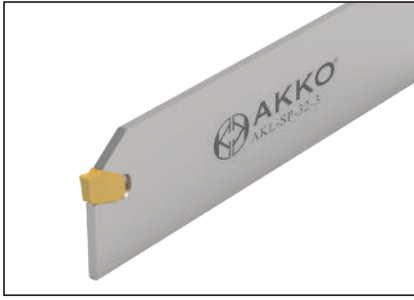

Takım Kodu Ordering Code Код для заказа	Stok Stock Наличие	Takım Ölçüleri (mm) Dimension (mm) Размеры (мм)								Kesici Uç Insert Пластина	Yedek Parçaları / Spare Parts Запасные части	
		H	WF	WB2	WB	I	HF	CUTDIA	Fig.		Anahtar Allen Key Ключ	
AKL-SP-26-2	●	26	2	-	1.60	150	21	-	1	SP200N	ALA-03	
AKL-SP-26-3	●	26	3	-	2.40	150	21	-	1	SP300N		
AKL-SP-32-3	●	32	3	-	2.40	150	25	-	1	SP300N		
AKL-SP-32-4	●	32	4	-	3.20	150	25	-	1	SP400N		

KRLY Ucuna Uygun. / Compatible with KRLY Insert. / Под пластину KRLY.

new

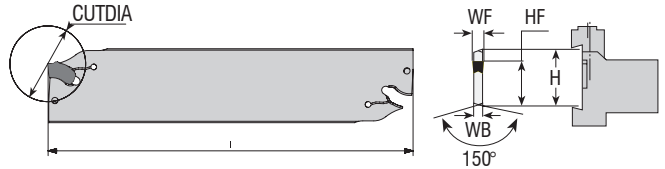
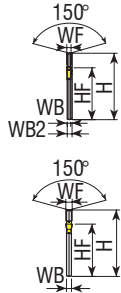

Takım Kodu Ordering Code Код для заказа	Stok Stock Наличие	Takım Ölçüleri (mm) Dimension (mm) Размеры (мм)								Kesici Uç Insert Пластина	Yedek Parçaları / Spare Parts Запасные части	
		H	WF	WB2	WB	I	HF	CUTDIA	Fig.		Anahtar Allen Key Ключ	
AKL-SX-32-3	●	32	3	-	2.40	150	24.50	-	2	SX-3E.300N	ALA-04	
AKL-SX-32-4	●	32	4	-	3.40	150	24.50	-	2	SX-4E.400N		
AKL-SX-32-5	●	32	5	-	4.30	150	24.40	-	2	SX-5E.500N		
AKL-SX-32-6	●	32	6	-	5.30	150	24.30	-	2	SX-5E.600N		

R: Sağ / Right / Правый L: Sol / Left / Левый

● Stokta / In Stock / В наличии ○ Stokta Yok / Non Stock Item / Нет в наличии
WLTR Ucuna Uygun. / Compatible with WLTR Insert. / Под пластину WLTR.

Sipariş Örneği/Ordering Example/Образец заказа

1 ad./pcs./шт. AKL-SP-26-2

KESME VE DERİN KANAL AÇMA LAMA BLOĞU
BLOCKS FOR PARTING AND DEEP GROOVING BLADES
БЛОКИ К СМЕННЫМ НОЖАМ ДЛЯ ОТРЕЗКИ И ОБРАБОТКИ ГЛУБОКИХ КАНАВОК

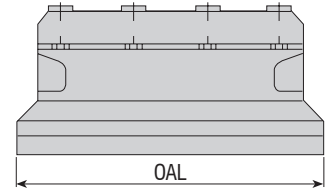
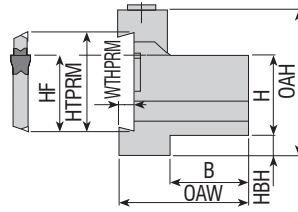

Takım Kodu Ordering Code Код для заказа	Stok Stock Наличие	Takım Ölçüleri (mm) Dimension (mm) Размеры (мм)									Yedek Parçaları / Spare Parts / Запасные части		
		HTPRM	HF	H	HBH	OAH	WTHPRM	OAL	B	OAW	Pabuç Clamp Spannspratze	Pabuç Vidası Clamp Screw Зажимной винт	Anahtar Allen Key Ключ
ALBU-20-26	●	26	21.4	20	9	43	4	86	19	38	ABK-01	2505-M6x25	AAL-07-5
ALBU-25-26	●	26	21.4	25	5	45	4	110	23	42	ABK-02	2505-M6x30	
ALBU-20-32	●	32	25	20	13	50	5.3	100	19	38	ABK-03		
ALBU-25-32	●	32	25	25	8	50	5.3	110	23	42	ABK-04		
ALBU-32-32	●	32	25	32	5	54	5.3	110	29	48			

İÇTEN SU VERME KANALLI KESME VE DERİN KANAL AÇMA LAMA BLOĞU
BLOCK FOR PARTING&GROOVING TOOLS WITH INTERNAL COOLANT HOLE
БЛОКИ СОЖ К СМЕННЫМ НОЖАМ ДЛЯ ОТРЕЗКИ И ОБРАБОТКИ ГЛУБОКИХ КАНАВОК

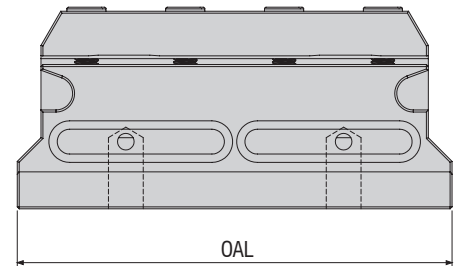
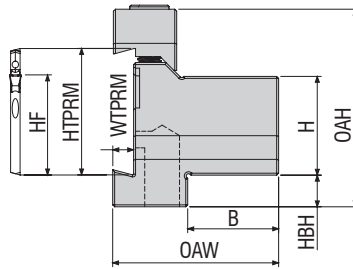

Takım Kodu Ordering Code Код для заказа	Stok Stock Наличие	Takım Ölçüleri (mm) Dimension (mm) Размеры (мм)									Yedek Parçaları / Spare Parts / Запасные части				
		HTPRM	HD	H	HBH	AOH	WTHPRM	OAL	B	OAW	Pabuç Clamp Spannspratze	Anello Ring Кольцо	Perno Filettato Threaded Pin Резьбовой Винт	Pabuç Vidası Clamp Screw Klemmschraube	Anahtar Allen Key Ключ
ALBU-20-32-H	●	32	20	20	13	36.50	5.30	100	19	38	ABK-03	AOR-43	2705-G1/8x5.5	2505-M6x30	AAL-07-5
ALBU-25-32-H	●	32	25	25	8	50	5.30	110	23	42	ABK-04	AOR-46			
ALBU-32-32-H	●	32	32	32	5	40.50	5.30	110	29	48	ABK-04				

R: Sağ / Right / Правый L: Sol / Left / Левый
 ● Stokta / In Stock / В наличии ○ Stokta Yok / Non Stock Item / Нет в наличии

Sipariş Örneği/Ordering Example/Образец заказа
 1 ad./pcs./шт. ALBU-20-26

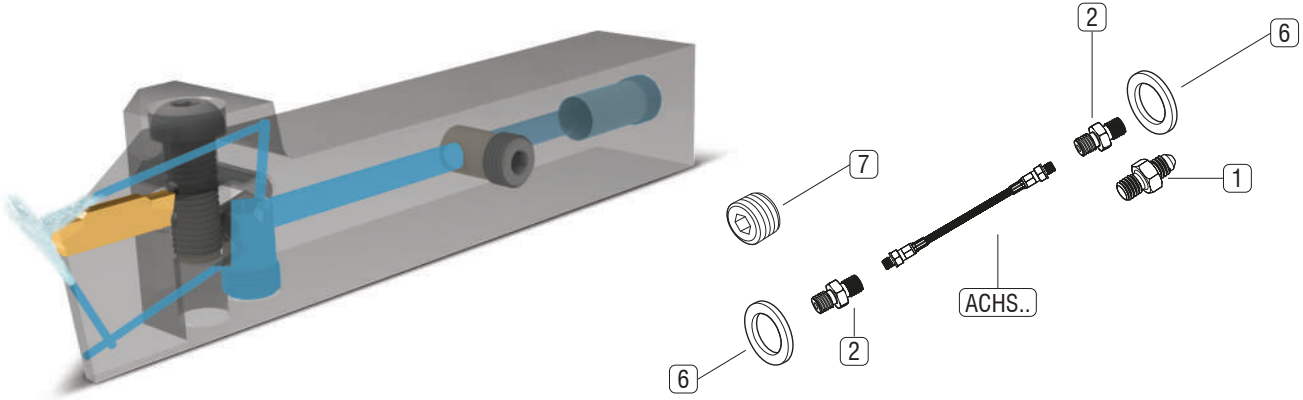

Not: İçten soğutmalı tüm torna katerlerinde kullanılabilir. 3 tip soğutma hortum setleri tasarlanmıştır. Takımların kullanılmasından önce, kullanılmayan bağlantıların set içindeki vida ile kapatılarak sızdırmazlığın sağlanmasına dikkat edilmelidir. Torna katerlerine yönelik soğutma hortum setleri, ACHS... 10 bar ile maksimum 150 bar basınç aralığında kullanılabilir.

Note: 3 types of cooling hose sets are designed that can be used in all internally cooled lathes. Before using the tools, care should be taken to ensure that the unused connections are closed with the screw in the set and that sealing is ensured. Cooling hose sets for lathe tools can be used in the pressure range of ACHS ... 10 bar to max 150 bar.

Примечание: Предлагается 3 типа комплектов трубок для подвода СОЖ. Они могут использоваться на всех токарных станках оснащенных системой подвода СОЖ. Перед началом работ необходимо закрыть неиспользуемые соединения винтом из набора и обеспечить герметичность системы подвода СОЖ. Комплекты охлаждающих трубок, для токарных инструментов, могут использоваться в диапазоне давлений ACHS от 10 бар до 150 бар.

Set İçindeki Parçalar Parts In The Set Запчасти в Наборе				Uzunluk / Length Code / Длина: 250		
				Set Kodu: Set Code: Код Набора: ACHS-1-250	Set Kodu: Set Code: Код Набора: ACHS-2-250	Set Kodu: Set Code: Код Набора: ACHS-3-250
	Resim Picture Рисунок	Takım Kodu Set Code Код Набора	Ürün Açıklaması Product Description Описание товара			
1		AMP-01	M10 Bağlantı Elemanı M10 Fastener Застежка M10	1x	-	-
2		AMP-02	G 1/8" Çift Bağlantı Elemanı G 1/8" Double Fastener G 1/8" двойная застежка	2x	1x	-
3		AMP-03	G 1/8" Açılı Bağlantısı G 1/8" Angle Connection G 1/8" угловое соединение	-	1x	2x
4		AMP-04	M10" Açılı Bağlantısı M10" Angle Connection M10" угловое соединение	-	1x	1x
5		AMP-05	G1/4"-G1/8" Kılcalma Parçası G1 / 4"-G1/8" Capillary Piece G1 / 4"-G1/8" Капиллярная часть	-	1x	1x
6		AG-01	Bakır Conta Copper Gasket Медная прокладка	2x	3x	4x
7		2705-G1/8-5.5	G1/8" Sızdırmaz Civata G1/8" Sealing Bolt G1/8" Уплотнительный болт	1x	1x	1x
8		AH-1-250	Hortum Hose Трубка	1x	-	-
9		AH-2-250	Hortum Hose Трубка	-	1x	-
10		AH-3-250	Hortum Hose Трубка	-	-	1x

konuşulan
the spoken kalite...
quality...



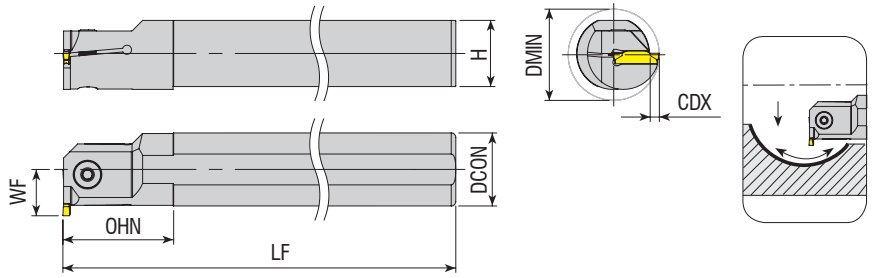

Takım Kodu Ordering Code Код для заказа	Stok Stock Наличие		Takım Ölçüleri (mm) Dimension (mm) Размеры (мм)							Kesici Uç Insert Пластина	Yedek Parçaları / Spare Parts / Запасные части	
	R	L	DCON	DMIN	LF	OHN	CDX	H	WF		Sıkma Vidası Screw Зажимной винт	Anahtar Allen Key Ключ
AIKT-K-R/L-16-2-T4	●	●	16	21	150	28	4	14.8	12	MGM. - 2	2503-M4x10	AAL-03-3
AIKT-K-R/L-20-2-T4	●	●	20	25	170	30	4	18.3	14		2503-M4x12	
AIKT-K-R/L-25-2-T6	●	●	25	32	200	40	6	23	18.5		2504-M5x12	
AIKT-K-R/L-20-3-T6	●	●	20	27	170	30	6	18.3	16	MGM. - 3	2504-M5x12	AAL-05-4
AIKT-K-R/L-20-3-T7	●	●	20	25	170	38	7	18.3	13		2504-M5x16	
AIKT-K-R/L-25-3-T6	●	●	25	32	200	40	6	23	18.5		2004-M8x1x20	
AIKT-K-R/L-25-3-T10	●	●	25	32	200	48	10	23	17		2504-M5x16	
AIKT-K-R/L-32-3-T6	●	●	32	39	250	50	6	30	22		2504-M5x12	
AIKT-K-R/L-32-3-T12	●	●	32	39	250	53	12	30	22		2504-M5x16	
AIKT-K-R/L-40-3-T6	●	●	40	47	300	55	6	37.5	26		2004-M8x1x20	
AIKT-K-R/L-40-3-T12	●	○	40	48	300	63	12	37.5	27		2504-M5x16	
AIKT-K-R/L-20-4-T6	●	●	20	27	170	30	6	18.3	16		2504-M5x16	
AIKT-K-R/L-20-4-T7	●	○	20	25	170	38	7	18.3	13		2004-M8x1x20	
AIKT-K-R/L-25-4-T6	●	●	25	32	200	40	6	23	18.5	MGM. - 4	AAL-05-4	
AIKT-K-R/L-25-4-T10	●	●	25	32	200	49	10	23	17			2504-M5x16
AIKT-K-R/L-32-4-T6	●	●	32	39	250	50	6	30	22			2004-M8x1x20
AIKT-K-R/L-32-4-T12	●	●	32	39	250	53	12	30	22			2504-M5x16
AIKT-K-R/L-40-4-T6	●	●	40	47	300	55	6	37.5	26			2004-M8x1x20
AIKT-K-R/L-40-4-T12	●	●	40	48	300	63	12	37.5	27	MGM. - 5	AAL-05-4	
AIKT-K-R/L-25-5-T7	●	●	25	33	200	40	7	23	19.5			2504-M5x16
AIKT-K-R/L-32-5-T7	●	●	32	40	250	50	7	30	23			2004-M8x1x20
AIKT-K-R/L-40-5-T7	●	●	40	48	300	55	7	37.5	27			2504-M5x16
AIKT-K-R/L-40-5-T12	●	○	40	48	300	63	12	37.5	27			2004-M8x1x20

R: Sağ / Right / Правый L: Sol / Left / Левый
● Stokta / In Stock / В наличии ○ Stokta Yok / Non Stock Item / Нет в наличии
KRLY Uçuna Uygundur. / Compatible with KRLY Insert. / Под пластину KRLY.

Sipariş Örneği/Ordering Example/Образец заказа
1 ad./pcs./шт. AIKT-K-R-16-2-T4

DELİK İÇİ KANAL KATERLERİ
INTERNAL GROOVING TOOLHOLDERS
ДЕРЖАВКИ ДЛЯ ОБРАБОТКИ ВНУТРЕННИХ КАНАВOK

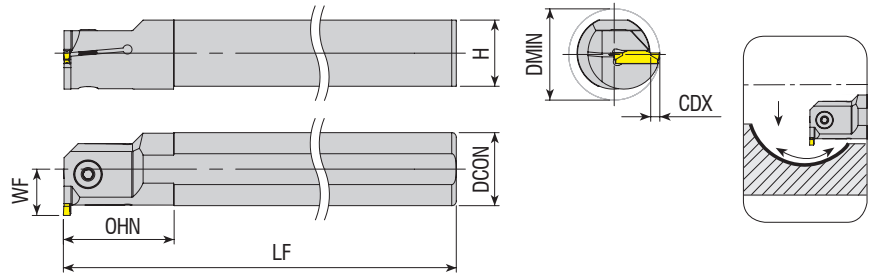

Takım Kodu Ordering Code Код для заказа	Stok Stock Наличие		Takım Ölçüleri (mm) Dimension (mm) Размеры (мм)							Kesici Uç Insert Пластина	Yedek Parçaları / Spare Parts / Запасные части	
	R	L	DCON	DMIN	LF	OHN	CDX	H	WF		Sıkma Vidası Screw Зажимной винт	Anahtar Allen Key Ключ
AIKT-KG-R/L-25-2-T7	●	●	25	33	200	40	7	23	19.5	KG.. - 2	2504-M5x12	AAL-05-4
AIKT-KG-R/L-20-3-T6.5-H	●	○	20	27.5	170	30	6.5	18.3	16.5		2504-M5x16	
AIKT-KG-R/L-25-3-T7	○	○	25	33	200	40	7	23	19.5	KG.. - 3	2004-M8x1x20	
AIKT-KG-R/L-40-3-T8	●	○	40	50	300	55	8	37.5	28		2504-M5x16	
AIKT-KG-R/L-25-4-T8	●	●	25	34	200	40	8	23	20.5	KG.. - 4		

KRLY Ucuna Uygundur. / Compatible with KRLY Insert. / Под пластину KRYL

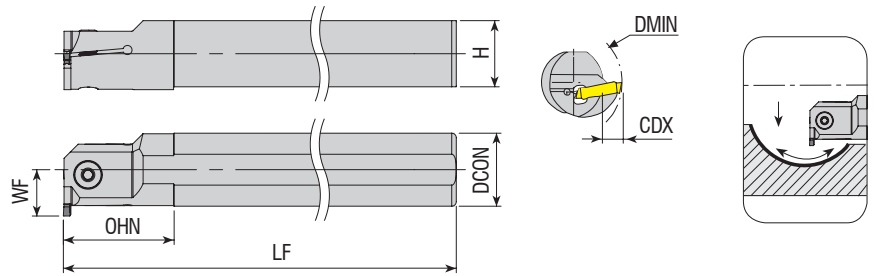

Takım Kodu Ordering Code Код для заказа	Stok Stock Наличие		Takım Ölçüleri (mm) Dimension (mm) Размеры (мм)							Kesici Uç Insert Пластина	Yedek Parçaları / Spare Parts / Запасные части	
	R	L	DCON	DMIN	LF	OHN	CDX	H	WF		Sıkma Vidası Screw Зажимной винт	Anahtar Allen Key Ключ
AIKT-H-R/L-25-3-T8	●	●	25	34	200	40	8	23	20.5	S229 - 3	2504-M5x16	AAL-05-4
AIKT-H-R/L-32-3-T7	●	●	32	40	250	50	7	30	23		2004-M8x1x20	
AIKT-H-R/L-40-3-T7	●	●	40	48	300	55	7	37.5	27	S229 - 4	2504-M5x16	
AIKT-H-R/L-25-4-T8	●	●	25	34	200	40	8	23	20.5		2004-M8x1x20	
AIKT-H-R/L-32-4-T7	●	●	32	40	250	50	7	30	23	S229 - 5	2504-M5x16	
AIKT-H-R/L-40-4-T7	●	●	40	48	300	55	7	37.5	27		2004-M8x1x20	
AIKT-H-R/L-25-5-T8	●	●	25	34	200	40	8	23	20.5	S229 - 5	2504-M5x16	
AIKT-H-R/L-32-5-T7	●	○	32	40	250	50	7	30	23		2004-M8x1x20	
AIKT-H-R/L-40-5-T7	●	○	40	48	300	55	7	37.5	27			

R: Sağ / Right / Правый L: Sol / Left / Левый
● Stokta / In Stock / В наличии ○ Stokta Yok / Non Stock Item / Нет в наличии
HRN Ucuna Uygundur. / Compatible with HRN Insert. / Под пластину HRN

Sipariş Örneği/Ordering Example/Образец заказа
1 ad./pcs./шт. AIKT-KG-R-25-2-T7

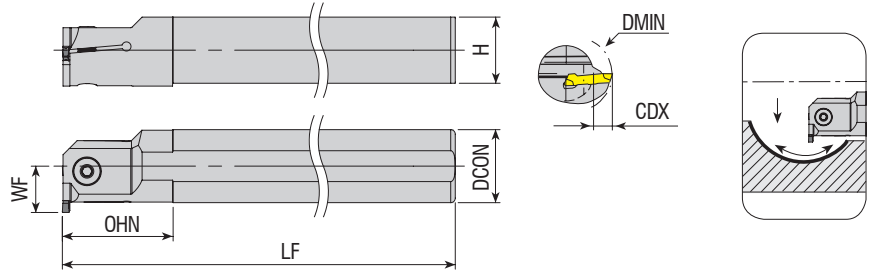

Takım Kodu Ordering Code Код для заказа	Stok Stock Наличие		Takım Ölçüleri (mm) Dimension (mm) Размеры (мм)							Kesici Uç Insert Пластина	Yedek Parçaları / Spare Parts / Запасные части	
	R	L	DCON	DMIN	LF	OHN	CDX	H	WF		Sıkma Vidası Screw Зажимной винт	Anahtar Allen Key Ключ
AIKT-HK-R/L-20-2-T6	●	●	20	26	170	30	6	18.3	16	S224 - 2	2503-M4x12	AAL-03-3
AIKT-HK-R/L-25-2-T6	●	○	25	32	200	40	6	23	18.5		2504-M5x16	
AIKT-HK-R/L-20-3-T6	●	○	20	27	170	30	6	18.3	16	S224 - 3	2504-M5x12	AAL-05-4
AIKT-HK-R/L-25-3-T6	●	●	25	32	200	40	6	23	18.5		2504-M5x16	
AIKT-HK-R/L-32-3-T6	●	●	32	39	250	50	6	30	22	2004-M8x1x20		
AIKT-HK-R/L-20-4-T6	●	○	20	27	170	30	6	18.3	16	2504-M5x12		
AIKT-HK-R/L-25-4-T6	●	○	25	32	200	40	6	23	18.5	S224 - 4	2504-M5x16	
AIKT-HK-R/L-32-4-T6	●	○	32	39	250	50	6	30	22		2004-M8x1x20	
AIKT-HS223-R/L-20-2-T5	●	○	20	26	170	33	5	18.3	15	S223 - 2	2503-M4x12	AAL-03-3
AIKT-HS223-R/L-25-2-T5	●	○	25	31	200	40	5	23	17.5		2504-M5x16	
AIKT-HS223-R/L-20-3-T6	●	○	20	27	170	33	6	18.3	16	S223 - 3	2504-M5x12	AAL-05-4
AIKT-HS223-R/L-25-3-T6	●	○	25	32	200	40	6	23	18.5		2504-M5x16	

HRN Ucuna Uygundur. / Compatible with HRN Insert. / Под пластину HRN

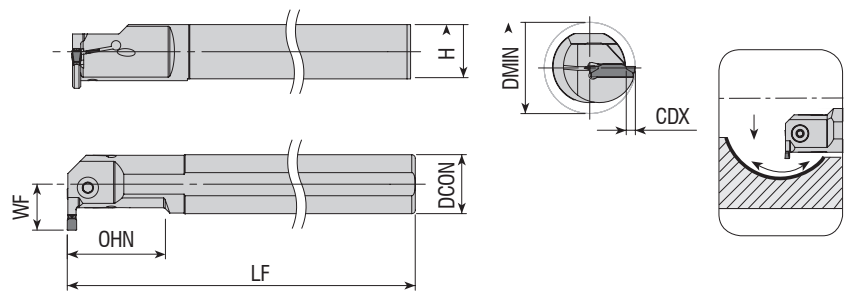

Takım Kodu Ordering Code Код для заказа	Stok Stock Наличие		Takım Ölçüleri (mm) Dimension (mm) Размеры (мм)							Kesici Uç Insert Пластина	Yedek Parçaları / Spare Parts / Запасные части	
	R	L	DCON	DMIN	LF	OHN	CDX	H	WF		Sıkma Vidası Screw Зажимной винт	Anahtar Allen Key Ключ
AIKT-KM-R/L-20-2-T7	●	●	20	25	170	40	7	18.3	13	A4. - 2	2503-M4x12	AAL-03-3
AIKT-KM-R/L-20-3-T7	●	○	20	25	170	40	7	18.3	13		2504-M5x12	AAL-05-4
AIKT-KM-R/L-25-3-T10	●	●	25	32	200	50	10	23	17	A4. - 3	2505-M6x16	AAL-07-5
AIKT-KM-R/L-32-3-T12	●	●	32	40	250	64	12	30	22		2505-M6x20	
AIKT-KM-R/L-40-3-T12	●	●	40	48	300	80	12	37.5	27	A4. - 4	2504-M5x12	AAL-05-4
AIKT-KM-R/L-20-4-T7	●	○	20	25	170	40	7	18.3	13		2504-M5x12	
AIKT-KM-R/L-32-4-T12.2-H	●	○	32	40	190	104	12.2	31	22	2504-M5x14		

R: Sağ / Right / Правый L: Sol / Left / Левый

● Stokta / In Stock / В наличии ○ Stokta Yok / Non Stock Item / Нет в наличии

KNMNTL Ucuna Uygundur. / Compatible with KNMNTL Insert. / Под пластину KNMNTL.

Sipariş Örneği/Ordering Example/Образец заказа

1 ad./pcs./шт. AIKT-HK-R-20-2-T6

DELİK İÇİ KANAL KATERLERİ
INTERNAL GROOVING TOOLHOLDERS
ДЕРЖАВКИ ДЛЯ ОБРАБОТКИ ВНУТРЕННИХ КАНАВOK

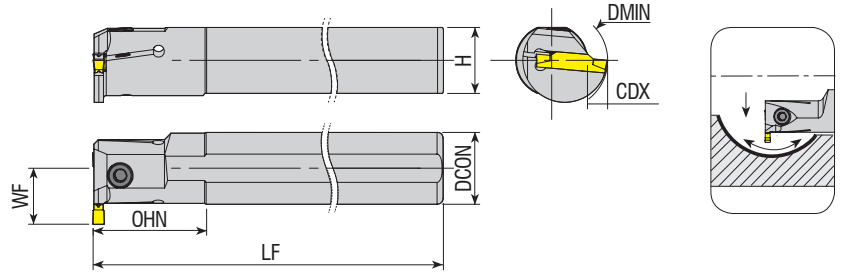

Takım Kodu Ordering Code Код для заказа	Stok Stock Наличие		Takım Ölçüleri (mm) Dimension (mm) Размеры (мм)							Kesici Uç Insert Пластина	Yedek Parçaları / Spare Parts / Запасные части	
	R	L	DCON	DMIN	LF	OHN	CDX	H	WF		Sıkma Vidası Screw Зажимной винт	Anahtar Allen Key Ключ
AIKT-123-R/L-20-2-T6	●	○	20	32	170	30	6	18.3	16	123 - 2	2503-M4x12	AAL-03-3
AIKT-123-R/L-25-2-T6	●	○	25	32	200	40	6	18.3	18.5		2504-M5x12	
AIKT-123-R/L-32-2-T7	●	○	32	41	250	45	7	30	23		2004-M8x1x20	
AIKT-123-R/L-20-3-T6	●	○	20	32	170	30	6	18.3	16	123 - 3	2504-M5x16	AAL-05-4
AIKT-123-R/L-25-3-T7	●	○	25	32	200	40	7	23	19.5		2004-M8x1x20	
AIKT-123-R/L-32-3-T9	●	○	32	41	250	50	9	30	25		2504-M5x16	
AIKT-123-R/L-20-4-T8	●	○	20	29	170	30	8	18.3	18	123 - 4	2004-M8x1x20	
AIKT-123-R/L-25-4-T7	●	○	25	32	200	40	7	23	19.5		2504-M5x16	
AIKT-123-R/L-32-4-T7	●	○	32	41	250	45	7	30	23		2004-M8x1x20	
AIKT-123-R/L-32-4-T10	●	○	32	43	250	50	10	30	26	123 - 5	2504-M5x16	
AIKT-123-R/L-25-5-T8	●	○	25	34	200	40	8	23	20.5		2004-M8x1x20	
AIKT-123-R/L-32-5-T11	●	○	32	43	250	50	11	30	27		2504-M5x16	

SNDVK Ucuna Uygundur. / Compatible with SNDVK Insert. / Под пластину SNDVK.

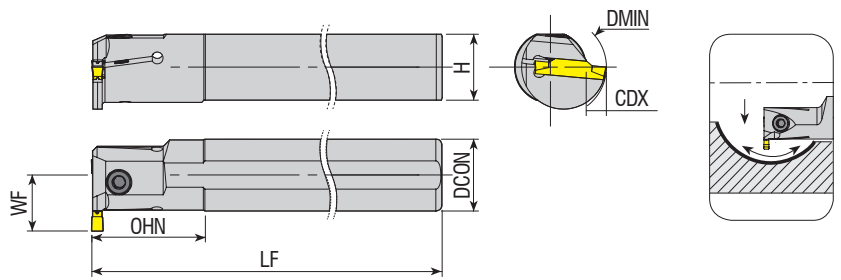

Takım Kodu Ordering Code Код для заказа	Stok Stock Наличие		Takım Ölçüleri (mm) Dimension (mm) Размеры (мм)							Kesici Uç Insert Пластина	Yedek Parçaları / Spare Parts / Запасные части	
	R	L	DCON	DMIN	LF	OHN	CDX	H	WF		Sıkma Vidası Screw Зажимной винт	Anahtar Allen Key Ключ
AIKT-151.23-R/L-20-2-T6	●	○	20	32	170	30	6	18.3	16	151.23 - 2	2503-M4x12	AAL-03-3
AIKT-151.23-R/L-20-2.5-T6	●	○	20	32	170	30	6	18.3	16			
AIKT-151.22-R/L-25-3-T6	○	●	25	37	200	32	6	23	18.5	151.23 - 3		
AIKT-151.22-R/L-25-3-T6-H	○	●	25	37	200	32	6	23	18.5			

R: Sağ / Right / Правый L: Sol / Left / Левый

● Stokta / In Stock / В наличии ○ Stokta Yok / Non Stock Item / Нет в наличии

SNDVK Ucuna Uygundur. / Compatible with SNDVK Insert. / Под пластину SNDVK.

Sipariş Örneği/Ordering Example/Образец заказа

1 ad./pcs./шт. AIKT-123-R-20-2-T6



www.akko.com.tr

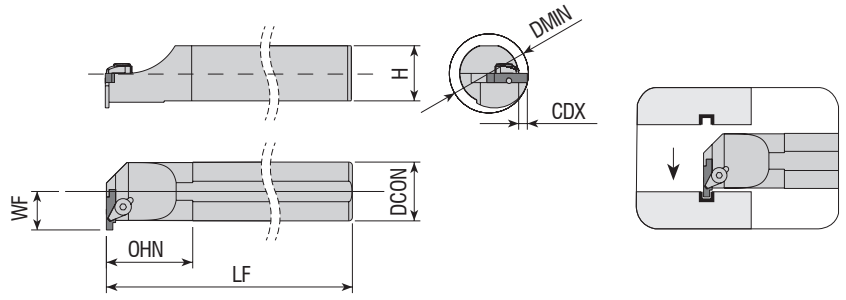

Takım Kodu Ordering Code Код для заказа	Stok Stock Наличие		Takım Ölçüleri (mm) Dimension (mm) Размеры (мм)							Kesici Uç Insert Пластина	Yedek Parçaları / Spare Parts / Запасные части			
	R	L	DCON	DMIN	LF	OHN	CDX	H	WF		Baskı Parçası Wedge Clamp Прижим	Sıkma Vidası Screw Зажимной винт	Pim Pin Штифт	Anahtar Allen Key Ключ
AIKT-154.91-R/L-16-3-T3	●	●	16	20	150	35	3	14.8	11	154.91 - 3	ACK-06	AKV-10-M6x14	APM-06	AAL-05-4
AIKT-154.91-R/L-20-3-T4	●	●	20	25	170	38	4	18.3	14					
AIKT-154.91-R/L-25-3-T4	●	●	25	31	200	40	4	23	16.5	154.91 - 5	ACK-03	AKV-21-M6x18	AAL-03-3	
AIKT-154.91-R/L-25-5-T5	●	●	25	31	200	45	5	23	17.5					
AIKT-154.91-R/L-32-5-T5	●	●	32	38	250	50	5	30	21					

SNDVK Ucuna Uygundur. / Compatible with SNDVK Insert. / Под пластину SNDVK.

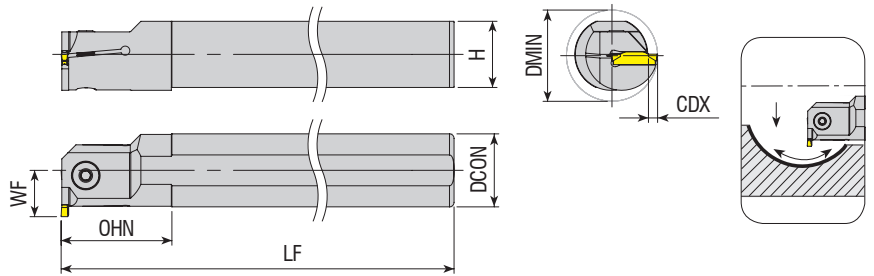

Takım Kodu Ordering Code Код для заказа	Stok Stock Наличие		Takım Ölçüleri (mm) Dimension (mm) Размеры (мм)							Kesici Uç Insert Пластина	Yedek Parçaları / Spare Parts / Запасные части	
	R	L	DCON	DMIN	LF	OHN	CDX	H	WF		Sıkma Vidası Screw Зажимной винт	Anahtar Allen Key Ключ
AIKT-RD-R/L-16-2-T6	●	○	16	24	150	28	6	14.8	14	RD. - 2	2503-M4x10	AAL-03-3
AIKT-RD-R/L-20-2-T6	●	○	20	28	170	28	6	18.3	16			
AIKT-RD-R/L-25-2-T6	●	○	25	33	200	28	6	23	18.5			
AIKT-RD-R/L-16-3-T6	●	○	16	24	150	28	6	14.8	14	RD. - 3	2503-M4x10	AAL-03-3
AIKT-RD-R/L-20-3-T6	●	○	20	28	170	28	6	18.3	16			
AIKT-RD-R/L-25-3-T6	●	○	25	33	200	28	6	23	18.5			
AIKT-RD-R/L-32-3-T6	●	○	32	40	250	50	6	30	22			
AIKT-RD-R/L-20-4-T6	●	○	20	28	170	28	6	18.3	16	RD. - 4	2504-M5x12	AAL-05-4
AIKT-RD-R/L-25-4-T6	●	○	25	33	200	28	6	23	18.5			
AIKT-RD-R/L-32-4-T6	●	○	32	40	250	50	6	30	22			

R: Sağ / Right / Правый L: Sol / Left / Левый
● Stokta / In Stock / В наличии ○ Stokta Yok / Non Stock Item / Нет в наличии
TGTC Ucuna Uygundur. / Compatible with TGTC Insert. / Под пластину TGTC.

Sipariş Örneği/Ordering Example/Образец заказа
1 ad./pcs./шт. AIKT-154.91-R-16-3-T3

DELİK İÇİ KANAL KATERLERİ
INTERNAL GROOVING TOOLHOLDERS
ДЕРЖАВКИ ДЛЯ ОБРАБОТКИ ВНУТРЕННИХ КАНАВОК

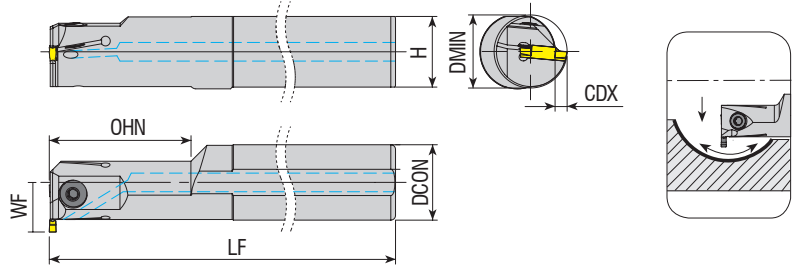

Takım Kodu Ordering Code Код для заказа	Stok Stock Наличие		Takım Ölçüleri (mm) Dimension (mm) Размеры (мм)							Kesici Uç Insert Пластина	Yedek Parçaları / Spare Parts / Запасные части	
	R	L	DCON	DMIN	LF	OHN	CDX	H	WF		Sıkma Vidası Screw Зажимной винт	Anahtar Allen Key Ключ
AIKT-TD-R/L-16-2-T8.5-H	●	○	16	25	150	28	8.5	14.8	16.5	TD. - 2	2503-M4x10	AAL-03-3
AIKT-TD-R/L-20-3-T6-H	●	○	20	25	170	40	6	18.3	16			
AIKT-TD-R/L-25-3-T6-H	●	○	25	25	200	40	6	23	18.5	TD. - 3	2504-M5x12 2504-M5x16	AAL-05-4
AIKT-TD-R/L-32-3-T5-H	●	○	32	31	250	60	5	30	21			
new AIKT-TD-R/L-20-4-T10-H	○	●	20	27	170	40	10	18.3	20	TD. - 4	2504-M5x12 2504-M5x16	AAL-05-4
new AIKT-TD-R/L-25-4-T10-H	○	●	25	31	200	40	10	23	22.5			
new AIKT-TD-R/L-32-4-T10-H	○	●	32	36	250	60	10	30	26		2004-M8x1x20	

TGTC Ucuna Uygun. / Compatible with TGTC Insert. / Под пластину TGTC.

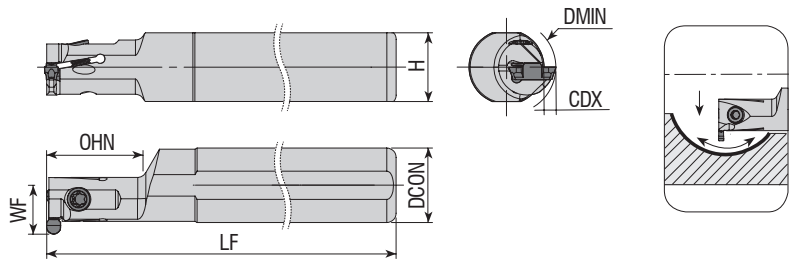

Takım Kodu Ordering Code Код для заказа	Stok Stock Наличие		Takım Ölçüleri (mm) Dimension (mm) Размеры (мм)							Kesici Uç Insert Пластина	Yedek Parçaları / Spare Parts / Запасные части	
	R	L	DCON	DMIN	LF	OHN	CDX	H	WF		Sıkma Vidası Screw Зажимной винт	Tork Anahtar Torx Key Торх Ключ
AIKT-IGE-R/L-10-2-T3-H	●	○	10	11.5	125	25	3	9	8.3	GEPI - 2	3008-M3x8	82-T08
AIKT-IGE-R/L-16-2-T3-D11.5	●	○	16	11.5	125	20	3	14.8	11.1			
new AIKT-IGE-R/L-16-2-T3-D11.5-H	●	○	16	11	125	22	3	14.8	11	GEPI - 3	1315-M4x11	80-T15
AIKT-IGE-R/L-16-2-T2.5-H	●	●	16	13	125	20	2.5	14.8	10.5			
AIKT-IGE-R/L-16-3-T2.5-H	●	○	16	13	125	20	2.5	14.8	10.5			
AIKT-IGE-R/L-16-3-T2.5-D20	●	○	16	20	125	28	2.5	14.8	10.5			

R: Sağ / Right / Правый L: Sol / Left / Левый
● Stokta / In Stock / В наличии ○ Stokta Yok / Non Stock Item / Нет в наличии
ISCR Ucuna Uygun. / Compatible with ISCR Insert. / Под пластину ISCR.

Sipariş Örneği/Ordering Example/Образец заказа
1 ad./pcs./шт. AIKT-TD-R-16-2-T8.5-H

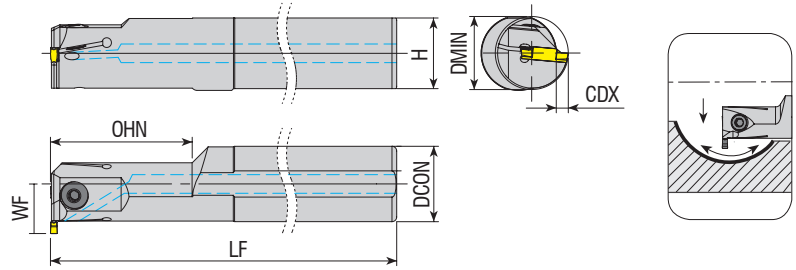

Takım Kodu Ordering Code Код для заказа	Stok Stock Наличие		Takım Ölçüleri (mm) Dimension (mm) Размеры (мм)							Kesici Uç Insert Пластина	Yedek Parçaları / Spare Parts / Запасные части		
	R	L	DCON	DMIN	LF	OHN	CDX	H	WF		Sıkma Vidası Screw Зажимной винт	Tork Anahtar Torx Key Торх Ключ	Anahtar Allen Key Ключ
AIKT-IGI-R/L-20-3-T4	●	●	20	20	170	25	4	18.3	14.5	GIMIY / GIPI - 3	1020-M5x14	80-T20	
AIKT-IGI-R/L-25-3-T5	●	●	25	23	200	30	5	23	17		2504-M5x16		
AIKT-IGI-R/L-32-3-T5	●	●	32	31	250	30	5	30	21		2004-M8x1x20	AAL-05-4	
AIKT-IGI-R/L-40-3-T5	●	○	40	50	300	50	5	37.5	25	GIMIY / GIPI - 4	1020-M5x14	80-T20	
AIKT-IGI-R/L-20-4-T4	●	●	20	20	170	25	4	18.3	14.5				
AIKT-IGI-R/L-25-5-T10	●	○	25	32	200	25	10	23	22.5	GIMIY / GIPI - 5	2504-M5x16	AAL-05-4	
AIKT-IGI-R/L-25-5-T10-H	●	○	25	32	200	25	10	23	22.5				
AIKT-IGI-R/L-25-5-T15	●	○	25	37	200	25	15	23	27.5				
AIKT-IGI-R/L-25-5-T15-H	●	○	25	37	200	25	15	23	27.5				

ISCR Ucuna Uygun. / Compatible with ISCR Insert. / Под пластину ISCR.

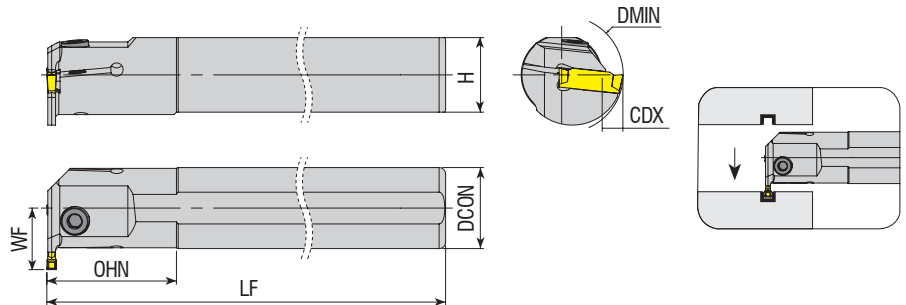

Takım Kodu Ordering Code Код для заказа	Stok Stock Наличие		Takım Ölçüleri (mm) Dimension (mm) Размеры (мм)							Kesici Uç Insert Пластина	Yedek Parçaları / Spare Parts / Запасные части	
	R	L	DCON	DMIN	LF	OHN	CDX	H	WF		Sıkma Vidası Screw Зажимной винт	Anahtar Allen Key Ключ
AIKT-I-R/L-20-3-T5	●	●	20	26	170	25	5	18.3	15.5	DGN - 3	2504-M5x12	AAL-05-4
AIKT-I-R/L-25-3-T6	●	●	25	32	200	40	6	23	19		2504-M5x16	

R: Sağ / Right / Правый L: Sol / Left / Левый

● Stokta / In Stock / В наличии ○ Stokta Yok / Non Stock Item / Нет в наличии

ISCR Ucuna Uygun. / Compatible with ISCR Insert. / Под пластину ISCR.

Sipariş Örneği/Ordering Example/Образец заказа

1 ad./pcs./шт. AIKT-IGI-R-20-3-T4

DELİK İÇİ KANAL KATERLERİ
INTERNAL GROOVING TOOLHOLDERS
ДЕРЖАВКИ ДЛЯ ОБРАБОТКИ ВНУТРЕННИХ КАНАВOK

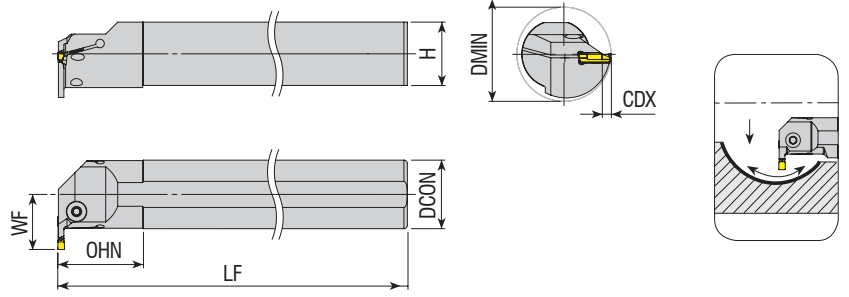

Takım Kodu Ordering Code Код для заказа	Stok Stock Наличие		Takım Ölçüleri (mm) Dimension (mm) Размеры (мм)							Kesici Uç Insert Пластина	Yedek Parçaları / Spare Parts / Запасные части		
	R	L	DCON	DMIN	LF	OHN	CDX	H	WF		Sıkma Vidası Screw Зажимной винт	Anahtar Allen Key Ключ	
AIKT-IG-R/L-25-4-T10-H	●	●	25	36	200	40	10	23	22.7	DGN / GRP - 4	2504-M5X16	AAL-05-4	
AIKT-IG-R/L-32-4-T10-H	●	●	32	43	250	45	10	30	26.2		2004-M8x1x20		
AIKT-IG-R/L-40-4-T12-H	●	●	40	53	250	50	12	37.5	32.2		2504-M5X16		
AIKT-IG-R/L-25-5-T10-H	●	○	25	43	200	40	10	23	22.7	DGN / GRP - 5	2504-M5X16	AAL-05-4	
AIKT-IG-R/L-32-5-T10-H	●	○	32	43	250	45	10	30	26.2		2004-M8x1x20		
AIKT-IG-R/L-40-5-T12-H	●	○	40	53	250	50	12	37.5	32.2		2504-M5X16		
AIKT-IG-R/L-50-5-T12-H	●	○	50	63	300	60	12	47	37.2		2004-M8x1x20		

ISCR Ucuна Uyğundur. / Compatible with ISCR Insert. / Под пластину ISCR.

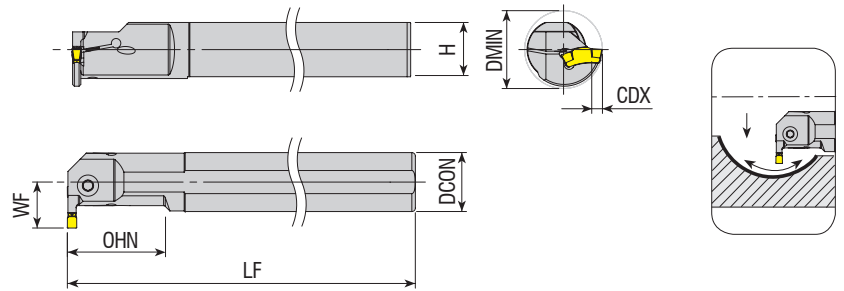

Takım Kodu Ordering Code Код для заказа	Stok Stock Наличие		Takım Ölçüleri (mm) Dimension (mm) Размеры (мм)							Kesici Uç Insert Пластина	Yedek Parçaları / Spare Parts / Запасные части				
	R	L	DCON	DMIN	LF	OHN	CDX	H	WF		Sıkma Vidası Screw Зажимной винт	Tork Anahtar Torx Key Торх Ключ	Anahtar Allen Key Ключ		
AIKT-ITG-R/L-16-3-T6-H	●	●	16	20	150	25	6	14.8	12	TGM. - 3	1020-M4.5X14	80-T20			
AIKT-ITG-R/L-20-3-T6-H	●	●	20	25	170	32	6	18.3	14.2		1020-M4.5X16				
AIKT-ITG-R/L-25-3-T8-H	●	●	25	32	200	40	8	23	18.8		2504-M5X16			AAL-05-4	
AIKT-ITG-R/L-32-3-T8-H	●	●	32	38	250	49	8	30	22		2004-M8x1x20				
AIKT-ITG-R/L-20-4-T6-H	●	●	20	25	170	33	6	18.3	14.2	TGM. - 4	1020-M4.5X16	80-T20			
AIKT-ITG-R/L-25-4-T7-H	●	●	25	31	200	41	7	23	17.5		2504-M5X16				
AIKT-ITG-R/L-25-4-T9-H	●	●	25	32.5	200	41	9	23	19.5		2504-M5X16			AAL-05-4	
AIKT-ITG-R/L-32-4-T11-H	●	●	32	42	250	50	11	30	25.5		2004-M8x1x20				
AIKT-ITG-R/L-40-4-T11-H	●	●	40	53	300	50	11	37.5	32	TGM. - 6.35	2004-M8x1x20	AAL-05-4			
AIKT-ITG-R/L-32-6.35-T17.5-H	●	●	32	57	250	50	17.5	30	29		2004-M8x1x20				

R: Sağ / Right / Правый L: Sol / Left / Левый

● Stokta / In Stock / В наличии ○ Stokta Yok / Non Stock Item / Нет в наличии

ISCR Ucuна Uyğundur. / Compatible with ISCR Insert. / Под пластину ISCR.

Sipariş Örneği/Ordering Example/Образец заказа

1 ad./pcs./шт. AIKT-IG-R-25-4-T10-H

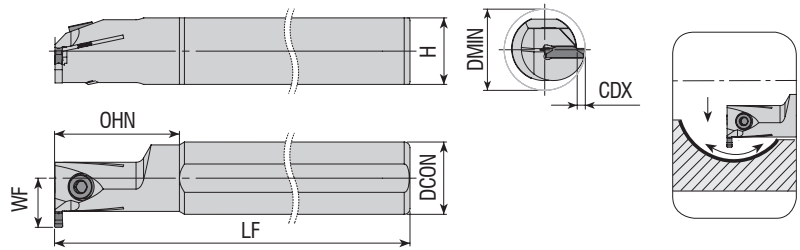

Takım Kodu Ordering Code Код для заказа	Stok Stock Наличие		Takım Ölçüleri (mm) Dimension (mm) Размеры (мм)							Kesici Uç Insert Пластина	Yedek Parçaları / Spare Parts / Запасные части	
	R	L	DCON	DMIN	LF	OHN	CDX	H	WF		Sikma Vidası Screw Зажимной винт	Anahtar Allen Key Ключ
AIKT-GP-R/L-20-2-T4	●	○	20	25	170	30	4	18.3	14.5	GP - 2	2503-M4x12	AAL-03-3
AIKT-GP-R/L-25-2-T6	●	○	25	32	200	40	6	23	18.5			
AIKT-GP-R/L-20-3-T6	●	○	20	27	170	30	6	18.3	16	GP - 3	2504-M5x16	AAL-05-4
AIKT-GP-R/L-25-3-T6	●	○	25	32	200	40	6	23	18.5			
AIKT-GP-R/L-32-3-T6	●	○	32	39	250	50	6	30	22			
AIKT-GP-R/L-20-4-T6	●	○	20	27	170	30	6	18.3	16	GP - 4	2504-M5x16	
AIKT-GP-R/L-25-4-T6	●	○	25	32	200	40	6	23	18.5			
AIKT-GP-R/L-32-4-T6	●	○	32	39	250	50	6	30	22		2004-M8x1x20	

PLBT Ucuna Uygunur. / Compatible with PLBT Insert. / Под пластину PLBT.

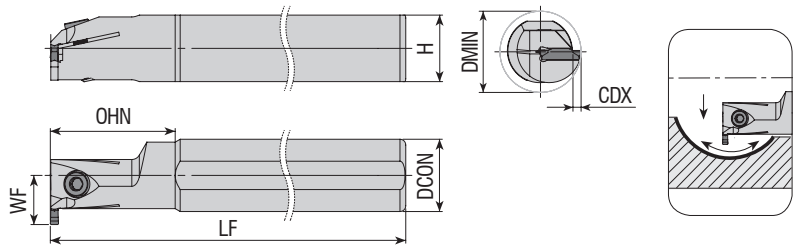

Takım Kodu Ordering Code Код для заказа	Stok Stock Наличие		Takım Ölçüleri (mm) Dimension (mm) Размеры (мм)							Kesici Uç Insert Пластина	Yedek Parçaları / Spare Parts / Запасные части	
	R	L	DCON	DMIN	LF	OHN	CDX	H	WF		Sikma Vidası Screw Зажимной винт	Tork Anahtar Torx Key Торх Ключ
AIKT-TG-R/L-20-2-T6	●	○	20	28	160	28	6	18.3	15.8	DGM2-020	2503-M4x10	AAL-03-3
AIKT-TG-R/L-20-3-T6	●	○	20	28	160	28	6	18.3	15.8			
AIKT-TG-R/L-25-3-T8	●	○	25	35	200	28	8	23	21.5	DTX3-030	2504-M5x16	AAL-05-4
AIKT-TG-R/L-32-3-T10	●	○	32	43	250	50	10	30	27			
AIKT-TG-R/L-32-3-T12	●	○	32	45	250	50	12	30	27			
AIKT-TG-R/L-32-4-T10	●	○	32	43	250	50	10	30	27	DTX4-040	2004-M8x1x20	
AIKT-TG-R/L-32-5-T10	●	○	32	43	250	50	10	30	27			DTX5-040

R: Sağ / Right / Правый L: Sol / Left / Левый

● Stokta / In Stock / В наличии ○ Stokta Yok / Non Stock Item / Нет в наличии

TNGLY Ucuna Uygunur. / Compatible with TNGLY Insert. / Под пластину TNGLY.

Sipariş Örneği/Ordering Example/Образец заказа

1 ad./pcs./шт. AIKT-GP-R-20-2-T4

DELİK İÇİ KANAL KATERLERİ
INTERNAL GROOVING TOOLHOLDERS
ДЕРЖАВКИ ДЛЯ ОБРАБОТКИ ВНУТРЕННИХ КАНАВОК

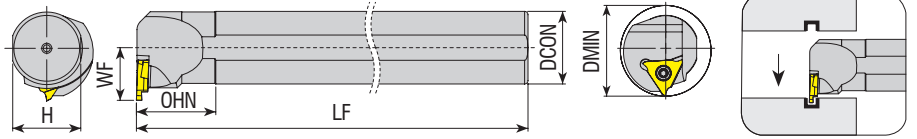

Takım Kodu Ordering Code Код для заказа	Stok Stock Наличие		Takım Ölçüleri (mm) Dimension (mm) Размеры (мм)							Kesici Uç Insert Пластина	Yedek Parçaları / Spare Parts / Запасные части	
	R	L	DCON	DMIN	LF	OHN	CDX	H	WF		Sıkma Vidası Screw Зажимной винт	Anahtar Allen Key Ключ
AIKT-QC11-R/L-20-(0.5-1.8)	●	○	20	16	150	40	-	18.3	11.1	QC11R/L (0.50-1.80)	3008 M2.5x6	82-T08
AIKT-QC16-R/L-20-(0.5-1.8)	○	○	20	25	150	35	-	18.3	13.5			
AIKT-QC16-R/L-20-(0.5-2.5)	●	○	20	25	150	35	-	18.3	13.5	QC16R/L (0.50-2.50)	1020 M5x11	80-T20
AIKT-QC22-R/L-25-(1-2.3)	○	○	25	35	150	35	-	23	18.2	QC22R/L (1.00-2.30)		
AIKT-QC22-R/L-25-(2.5-3.3)	●	○	25	35	150	35	-	23	18.2	QC22R/L (2.50-3.30)		
AIKT-QC22-R/L-25-(3.3-4.8)	●	○	25	35	150	35	-	23	18.2	QC22R/L (3.30-4.80)		
AIKT-QC22-R/L-32-(1-2.3)	○	○	32	45	150	35	-	30	23.2	QC22R/L (1.00-2.30)		

ZCC Ucuna Uygundur. / Compatible with ZCC Insert. / Под пластину ZCC.

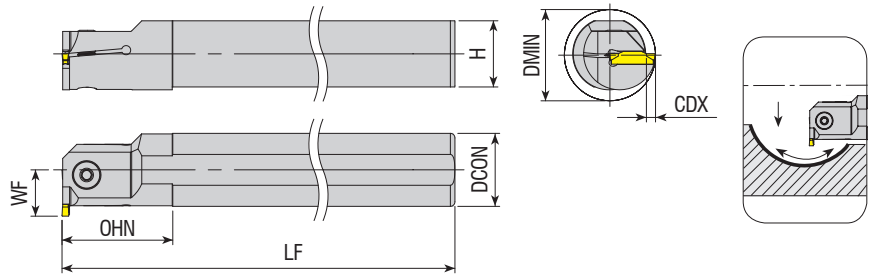

Takım Kodu Ordering Code Код для заказа	Stok Stock Наличие		Takım Ölçüleri (mm) Dimension (mm) Размеры (мм)							Kesici Uç Insert Пластина	Yedek Parçaları / Spare Parts / Запасные части	
	R	L	DCON	DMIN	LF	OHN	CDX	H	WF		Sıkma Vidası Screw Зажимной винт	Anahtar Allen Key Ключ
AIKT-ZCC2-R/L-16-2-T4	●	○	16	21	150	28	4	14.8	12	Z.BD - 2	2503-M4x10	AAL-03-3
AIKT-ZCC2-R/L-20-3-T5	●	●	20	27	170	30	5	18.3	15			
AIKT-ZCC2-R/L-20-3-T8	●	○	20	29	170	30	8	18.3	18	Z.FD - 3	2504-M5x16	
AIKT-ZCC2-R/L-25-3-T5	●	○	25	31	200	40	5	23	17.5			Z.FD - 3
AIKT-ZCC2-R/L-25-3-T10	●	○	25	36	200	40	10	23	22.5	Z.GD - 4	2504-M5x16	
AIKT-ZCC2-R/L-32-3-T6	●	○	32	39	250	50	6	30	22			Z.GD - 4
AIKT-ZCC2-R/L-32-3-T8	●	○	32	41	250	50	8	30	24	Z.GD - 4	2004-M8x1x20	
AIKT-ZCC2-R/L-32-3-T13	●	○	32	46	250	50	13	30	29			Z.HD - 5
AIKT-ZCC2-R/L-40-3-T12	●	○	40	53	300	55	12	37.5	32	Z.HD - 5	2004-M8x1x20	
AIKT-ZCC2-R/L-25-4-T6	●	○	25	32	200	40	6	23	18.5			Z.HD - 5
AIKT-ZCC2-R/L-32-4-T7	●	○	32	40	250	50	7	30	23	Z.HD - 5	2004-M8x1x20	
AIKT-ZCC2-R/L-32-4-T8	●	○	32	41	250	50	8	30	24			Z.HD - 5
AIKT-ZCC2-R/L-32-4-T10	●	○	32	43	250	50	10	30	26	Z.HD - 5	2004-M8x1x20	
AIKT-ZCC2-R/L-32-5-T7	●	○	32	40	250	50	7	30	23			Z.HD - 5
AIKT-ZCC2-R/L-32-5-T8	●	○	32	41	250	50	8	30	24	Z.HD - 5	2004-M8x1x20	
AIKT-ZCC2-R/L-40-5-T8	●	○	40	49	300	55	8	37.5	28			Z.HD - 5
AIKT-ZCC2-R/L-40-5-T10	●	○	40	51	300	55	10	37.5	30	Z.HD - 5	2004-M8x1x20	

R: Sağ / Right / Правый L: Sol / Left / Левый

● Stokta / In Stock / В наличии ○ Stokta Yok / Non Stock Item / Нет в наличии

ZCC Ucuna Uygundur. / Compatible with ZCC Insert. / Под пластину ZCC.

Sipariş Örneği/Ordering Example/Образец заказа

1 ad./pcs./шт. AIKT-QC11-R-20-(0.5-1.8)



www.akkо.com.tr

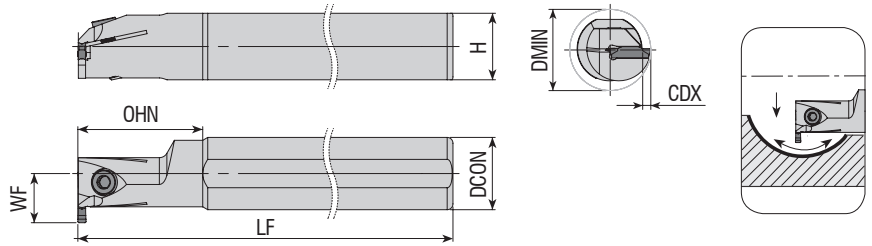

Takım Kodu Ordering Code Код для заказа	Stok Stock Наличие		Takım Ölçüleri (mm) Dimension (mm) Размеры (мм)							Kesici Uç Insert Пластина	Yedek Parçaları / Spare Parts / Запасные части	
	R	L	DCON	DMIN	LF	OHN	CDX	H	WF		Sıkma Vidası Screw Зажимной винт	Anahtar Allen Key Ключ
AIKT-SGC-R/L-25-3-T6	●	○	25	32	200	40	6	23	18.5	GCM N30	2504-M5x16	AAL-05-4
AIKT-SGC-R/L-32-3-T6	●	○	32	39	250	50	6	30	22		2004-M8x1x20	
AIKT-SGC-R/L-40-3-T6	●	○	40	47	300	55	6	37.5	26			

SMTM Ucuna Uygunur. / Compatible with SMTM Insert. / Под пластину SMTM

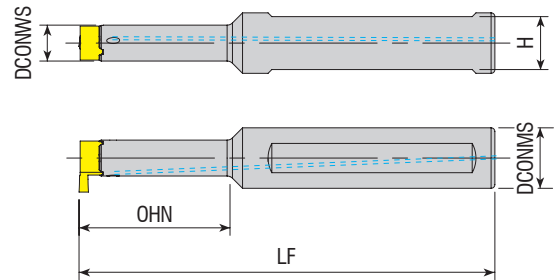
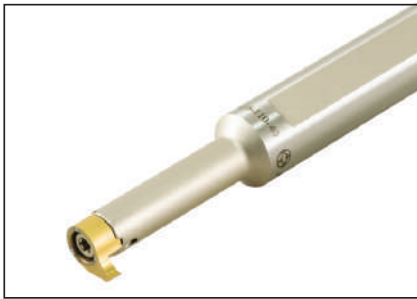

Takım Kodu Ordering Code Код для заказа	Stok Stock Наличие	Takım Ölçüleri (mm) Dimension (mm) Размеры (мм)					Kesici Uç Insert Пластина	Yedek Parçaları / Spare Parts / Запасные части	
		DCONMS	DCONWS	LF	OHN	H		Sıkma Vidası Screw Зажимной винт	Anahtar Allen Key Ключ
AIKT-MB07-A16-090-15	●	16	7.4	90	15	14	MB - 07	4008-M3x8	82-T08
AIKT-MB07-A16-090-22	●	16	7.4	90	22	14			
AIKT-MB09-A16-090-19	●	16	9.5	90	19	14	MB - 09	4015-M4x11	80-T15
AIKT-MB09-A16-095-28	●	16	9.5	95	28	14			
AIKT-MB09-A16-110-40	●	16	9.5	110	40	14			

R: Sağ / Right / Правый L: Sol / Left / Левый

● Stokta / In Stock / В наличии ○ Stokta Yok / Non Stock Item / Нет в наличии

SNDVK Ucuna Uygunur. / Compatible with SNDVK Insert. / Под пластину SNDVK.

Sipariş Örneği/Ordering Example/Образец заказа
1 ad./pcs./шт. AIKT-SGC-R-25-3-T6

konusulan
the spoken kalite...
quality...





DELİK DELME ve İŞLEME TAKIMLARI
DRILLING and HOLEMAKING TOOLS
ИНСТРУМЕНТ ДЛЯ СВЕРЛЕНИЯ И ОБРАБОТКИ ОТВЕРСТИЙ





*konusulan
the spoken kalite...
quality...*

U-DRILL

TAKMA UÇLU MATKAPLAR
U-DRILL SYSTEM
СВЕРЛА

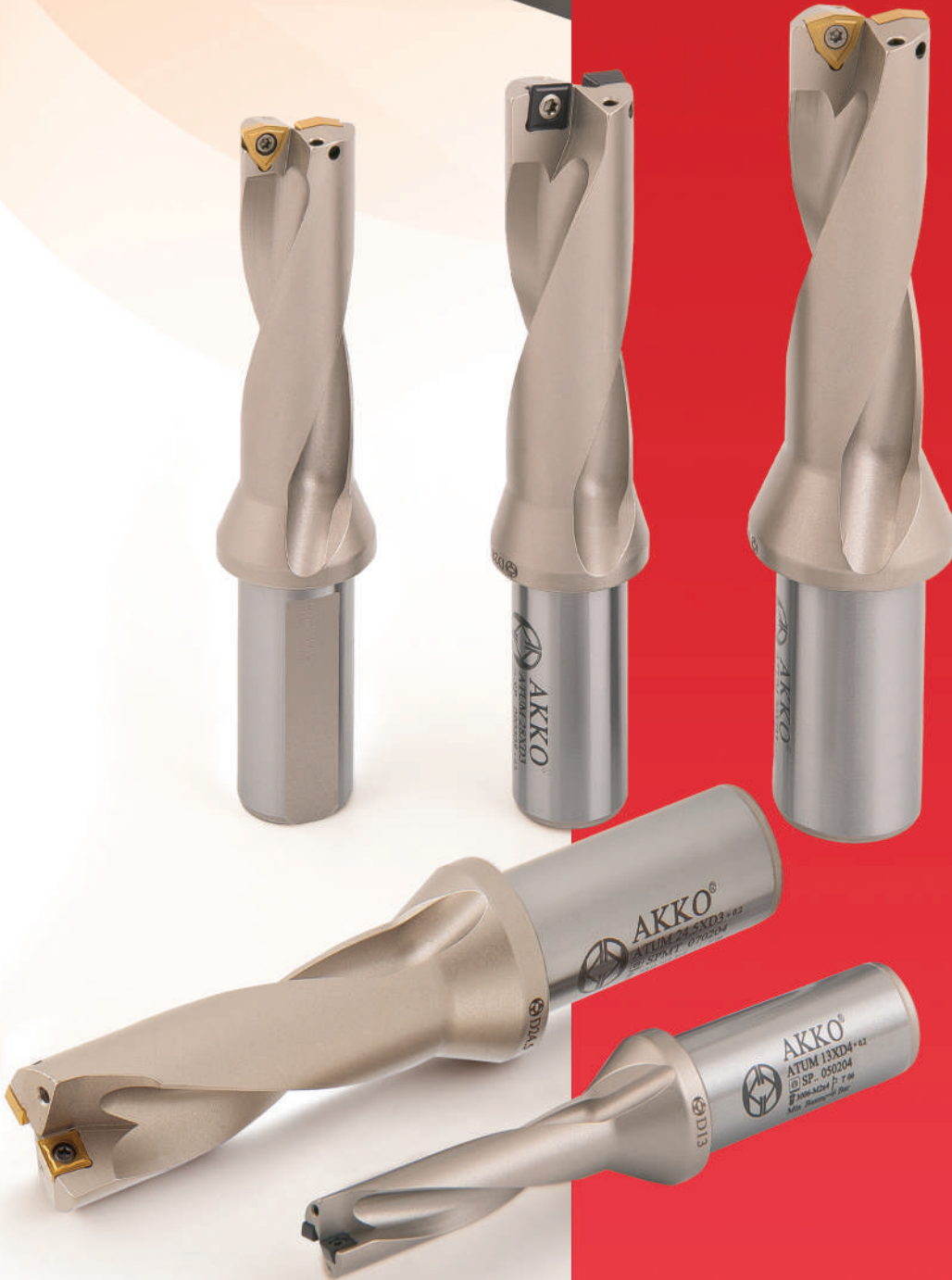



AKKO **A** **TUM** **16** x **D3**

S **P** **G** **T** **06** **02** **04**

2 Kesici Stili / Cutter Style
Тип режущего инструмента

TUM: Takma Uçlu Matkap
U-Drill
сверла

3 Takım Çapı / Tool Diameter /
Диаметр Сверла

4 Delme Derinliği / Drilling Depth /
Глубина сверления

5 Uç Şekli / Insert Form
Форма пластины

W **S**

8 Uç Tipi / Insert Type
Форма пластины

A J T
 $\beta = 70-90^\circ$ $\beta = 70-90^\circ$ $\beta = 40-60^\circ$

B M
 $\beta = 70-90^\circ$

C N
 $\beta = 70-90^\circ$

F Q
 $\beta = 40-60^\circ$

G R
 $\beta = 70-90^\circ$

H X **Özel**
Special
специальная

U W
 $\beta = 40-60^\circ$

10 Kalınlık / Thickness
Толщина

01 s = 1.59
T1 s = 1.98
02 s = 2.38
T2 s = 2.78
03 s = 3.18
T3 s = 3.97
04 s = 4.76
05 s = 5.56
06 s = 6.35
07 s = 7.94
09 s = 9.52

6 Serbest Uç Açısı / Clearance angle of Insert
Задний угол пластины

C **P**

7 Toleranslar / Tolerance Classes / Допуск

	IC	M	S
A	± 0.025	± 0.005	± 0.025
C	± 0.025	± 0.013	± 0.025
E	± 0.025	± 0.025	± 0.025
F	± 0.013	± 0.005	± 0.025
G	± 0.025	± 0.025	± 0.130
H	± 0.013	± 0.013	± 0.025
J	± 0.05-0.15	± 0.005	± 0.025
K	± 0.05-0.15	± 0.013	± 0.025
L	± 0.05-0.15	± 0.025	± 0.025
M	± 0.05-0.15	± 0.08-0.20	± 0.130
N	± 0.05-0.15	± 0.08-0.20	± 0.025
U	± 0.08-0.25	± 0.13-0.38	± 0.130

IC : Daire Ölçüsü / Inscribed Circle / Вписанная окружность
M : Şekle Göre / Refer to Figure / Рисунок
S : Kalınlık / Thickness / Толщина

9 Kesme Kenar Uzunluğu / Cutting Edge Length
Длина режущей кромки

11 Köşe Konfigürasyonu / Corner Radius
Радиус при вершине

01 r = 0.1
02 r = 0.2
04 r = 0.4
08 r = 0.8
12 r = 1.2
16 r = 1.6
24 r = 2.4



Delme Derinliği = 2x Çap
Drilling Depth = 2x Diameter
Глубина сверления = 2x Диаметр

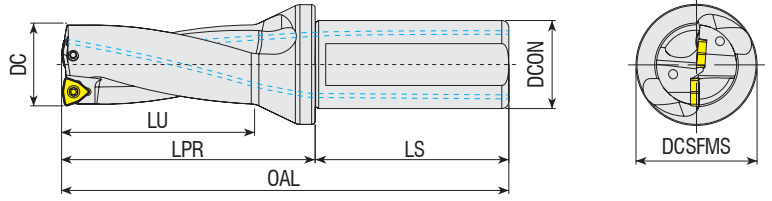

Takım Kodu Ordering Code Код для заказа	Stok Stock Наличие	Takım Ölçüleri (mm) Dimension (mm) Размеры (мм)							Maks. Ofset (radyal) Max. Offset (radial) Радиальное смещение		Kesici Uç Insert Пластина	Yedek Parçaları / Spare Parts / Запасные части		
		DC	DCON	DCSFMS	OAL	LU	LPR	LS	X _{max}	DC _{max}		Sikma Vidası Screw Зажимной винт	Tork Anahtar Torx Key Торх Ключ	
ATUM 16XD2 WCM. 030208	●	16	25	34	110	32	54	56	1.5	19	WCM. 030208	3008-M2.5x6	82-T08	
ATUM 16.5XD2 WCM. 030208	●	16.5	25	34	110	32	54	56	1.5	19.5				
ATUM 17XD2 WCM. 030208	●	17	25	34	112	34	56	56	1.5	20				
ATUM 17.5XD2 WCM. 030208	●	17.5	25	34	112	34	56	56	1.5	20.5				
ATUM 18XD2 WCM. 030208	●	18	25	34	114	36	58	56	1.4	20.8				
ATUM 18.5XD2 WCM. 030208	●	18.5	25	34	114	36	58	56	1.3	21.1				
ATUM 19XD2 WCM. 030208	●	19	25	34	116	38	60	56	1.2	21.4				
ATUM 19.5XD2 WCM. 030208	●	19.5	25	34	116	38	60	56	1.2	21.9				
ATUM 20XD2 WCM. 040208	●	20	25	34	118	40	62	56	1.5	23				WCM. 040208
ATUM 20.5XD2 WCM. 040208	●	20.5	25	34	118	40	62	56	1.5	23.5				
ATUM 21XD2 WCM. 040208	●	21	25	34	120	42	64	56	1	23				
ATUM 21.5XD2 WCM. 040208	●	21.5	25	34	120	42	64	56	1	23.5				
ATUM 22XD2 WCM. 040208	●	22	25	34	122	44	66	56	1	24				
ATUM 22.5XD2 WCM. 040208	●	22.5	25	34	122	44	66	56	1	24.5				
ATUM 23XD2 WCM. 040208	●	23	25	34	124	46	68	56	1	25				
ATUM 23.5XD2 WCM. 040208	●	23.5	25	34	124	46	68	56	1	25.5				
ATUM 24XD2 WCM. 050308	●	24	25	34	126	48	70	56	1.4	26.8	WCM. 050308	3008-M3x8	82-T08	
ATUM 24.5XD2 WCM. 050308	●	24.5	25	34	126	48	70	56	1.4	27.3				
ATUM 25XD2 WCM. 050308	●	25	25	34	128	50	72	56	1.45	27.9				
ATUM 25.5XD2 WCM. 050308	●	25.5	25	34	128	50	72	56	1.45	28.4				
ATUM 26XD2 WCM. 050308	●	26	25	34	130	52	74	56	1.45	28.9				
ATUM 26.5XD2 WCM. 050308	●	26.5	25	34	130	52	74	56	1.45	29.4				
ATUM 27XD2 WCM. 050308	●	27	25	34	132	54	76	56	1.45	29.9				
ATUM 27.5XD2 WCM. 050308	●	27.5	25	34	132	54	76	56	1.45	30.4				
ATUM 28XD2 WCM. 050308	●	28	25	34	134	56	78	56	1.6	31.2				
ATUM 28.5XD2 WCM. 050308	●	28.5	25	34	134	56	78	56	1.6	31.7				
ATUM 29XD2 WCM. 050308	●	29	25	34	136	58	80	56	1.65	32.3				
ATUM 29.5XD2 WCM. 050308	●	29.5	25	34	136	58	80	56	1.65	32.8				

R: Sağ / Right / Правый L: Sol / Left / Левый

● Stokta / In Stock / В наличии ○ Stokta Yok / Non Stock Item / Нет в наличии

ISO Ucuna Uygunudur. / Compatible with ISO Insert. / Под пластину ISO.

Sipariş Örneği/Ordering Example/Образец заказа

1 ad./pcs./шт. ATUM 16XD2 WCM. 030208

Takma Uçlu Matkap Kullanım Kılavuzu : S 375 / User's Guide For U-Drills : P 375

Руководство для эксплуатации сверел: стр. 375



Delme Derinliği = 2x Çap
Drilling Depth = 2x Diameter
Глубина сверления = 2x Диаметр

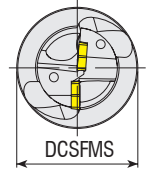
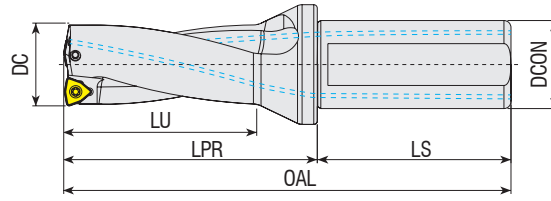

Takım Kodu
Ordering Code
Код для заказа

Stok
Stock
Наличие

Takım Ölçüleri (mm)
Dimension (mm)
Размеры (мм)

Maks. Ofset (radial)
Max. Offset (radial)
Радиальное смещение

Kesici Uç
Insert
Пластина

Yedek Parçaları / Spare Parts / Залпасные части

Sıkma Vidası
Screw
Зажимной винт

Tork Anahtar
Torx Key
Торх Ключ

Takım Kodu Ordering Code Код для заказа	Stok Stock Наличие	Takım Ölçüleri (mm) Dimension (mm) Размеры (мм)							Maks. Ofset (radial) Max. Offset (radial) Радиальное смещение		Kesici Uç Insert Пластина	Sıkma Vidası Screw Зажимной винт	Tork Anahtar Torx Key Торх Ключ
		DC	DCON	DCSEMS	OAL	LU	LPR	LS	X _{max} [mm]	DC _{max} [mm]			
ATUM 30XD2 WCM. 06T308	●	30	32	44	147	60	87	60	2.4	34.8	WCM. 06T308	3010-M3.5x9	82-T10
ATUM 31XD2 WCM. 06T308	●	31	32	44	149	62	89	60	2.3	35.6			
ATUM 32XD2 WCM. 06T308	●	32	32	44	151	64	91	60	2.1	36.2			
ATUM 33XD2 WCM. 06T308	●	33	32	44	153	66	93	60	1.9	36.8			
ATUM 34XD2 WCM. 06T308	●	34	32	44	155	68	95	60	1.9	37.8			
ATUM 35XD2 WCM. 06T308	●	35	32	44	157	70	97	60	1.9	38.8			
ATUM 36XD2 WCM. 06T308	●	36	32	44	159	72	99	60	2	40			
ATUM 37XD2 WCM. 06T308	●	37	32	44	161	74	101	60	1.8	40.6			
ATUM 38XD2 WCM. 06T308	●	38	32	44	163	76	103	60	1.5	41			
ATUM 39XD2 WCM. 06T308	●	39	32	44	165	78	105	60	1.3	41.6			
ATUM 40XD2 WCM. 06T308	●	40	32	44	167	80	107	60	1	42			
ATUM 41XD2 WCM. 06T308	●	41	32	44	169	82	109	60	0.8	42.6			
ATUM 42XD2 WCM. 06T308	●	42	32	44	171	84	111	60	0.5	43			
ATUM 43XD2 WCM. 06T308	●	43	32	44	173	86	113	60	0.3	43.6			
ATUM 44XD2 WCM. 06T308	●	44	32	44	175	88	115	60	0	44			
ATUM 45XD2 WCM. 080412	●	45	40	54	192	90	122	70	3.3	51.6	WCM. 080412	4015-M4x11	80-T15
ATUM 46XD2 WCM. 080412	●	46	40	54	194	92	124	70	3	52			
ATUM 47XD2 WCM. 080412	●	47	40	54	196	94	126	70	2.8	52.6			
ATUM 48XD2 WCM. 080412	●	48	40	54	198	96	128	70	2.5	53			
ATUM 49XD2 WCM. 080412	●	49	40	54	200	98	130	70	2.2	53.4			
ATUM 50XD2 WCM. 080412	●	50	40	54	202	100	132	70	2	54			
ATUM 51XD2 WCM. 080412	●	51	40	54	204	102	134	70	1.8	54.6			
ATUM 52XD2 WCM. 080412	●	52	40	54	206	104	136	70	1.5	55			
ATUM 53XD2 WCM. 080412	●	53	40	54	208	106	138	70	1.3	55.6			
ATUM 54XD2 WCM. 080412	●	54	40	54	210	108	140	70	1	56			
ATUM 55XD2 WCM. 080412	●	55	40	54	212	110	142	70	0.8	56.6			
ATUM 56XD2 WCM. 080412	●	56	40	64	214	112	144	70	0.5	57			
ATUM 57XD2 WCM. 080412	●	57	40	64	216	114	146	70	0.3	57.6			
ATUM 58XD2 WCM. 080412	●	58	40	64	218	116	148	70	0	58			
ATUM 59XD2 WCM. 080412	●	59	40	64	220	118	150	70	0	59			
ATUM 60XD2 WCM. 080412	●	60	40	64	222	120	152	70	0	60			

R: Sağ / Right / Правый L: Sol / Left / Левый

● Stokta / In Stock / В наличии ○ Stokta Yok / Non Stock Item / Нет в наличии
ISO Ucuna Uygunudur. / Compatible with ISO Insert. / Под пластину ISO.

Sipariş Örneği/Ordering Example/Образец заказа

1 ad./pcs./шт. ATUM 30XD2 WCM. 06T308

Takma Uçlu Matkap Kullanım Kılavuzu : S 375 / User's Guide For U-Drills : P 375 / Руководство для эксплуатации сверел: стр. 375



Delme Derinliği = 3x Çap
Drilling Depth = 3x Diameter
Глубина сверления = 3x Диаметр

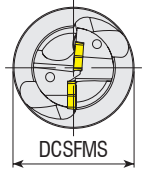
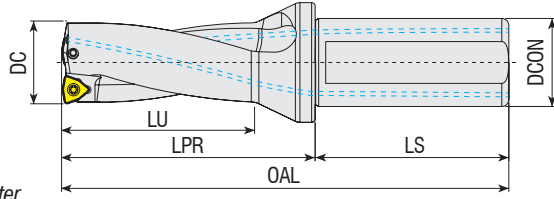

Takım Kodu Ordering Code Код для заказа	Stok Stock Наличие	Takım Ölçüleri (mm) Dimension (mm) Размеры (мм)							Maks. Ofset (radyal) Max. Offset (radial) Радиальное смещение		Kesici Uç Insert Пластина	Yedek Parçaları / Spare Parts / Запасные части	
		DC	DCON	DCSFMS	OAL	LU	LPR	LS	X _{max}	DC _{max} [mm]		Sıkma Vidası Screw Зажимной винт	Tork Anahtar Torx Key Торх Ключ
ATUM 16XD3 WCM. 030208	●	16	25	34	126	48	70	56	1.5	19	WCM. 030208	3008-M2.5x6	82-T08
ATUM 16.5XD3 WCM. 030208	●	16.5	25	34	126	48	70	56	1.5	19.5			
ATUM 17XD3 WCM. 030208	●	17	25	34	129	51	73	56	1.5	20			
ATUM 17.5XD3 WCM. 030208	●	17.5	25	34	129	51	73	56	1.5	20.5			
ATUM 18XD3 WCM. 030208	●	18	25	34	132	54	76	56	1.4	20.8			
ATUM 18.5XD3 WCM. 030208	●	18.5	25	34	132	54	76	56	1.3	21.1			
ATUM 19XD3 WCM. 030208	●	19	25	34	135	57	79	56	1.2	21.4			
ATUM 19.5XD3 WCM. 030208	●	19.5	25	34	135	57	79	56	1.2	21.9			
ATUM 20XD3 WCM. 040208	●	20	25	34	138	60	82	56	1.5	23	WCM. 040208	3008-M2.5x6	82-T08
ATUM 20.5XD3 WCM. 040208	●	20.5	25	34	138	60	82	56	1.5	23.5			
ATUM 21XD3 WCM. 040208	●	21	25	34	141	63	85	56	1	23			
ATUM 21.5XD3 WCM. 040208	●	21.5	25	34	141	63	85	56	1	23.5			
ATUM 22XD3 WCM. 040208	●	22	25	34	144	66	88	56	1	24			
ATUM 22.5XD3 WCM. 040208	●	22.5	25	34	144	66	88	56	1	24.5			
ATUM 23XD3 WCM. 040208	●	23	25	34	147	69	91	56	1	25			
ATUM 23.5XD3 WCM. 040208	●	23.5	25	34	147	69	91	56	1	25.5			
ATUM 24XD3 WCM. 050308	●	24	25	34	150	72	94	56	1.4	26.8	WCM. 050308	3008-M3x8	82-T08
ATUM 24.5XD3 WCM. 050308	●	24.5	25	34	150	72	94	56	1.4	27.3			
ATUM 25XD3 WCM. 050308	●	25	25	34	153	75	97	56	1.45	27.9			
ATUM 25.5XD3 WCM. 050308	●	25.5	25	34	153	75	97	56	1.45	28.4			
ATUM 26XD3 WCM. 050308	●	26	25	34	156	78	100	56	1.45	28.9			
ATUM 26.5XD3 WCM. 050308	●	26.5	25	34	156	78	100	56	1.45	29.4			
ATUM 27XD3 WCM. 050308	●	27	25	34	159	81	103	56	1.45	29.9			
ATUM 27.5XD3 WCM. 050308	●	27.5	25	34	159	81	103	56	1.45	30.4			
ATUM 28XD3 WCM. 050308	●	28	25	34	162	84	106	56	1.6	31.2	WCM. 06T308	3010-M3.5x9	82-T10
ATUM 28.5XD3 WCM. 050308	●	28.5	25	34	162	84	106	56	1.6	31.7			
ATUM 29XD3 WCM. 050308	●	29	25	34	165	87	109	56	1.65	32.3			
ATUM 29.5XD3 WCM. 050308	●	29.5	25	34	165	87	109	56	1.65	32.8			
ATUM 30XD3 WCM. 06T308	●	30	32	44	177	90	117	60	2.4	34.8			
ATUM 30.5XD3 WCM. 06T308	●	30.5	32	44	177	90	117	60	2.4	35.3			
ATUM 31XD3 WCM. 06T308	●	31	32	44	180	93	120	60	2.3	35.6			
ATUM 31.5XD3 WCM. 06T308	●	31.5	32	44	180	93	120	60	2.3	36.1			
ATUM 32XD3 WCM. 06T308	●	32	32	44	183	96	123	60	2.1	36.2			
ATUM 32.5XD3 WCM. 06T308	●	32.5	32	44	183	96	123	60	2.1	36.7			
ATUM 33XD3 WCM. 06T308	●	33	32	44	186	99	126	60	1.9	36.8			
ATUM 33.5XD3 WCM. 06T308	●	33.5	32	44	186	99	126	60	1.9	37.3			
ATUM 34XD3 WCM. 06T308	●	34	32	44	189	102	129	60	1.9	37.8			
ATUM 34.5XD3 WCM. 06T308	●	34.5	32	44	189	102	129	60	1.9	38.3			

R: Sağ / Right / Правый L: Sol / Left / Левый

● Stokta / In Stock / В наличии ○ Stokta Yok / Non Stock Item / Нет в наличии
ISO Uçuna Uygundur. / Compatible with ISO Insert. / Под пластину ISO.

Sipariş Örneği/Ordering Example/Образец заказа
1 ad./pcs./шт. ATUM 16XD3 WCM. 030208

Takma Uçlu Matkap Kullanım Kılavuzu : S 375 / User's Guide For U-Drills : P 375 / Руководство для эксплуатации сверел: стр. 375



Delme Derinliği = 3x Çap
Drilling Depth = 3x Diameter
Глубина сверления = 3x Диаметр

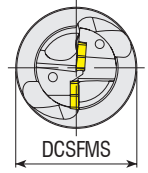
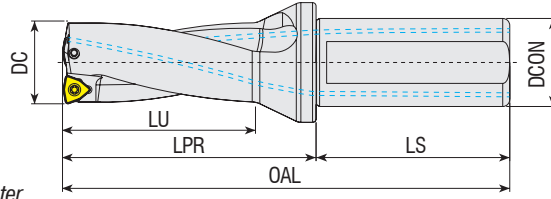

Takım Kodu
Ordering Code
Код для заказа

Stok
Stock
Наличие

Takım Ölçüleri (mm)
Dimension (mm)
Размеры (мм)

Maks. Ofset (radial)
Max. Offset (radial)
Радиальное смещение

Kesici Uç
Insert
Пластина

Yedek Parçaları / Spare Parts / Залпасные части

Sıkma Vidası
Screw
Зажимной винт

Tork Anahtar
Torx Key
Торх Ключ

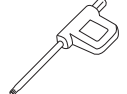

Takım Kodu Ordering Code Код для заказа	Stok Stock Наличие	Takım Ölçüleri (mm) Dimension (mm) Размеры (мм)							Maks. Ofset (radial) Max. Offset (radial) Радиальное смещение		Kesici Uç Insert Пластина	Sıkma Vidası Screw Зажимной винт	Tork Anahtar Torx Key Торх Ключ
		DC	DCON	DCSFMS	OAL	LU	LPR	LS	X _{max} X _{max} [mm]	DC _{max} DC _{max} [mm]			
ATUM 35XD3 WCM. 06T308	●	35	32	44	192	105	132	60	1.9	38.8	WCM. 06T308	3010-M3.5x9	82-T10
ATUM 35.5XD3 WCM. 06T308	●	35.5	32	44	192	105	132	60	1.9	39.3			
ATUM 36XD3 WCM. 06T308	●	36	32	44	195	108	135	60	2	40			
ATUM 36.5XD3 WCM. 06T308	●	36.5	32	44	195	108	135	60	2	40.5			
ATUM 37XD3 WCM. 06T308	●	37	32	44	198	111	138	60	1.8	40.6			
ATUM 37.5XD3 WCM. 06T308	●	37.5	32	44	198	111	138	60	1.8	41.1			
ATUM 38XD3 WCM. 06T308	●	38	32	44	201	114	141	60	1.5	41			
ATUM 38.5XD3 WCM. 06T308	●	38.5	32	44	201	114	141	60	1.5	41.5			
ATUM 39XD3 WCM. 06T308	●	39	32	44	204	117	144	60	1.3	41.6			
ATUM 39.5XD3 WCM. 06T308	●	39.5	32	44	204	117	144	60	1.3	42.1			
ATUM 40XD3 WCM. 06T308	●	40	32	44	207	120	147	60	1	42			
ATUM 40.5XD3 WCM. 06T308	●	40.5	32	44	207	120	147	60	1	42.5			
ATUM 41XD3 WCM. 06T308	●	41	32	44	210	123	150	60	0.8	42.6			
ATUM 41.5XD3 WCM. 06T308	●	41.5	32	44	210	123	150	60	0.8	43.1			
ATUM 42XD3 WCM. 06T308	●	42	32	44	213	126	153	60	0.5	43			
ATUM 42.5XD3 WCM. 06T308	●	42.5	32	44	213	126	153	60	0.5	43.5			
ATUM 43XD3 WCM. 06T308	●	43	32	44	216	129	156	60	0.3	43.6			
ATUM 43.5XD3 WCM. 06T308	●	43.5	32	44	216	129	156	60	0.3	44.1			
ATUM 44XD3 WCM. 06T308	●	44	32	44	219	132	159	60	0	44			
ATUM 44.5XD3 WCM. 06T308	●	44.5	32	44	219	132	159	60	0	44.5			
ATUM 45XD3 WCM. 080412	●	45	40	54	237	135	167	70	3.3	51.6	WCM. 080412	4015-M4x11	80-T15
ATUM 45.5XD3 WCM. 080412	●	45.5	40	54	237	135	167	70	3.3	52.1			
ATUM 46XD3 WCM. 080412	●	46	40	54	240	138	170	70	3	52			
ATUM 47XD3 WCM. 080412	●	47	40	54	243	141	173	70	2.8	52.6			
ATUM 48XD3 WCM. 080412	●	48	40	54	246	144	176	70	2.5	53			
ATUM 49XD3 WCM. 080412	●	49	40	54	249	147	179	70	2.2	53.4			
ATUM 50XD3 WCM. 080412	●	50	40	54	252	150	182	70	2	54			
ATUM 51XD3 WCM. 080412	●	51	40	54	255	153	185	70	1.8	54.6			
ATUM 52XD3 WCM. 080412	●	52	40	54	258	156	188	70	1.5	55			
ATUM 53XD3 WCM. 080412	●	53	40	54	261	159	191	70	1.3	55.6			
ATUM 54XD3 WCM. 080412	●	54	40	54	264	162	194	70	1	56			
ATUM 55XD3 WCM. 080412	●	55	40	54	267	165	197	70	0.8	56.6			
ATUM 56XD3 WCM. 080412	●	56	40	64	270	168	200	70	0.5	57			
ATUM 57XD3 WCM. 080412	●	57	40	64	273	171	203	70	0.3	57.6			
ATUM 58XD3 WCM. 080412	●	58	40	64	276	174	206	70	0	58			
ATUM 59XD3 WCM. 080412	●	59	40	64	279	177	209	70	0	59			
ATUM 60XD3 WCM. 080412	●	60	40	64	282	180	212	70	0	60			

R: Sağ / Right / Правый L: Sol / Left / Левый

● Stokta / In Stock / В наличии ○ Stokta Yok / Non Stock Item / Нет в наличии
ISO Ucsuna Uygundur. / Compatible with ISO Insert. / Под пластину ISO.

Sipariş Örneği/Ordering Example/Образец заказа
1 ad./pcs./шт. ATUM 35XD3 WCM. 06T308

Takma Uçlu Matkap Kullanım Kılavuzu : S 375 / User's Guide For U-Drills : P 375
Руководство для эксплуатации сверел: стр. 375



Delme Derinliği = 4x Çap
Drilling Depth = 4x Diameter
Глубина сверления = 4x Диаметр

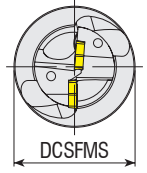
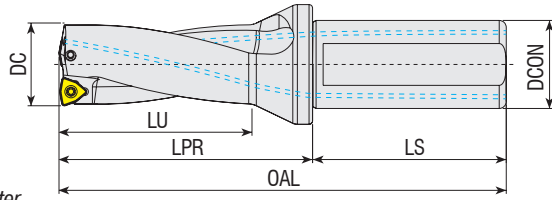

Takım Kodu Ordering Code Код для заказа	Stok Stock Наличие	Takım Ölçüleri (mm) Dimension (mm) Размеры (мм)							Maks. Ofset (radyal) Max. Offset (radial) Радиальное смещение	Kesici Uç Insert Пластина	Yedek Parçaları / Spare Parts / Запасные части		
		DC	DCON	DCSFMS	OAL	LU	LPR	LS			Sıkma Vidası Screw Зажимной винт	Tork Anahtar Torx Key Торх Ключ	
ATUM 16XD4 WCM. 030208	●	16	25	34	142	64	86	56	1.5	19	WCM. 030208		
ATUM 16.5XD4 WCM. 030208	○	16.5	25	34	142	64	86	56	1.5	19.5			
ATUM 17XD4 WCM. 030208	●	17	25	34	146	68	90	56	1.5	20			
ATUM 17.5XD4 WCM. 030208	●	17.5	25	34	146	68	90	56	1.5	20.5			
ATUM 18XD4 WCM. 030208	●	18	25	34	150	72	94	56	1.4	20.8			
ATUM 18.5XD4 WCM. 030208	○	18.5	25	34	150	72	94	56	1.3	21.1			
ATUM 19XD4 WCM. 030208	●	19	25	34	154	76	98	56	1.2	21.4			
ATUM 19.5XD4 WCM. 030208	○	19.5	25	34	154	76	98	56	1.2	21.9			
ATUM 20XD4 WCM. 040208	●	20	25	34	158	80	102	56	1.5	23	WCM. 040208	3008-M2.5x6	82-T08
ATUM 20.5XD4 WCM. 040208	○	20.5	25	34	158	80	102	56	1.5	23.5			
ATUM 21XD4 WCM. 040208	●	21	25	34	162	84	106	56	1	23			
ATUM 21.5XD4 WCM. 040208	○	21.5	25	34	162	84	106	56	1	23.5			
ATUM 22XD4 WCM. 040208	●	22	25	34	166	88	110	56	1	24			
ATUM 22.5XD4 WCM. 040208	●	22.5	25	34	166	88	110	56	1	24.5			
ATUM 23XD4 WCM. 040208	●	23	25	34	170	92	114	56	1	25			
ATUM 23.5XD4 WCM. 040208	○	23.5	25	34	170	92	114	56	1	25.5			
ATUM 24XD4 WCM. 050308	●	24	25	34	174	96	118	56	1.4	26.8	WCM. 050308	3008-M3x8	
ATUM 24.5XD4 WCM. 050308	○	24.5	25	34	174	96	118	56	1.4	27.3			
ATUM 25XD4 WCM. 050308	●	25	25	34	178	100	122	56	1.45	27.9			
ATUM 25.5XD4 WCM. 050308	○	25.5	25	34	178	100	122	56	1.45	28.4			
ATUM 26XD4 WCM. 050308	●	26	25	34	182	104	126	56	1.45	28.9			
ATUM 26.5XD4 WCM. 050308	●	26.5	25	34	182	104	126	56	1.45	29.4			
ATUM 27XD4 WCM. 050308	●	27	25	34	186	108	130	56	1.45	29.9			
ATUM 27.5XD4 WCM. 050308	○	27.5	25	34	186	108	130	56	1.45	30.4			
ATUM 28XD4 WCM. 050308	●	28	25	34	190	112	134	56	1.6	31.2			
ATUM 28.5XD4 WCM. 050308	●	28.5	25	34	190	112	134	56	1.6	31.7			
ATUM 29XD4 WCM. 050308	●	29	25	34	194	116	138	56	1.65	32.3			
ATUM 29.5XD4 WCM. 050308	○	29.5	25	34	194	116	138	56	1.65	32.8			

R: Sağ / Right / Правый L: Sol / Left / Левый
● Stokta / In Stock / В наличии ○ Stokta Yok / Non Stock Item / Нет в наличии
ISO Ucuna Uygundur. / Compatible with ISO Insert. / Под пластину ISO.

Sipariş Örneği/Ordering Example/Образец заказа
1 ad./pcs./шт. ATUM 16XD4 WCM. 030208

Takma Uçlu Matkap Kullanım Kılavuzu : S 375 / User's Guide For U-Drills : P 375 / Руководство для эксплуатации сверел: стр. 375



Delme Derinliği = 4x Çap
Drilling Depth = 4x Diameter
Глубина сверления = 4x Диаметр

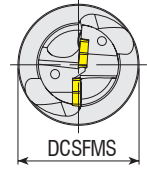
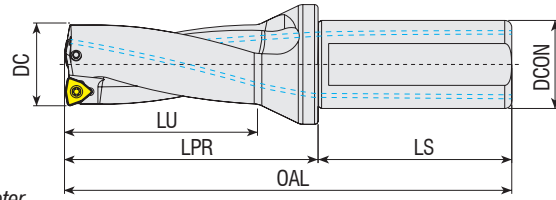

Takım Kodu
Ordering Code
Код для заказа

Stok
Stock
Наличие

Takım Ölçüleri (mm)
Dimension (mm)
Размеры (мм)

Maks. Ofset (radyal)
Max. Offset (radial)
Радиальное смещение

Kesici Uç
Insert
Пластина

Yedek Parçaları / Spare Parts / Запасные части

Sıkma Vidası
Screw
Зажимной винт

Tork Anahtar
Torx Key
Торх Ключ



Takım Kodu Ordering Code Код для заказа	Stok Stock Наличие	Takım Ölçüleri (mm) Dimension (mm) Размеры (мм)							Maks. Ofset (radyal) Max. Offset (radial) Радиальное смещение		Kesici Uç Insert Пластина	Sıkma Vidası Screw Зажимной винт	Tork Anahtar Torx Key Торх Ключ
		DC	DCON	DCSFMS	OAL	LU	LPR	LS	X _{max} [mm]	DC _{max} [mm]			
ATUM 30XD4 WCM. 06T308	●	30	32	44	207	120	147	60	2.4	34.8	WCM. 06T308	3010-M3.5x9	82-T10
ATUM 31XD4 WCM. 06T308	●	31	32	44	211	124	151	60	2.3	35.6			
ATUM 32XD4 WCM. 06T308	●	32	32	44	215	128	155	60	2.1	36.2			
ATUM 33XD4 WCM. 06T308	●	33	32	44	219	132	159	60	1.9	36.8			
ATUM 33.5XD4 WCM. 06T308	●	33.5	32	44	219	132	159	60	1.9	37.3			
ATUM 34XD4 WCM. 06T308	●	34	32	44	223	136	163	60	1.9	37.8			
ATUM 35XD4 WCM. 06T308	●	35	32	44	227	140	167	60	1.9	38.8			
ATUM 36XD4 WCM. 06T308	●	36	32	44	231	144	171	60	2	40			
ATUM 37XD4 WCM. 06T308	●	37	32	44	235	148	175	60	1.8	40.6			
ATUM 38XD4 WCM. 06T308	●	38	32	44	239	152	179	60	1.5	41			
ATUM 38.5XD4 WCM. 06T308	●	38.5	32	44	239	152	179	60	1.5	41.5			
ATUM 39XD4 WCM. 06T308	●	39	32	44	243	156	183	60	1.3	41.6			
ATUM 40XD4 WCM. 06T308	●	40	32	44	247	160	187	60	1	42			
ATUM 41XD4 WCM. 06T308	●	41	32	44	251	164	191	60	0.8	42.6			
ATUM 42XD4 WCM. 06T308	●	42	32	44	255	168	195	60	0.5	43			
ATUM 43XD4 WCM. 06T308	●	43	32	44	259	172	199	60	0.3	43.6			
ATUM 44XD4 WCM. 06T308	●	44	32	44	263	176	203	60	0	44			
ATUM 45XD4 WCM. 080412	●	45	40	54	282	180	212	70	3.3	51.6	WCM. 080412	4015-M4x11	80-T15
ATUM 46XD4 WCM. 080412	●	46	40	54	286	184	216	70	3	52			
ATUM 47XD4 WCM. 080412	●	47	40	54	290	188	220	70	2.8	52.6			
ATUM 48XD4 WCM. 080412	●	48	40	54	294	192	224	70	2.5	53			
ATUM 49XD4 WCM. 080412	●	49	40	54	298	196	228	70	2.2	53.4			
ATUM 50XD4 WCM. 080412	●	50	40	54	302	200	232	70	2	54			

R: Sağ / Right / Правый L: Sol / Left / Левый
● Stokta / In Stock / В наличии ○ Stokta Yok / Non Stock Item / Нет в наличии
ISO Ucuna Uygunudur. / Compatible with ISO Insert. / Под пластину ISO.

Sipariş Örneği/Ordering Example/Образец заказа
1 ad./pcs./шт. ATUM 30XD4 WCM. 06T308
Takma Uçlu Matkap Kullanım Kılavuzu : S 375 / User's Guide For U-Drills : P 375 / Руководство
для эксплуатации сверел: стр. 375



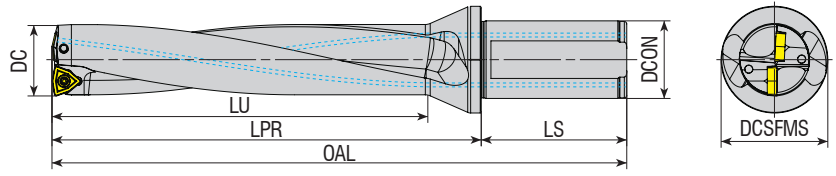

Delme Derinliği = 5x Çap
Drilling Depth = 5x Diameter
Глубина сверления = 5x Диаметр

Takım Kodu Ordering Code Код для заказа	Stok Stock Наличие	Takım Ölçüleri (mm) Dimension (mm) Размеры (мм)							Maks. Ofset (radyal) Max. Offset (radial) Радиальное смещение		Kesici Uç Insert Пластина	Yedek Parçaları / Spare Parts / Запасные части	
		DC	DCON	DCFSMS	OAL	LU	LPR	LS	X _{max} X _{max} [mm]	DC _{max} DC _{max} [mm]		Sıkma Vidası Screw Зажимной винт	Tork Anahtar Torx Key Торх Ключ
ATUM 20XD5 WCM. 040208	●	20	25	34	178	100	122	56	1.5	23	WCM. 040208	3008-M2.5x6	82-T08
ATUM 21XD5 WCM. 040208	●	21	25	34	183	105	127	56	1	23			
ATUM 22XD5 WCM. 040208	●	22	25	34	188	110	132	56	1	24			
ATUM 23XD5 WCM. 040208	●	23	25	34	193	115	137	56	1	25			
ATUM 24XD5 WCM. 050308	●	24	25	34	198	120	142	56	1.4	26.8	WCM. 050308	3008-M3x8	82-T08
ATUM 25XD5 WCM. 050308	●	25	25	34	203	125	147	56	1.45	27.9			
ATUM 26XD5 WCM. 050308	●	26	25	34	208	130	152	56	1.45	28.9			
ATUM 27XD5 WCM. 050308	●	27	25	34	213	135	157	56	1.45	29.9			
ATUM 28XD5 WCM. 050308	●	28	25	34	218	140	162	56	1.6	31.2			
ATUM 29XD5 WCM. 050308	●	29	25	34	223	145	167	56	1.65	32.3			
ATUM 30XD5 WCM. 06T308	●	30	32	44	237	150	177	60	2.4	34.8	WCM. 06T308	3010-M3.5x9	82-T10
ATUM 31XD5 WCM. 06T308	●	31	32	44	242	155	182	60	2.3	35.6			
ATUM 32XD5 WCM. 06T308	●	32	32	44	247	160	187	60	2.1	36.2			
ATUM 33XD5 WCM. 06T308	●	33	32	44	252	165	192	60	1.9	36.8			
ATUM 34XD5 WCM. 06T308	●	34	32	44	257	170	197	60	1.9	37.8			
ATUM 35XD5 WCM. 06T308	●	35	32	44	262	175	202	60	1.9	38.8			
ATUM 37XD5 WCM. 06T308	●	37	32	44	272	185	212	60	1.8	40.6			
ATUM 38XD5 WCM. 06T308	●	38	32	44	277	190	217	60	1.5	41			
ATUM 46XD5 WCM. 080412	●	46	40	54	332	230	262	70	3	52	WCM. 080412	4015-M4x11	80-T15

R: Sağ / Right / Правый L: Sol / Left / Левый

● Stokta / In Stock / В наличии ○ Stokta Yok / Non Stock Item / Нет в наличии

ISO Uçuna Uygundur. / Compatible with ISO Insert. / Под пластину ISO.



Delme Derinliği = 2x Çap
Drilling Depth = 2x Diameter
Глубина сверления = 2x Диаметр

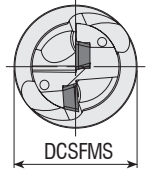
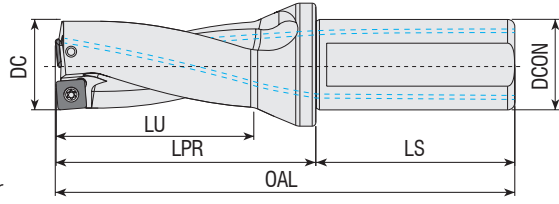

Takım Kodu Ordering Code Код для заказа	Stok Stock Наличие	Takım Ölçüleri (mm) Dimension (mm) Размеры (мм)								Maks. Ofset (radyal) Max. Offset (radial) Радиальное смещение	Kesici Uç Insert Пластина	Yedek Parçaları / Spare Parts / Запасные части		
		DC	DCON	DCSFMS	OAL	LU	LPR	LS	Sıkma Vidası Screw Зажимной винт			Tork Anahtar Torx Key Торх Ключ		
ATUM 12.5XD2 SP. 050204	●	12.5	20	25	96	24	46	50	0.75	14	SP. 050204	3006-M2x4	82-T06	
ATUM 13XD2 SP. 050204	●	13	20	25	98	26	48	50	0.75	14.5				
ATUM 13.5XD2 SP. 050204	●	13.5	20	25	98	26	48	50	0.75	15				
ATUM 14XD2 SP. 050204	●	14	20	25	100	28	50	50	0.6	15.2				
ATUM 14.5XD2 SP. 050204	●	14.5	20	25	100	28	50	50	0.6	15.7				
ATUM 15XD2 SP. 050204	●	15	20	25	102	30	52	50	0.5	16				
ATUM 15.5XD2 SP. 060204	●	15.5	20	25	102	30	52	50	0.9	17.3	SP. 060204	3007-M2.2x4.6	82-T07	
ATUM 16XD2 SP. 060204	●	16	25	34	110	32	54	56	0.8	17.6				
ATUM 16.5XD2 SP. 060204	●	16.5	25	34	110	32	54	56	0.8	18.1				
ATUM 17XD2 SP. 060204	●	17	25	34	112	34	56	56	0.75	18.5				
ATUM 17.5XD2 SP. 060204	●	17.5	25	34	112	34	56	56	0.75	19				
ATUM 18XD2 SP. 060204	●	18	25	34	114	36	58	56	0.5	19				
ATUM 18.5XD2 SP. 060204	●	18.5	25	34	114	36	58	56	0.5	19.5				
ATUM 19XD2 SP. 060204	●	19	25	34	116	38	60	56	0.3	19.6				
ATUM 19.5XD2 SP. 060204	●	19.5	25	34	116	38	60	56	0.3	20.1				
ATUM 20XD2 SP. 060204	●	20	25	34	118	40	62	56	0	20				
ATUM 20.5XD2 SP. 060204	●	20.5	25	34	118	40	62	56	0	20.5				
ATUM 21XD2 SP. 060204	●	21	25	34	120	42	64	56	0	21				
ATUM 21.5XD2 SP. 060204	●	21.5	25	34	120	42	64	56	0	21.5				
ATUM 22XD2 SP. 07T308	●	22	25	34	122	44	66	56	1	24	SP. 07T308	3008-M2.5x6	82-T08	
new ATUM 22XD2 SP. 07T308-32	●	22	32	44	131	44	71	60	1	24				
ATUM 22.5XD2 SP. 07T308	●	22.5	25	34	122	44	66	56	1	24.5				
ATUM 23XD2 SP. 07T308	●	23	25	34	124	46	68	56	0.75	24.5				
new ATUM 23XD2 SP. 07T308-32	●	23	32	44	133	46	73	60	0.75	24.5				
ATUM 23.5XD2 SP. 07T308	●	23.5	25	34	124	46	68	56	0.75	25				
ATUM 24XD2 SP. 07T308	●	24	25	34	126	48	70	56	0.5	25				
new ATUM 24XD2 SP. 07T308-32	●	24	32	44	135	48	75	60	0.50	25				
ATUM 24.5XD2 SP. 07T308	●	24.5	25	34	126	48	70	56	0.5	25.5				
ATUM 25XD2 SP. 07T308	●	25	25	34	128	50	72	56	0.25	25.5				
new ATUM 25XD2 SP. 07T308-32	●	25	32	44	137	50	77	60	0.25	25.5				
ATUM 25.5XD2 SP. 07T308	●	25.5	25	34	128	50	72	56	0.25	26				
ATUM 26XD2 SP. 07T308	●	26	25	34	130	52	74	56	0	26				
new ATUM 26XD2 SP. 07T308-32	●	26	32	44	139	52	79	60	0	26				
ATUM 26.5XD2 SP. 07T308	●	26.5	25	34	130	52	74	56	0	26.5				
ATUM 27XD2 SP. 07T308	●	27	25	34	132	54	76	56	0	27				
new ATUM 27XD2 SP. 07T308-32	●	27	32	44	141	54	81	60	0	27				
ATUM 27.5XD2 SP. 07T308	●	27.5	25	34	132	54	76	56	0	27.5				

R: Sağ / Right / Правый L: Sol / Left / Левый
● Stokta / In Stock / В наличии ○ Stokta Yok / Non Stock Item / Нет в наличии
TGTC Ucuna Uygunudur. / Compatible with TGTC Insert. / Под пластину TGTC.

Sipariş Örneği/Ordering Example/Образец заказа
1 ad./pcs./шт. ATUM 12.5XD2 SP. 050204
Takma Uçlu Matkap Kullanım Kılavuzu : S 375 / User's Guide For U-Drills : P 375
Руководство для эксплуатации сверел: стр. 375



Delme Derinliği = 2x Çap
Drilling Depth = 2x Diameter
Глубина сверления = 2x Диаметр

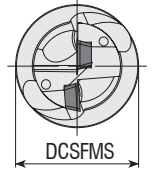
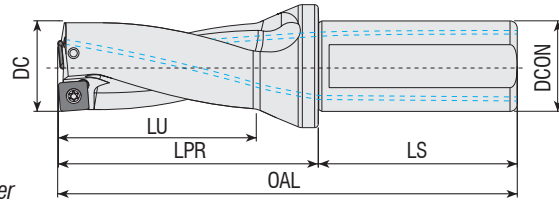

Takım Kodu Ordering Code Код для заказа	Stok Stock Наличие	Takım Ölçüleri (mm) Dimension (mm) Размеры (мм)								Maks. Ofset (radyal) Max. Offset (radial) Радиальное смещение	Kesici Uç Insert Пластина	Yedek Parçaları / Spare Parts / Запасные части	
		DC	DCON	DCSFMS	OAL	LU	LPR	LS	Sıkma Vidası Screw Зажимной винт			Tork Anahtar Torx Key Торх Ключ	
ATUM 28XD2 SP. 090408	●	28	25	34	134	56	78	56	1	30	SP. 090408	4015-M3.5x9	80-T15
new ATUM 28XD2 SP. 090408-32	●	28	32	44	143	56	83	60	1	29			
ATUM 28.5XD2 SP. 090408	●	28.5	25	34	134	56	78	56	1	30.5			
ATUM 29XD2 SP. 090408	●	29	25	34	136	58	80	56	0.75	30.5			
new ATUM 29XD2 SP. 090408-32	●	29	32	44	145	58	85	60	0.75	30.5			
ATUM 29.5XD2 SP. 090408	●	29.5	25	34	136	58	80	56	0.75	31			
ATUM 30XD2 SP. 090408	●	30	32	44	147	60	87	60	0.5	31			
ATUM 31XD2 SP. 090408	●	31	32	44	149	62	89	60	0.25	31.5			
ATUM 32XD2 SP. 090408	●	32	32	44	151	64	91	60	0	32			
ATUM 33XD2 SP. 090408	●	33	32	44	153	66	93	60	0	33			
ATUM 34XD2 SP. 110408	●	34	32	44	155	68	95	60	1	36	SP. 110408	4015-M4x11	80-T15
ATUM 35XD2 SP. 110408	●	35	32	44	157	70	97	60	0.75	36.5			
ATUM 36XD2 SP. 110408	●	36	32	44	159	72	99	60	0.6	37.2			
ATUM 37XD2 SP. 110408	●	37	32	44	161	74	101	60	0.5	38			
ATUM 38XD2 SP. 110408	●	38	32	44	163	76	103	60	0.25	38.5			
ATUM 39XD2 SP. 110408	●	39	32	44	165	78	105	60	0	39			
ATUM 40XD2 SP. 110408	●	40	32	44	167	80	107	60	0	40			
ATUM 41XD2 SP. 110408	●	41	32	44	169	82	109	60	0	41			
ATUM 42XD2 SP. 140512	●	42	32	44	171	84	111	60	1.2	44.4	SP. 140512	1020-M5x11	80-T20
ATUM 43XD2 SP. 140512	●	43	32	44	173	86	113	60	1	45			
ATUM 44XD2 SP. 140512	●	44	32	44	175	88	115	60	0.8	45.6			
ATUM 45XD2 SP. 140512	●	45	40	54	192	90	122	70	0.6	46.2			
ATUM 46XD2 SP. 140512	●	46	40	54	194	92	124	70	0.4	46.8			
ATUM 47XD2 SP. 140512	●	47	40	54	196	94	126	70	0.2	47.4			
ATUM 48XD2 SP. 140512	●	48	40	54	198	96	128	70	0	48			
ATUM 49XD2 SP. 140512	●	49	40	54	200	98	130	70	0	49			
ATUM 50XD2 SP. 140512	●	50	40	54	202	100	132	70	0	50			

R: Sağ / Right / Правый L: Sol / Left / Левый
● Stokta / In Stock / В наличии ○ Stokta Yok / Non Stock Item / Нет в наличии
TGTC Ucuna Uygunudur. / Compatible with TGTC Insert. / Под пластину TGTC.

Sipariş Örneği/Ordering Example/Образец заказа
1 ad./pcs./шт. ATUM 28XD2 SP. 090408

Takma Uçlu Matkap Kullanım Kılavuzu : S 375 / User's Guide For U-Drills : P 375
Руководство для эксплуатации сверел: стр. 375



Delme Derinliği = 3x Çap
Drilling Depth = 3x Diameter
Глубина сверления = 3x Диаметр

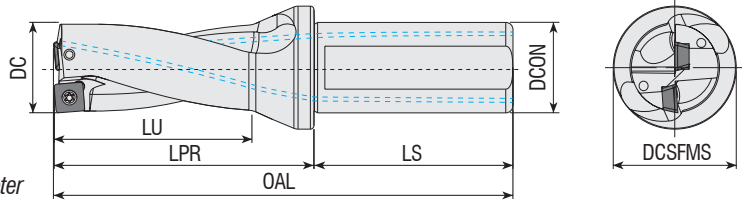

Takım Kodu
Ordering Code
Код для заказа

Stok
Stock
Наличие

Takım Ölçüleri (mm)
Dimension (mm)
Размеры (мм)

Maks. Ofset (radyal)
Max. Offset (radial)
Радиальное смещение

Kesici Uç
Insert
Пластина

Yedek Parçaları / Spare Parts / Запасные части

Sıkma Vidası
Screw
Зажимной винт

Tork Anahtar
Torx Key
Торх Ключ

DC DCON DCSFMS OAL LU LPR LS X_{max} DC_{max}



	DC	DCON	DCSFMS	OAL	LU	LPR	LS	X _{max}	DC _{max}				
ATUM 12.5XD3 SP. 050204	●	12.5	20	25	108	36	58	50	0.75	14	SP. 050204	3006-M2x4	82-T06
ATUM 13XD3 SP. 050204	●	13	20	25	111	39	61	50	0.75	14.5			
ATUM 13.5XD3 SP. 050204	●	13.5	20	25	111	39	61	50	0.75	15			
ATUM 14XD3 SP. 050204	●	14	20	25	114	42	64	50	0.6	15.2			
ATUM 14.5XD3 SP. 050204	●	14.5	20	25	114	42	64	50	0.6	15.7			
ATUM 15XD3 SP. 050204	●	15	20	25	117	45	67	50	0.5	16			
ATUM 15.5XD3 SP. 060204	●	15.5	20	25	117	45	67	50	0.9	17.3	SP. 060204	3007-M2.2x4.6	82-T07
ATUM 16XD3 SP. 060204	●	16	25	34	126	48	70	56	0.8	17.6			
ATUM 16.5XD3 SP. 060204	●	16.5	25	34	126	48	70	56	0.8	18.1			
ATUM 17XD3 SP. 060204	●	17	25	34	129	51	73	56	0.75	18.5			
ATUM 17.5XD3 SP. 060204	●	17.5	25	34	129	51	73	56	0.75	19			
ATUM 18XD3 SP. 060204	●	18	25	34	132	54	76	56	0.5	19			
ATUM 18.5XD3 SP. 060204	●	18.5	25	34	132	54	76	56	0.5	19.5			
ATUM 19XD3 SP. 060204	●	19	25	34	135	57	79	56	0.3	19.6			
ATUM 19.5XD3 SP. 060204	●	19.5	25	34	135	57	79	56	0.3	20.1			
ATUM 20XD3 SP. 060204	●	20	25	34	138	60	82	56	0	20			
ATUM 20.5XD3 SP. 060204	●	20.5	25	34	138	60	82	56	0	20.5			
ATUM 21XD3 SP. 060204	●	21	25	34	141	63	85	56	0	21			
ATUM 21.5XD3 SP. 060204	●	21.5	25	34	141	63	85	56	0	21.5			
ATUM 22XD3 SP. 07T308	●	22	25	34	144	66	88	56	1	24	SP. 07T308	3008-M2.5x6	82-T08
new ATUM 22XD3 SP. 07T308-32	●	22	32	44	153	66	93	60	1	23			
ATUM 22.5XD3 SP. 07T308	●	22.5	25	34	144	66	88	56	1	24.5			
ATUM 23XD3 SP. 07T308	●	23	25	34	147	69	91	56	0.75	24.5			
new ATUM 23XD3 SP. 07T308-32	●	23	32	44	156	69	96	60	0.75	24.5			
ATUM 23.5XD3 SP. 07T308	●	23.5	25	34	147	69	91	56	0.75	25			
ATUM 24XD3 SP. 07T308	●	24	25	34	150	72	94	56	0.5	25			
new ATUM 24XD3 SP. 07T308-32	●	24	32	44	159	72	99	60	0.50	25			
ATUM 24.5XD3 SP. 07T308	●	24.5	25	34	150	72	94	56	0.5	25.5			
ATUM 25XD3 SP. 07T308	●	25	25	34	153	75	97	56	0.25	25.5			
new ATUM 25XD3 SP. 07T308-32	●	25	32	44	162	75	102	60	0.25	25.5			
ATUM 25.5XD3 SP. 07T308	●	25.5	25	34	153	75	97	56	0.25	26			
ATUM 26XD3 SP. 07T308	●	26	25	34	156	78	100	56	0	26			
new ATUM 26XD3 SP. 07T308-32	●	26	32	44	165	78	105	60	0	26			
ATUM 26.5XD3 SP. 07T308	●	26.5	25	34	156	78	100	56	0	26.5			
ATUM 27XD3 SP. 07T308	●	27	25	34	159	81	103	56	0	27			
new ATUM 27XD3 SP. 07T308-32	●	27	32	44	168	81	108	60	0	27			
ATUM 27.5XD3 SP. 07T308	●	27.5	25	34	159	81	103	56	0	27.5			
ATUM 28XD3 SP. 090408	●	28	25	34	162	84	106	56	1	30	SP. 090408	4015-M3.5x9	80-T15
new ATUM 28XD3 SP. 090408-32	●	28	32	44	171	84	111	60	1	29			
ATUM 28.5XD3 SP. 090408	●	28.5	25	34	162	84	106	56	1	30.5			
ATUM 29XD3 SP. 090408	●	29	25	34	165	87	109	56	0.75	30.5			
new ATUM 29XD3 SP. 090408-32	●	29	32	44	174	87	114	6	0.75	30.5			
ATUM 29.5XD3 SP. 090408	●	29.5	25	34	165	87	109	56	0.75	31			
ATUM 30XD3 SP. 090408	●	30	32	44	177	90	117	60	0.5	31			
ATUM 30.5XD3 SP. 090408	●	30.5	32	44	177	90	117	60	0.5	31.5			
ATUM 31XD3 SP. 090408	●	31	32	44	180	93	120	60	0.25	31.5			
ATUM 31.5XD3 SP. 090408	●	31.5	32	44	180	93	120	60	0.25	32			
ATUM 32XD3 SP. 090408	●	32	32	44	183	96	123	60	0	32			
ATUM 32.5XD3 SP. 090408	●	32.5	32	44	183	96	123	60	0	32.5			
ATUM 33XD3 SP. 090408	●	33	32	44	186	99	126	60	0	33			
ATUM 33.5XD3 SP. 090408	●	33.5	32	44	186	99	126	60	0	33.5			

R: Sağ / Right / Правый L: Sol / Left / Левый

● Stokta / In Stock / В наличии ○ Stokta Yok / Non Stock Item / Нет в наличии

TGTC Ucuna Uygundur. / Compatible with TGTC Insert. / Под пластину TGTC.

Sipariş Örneği/Ordering Example/Образец заказа

1 ad./pcs./шт. ATUM 12.5XD3 SP. 050204

Takma Uçlu Matkap Kullanım Kılavuzu : S 375 / User's Guide For U-Drills : P 375

Руководство для эксплуатации сверел: стр. 375



Delme Derinliği = 3x Çap
Drilling Depth = 3x Diameter
Глубина сверления = 3x Диаметр

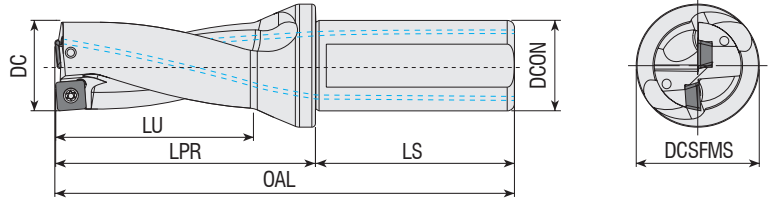

Takım Kodu Ordering Code Код для заказа	Stok Stock Наличие	Takım Ölçüleri (mm) Dimension (mm) Размеры (мм)								Maks. Ofset (radyal) Max. Offset (radial) Радиальное смещение		Kesici Uç Insert Пластина	Yedek Parçaları / Spare Parts / Залпасные части		
		DC	DCON	DCSFMS	OAL	LU	LPR	LS	X _{max} [mm]	DC _{max} [mm]	Sıkma Vidası Screw Зажимной винт		Tork Anahtar Torx Key Торх Ключ		
ATUM 34XD3 SP. 110408	●	34	32	44	189	102	129	60	1	36	SP. 110408	4015-M4x11	80-T15		
ATUM 34.5XD3 SP. 110408	●	34.5	32	44	189	102	129	60	1	36.5					
ATUM 35XD3 SP. 110408	●	35	32	44	192	105	132	60	0.75	36.5					
ATUM 35.5XD3 SP. 110408	●	35.5	32	44	192	105	132	60	0.75	37					
ATUM 36XD3 SP. 110408	●	36	32	44	195	108	135	60	0.6	37.2					
ATUM 36.5XD3 SP. 110408	●	36.5	32	44	195	108	135	60	0.6	37.7					
ATUM 37XD3 SP. 110408	●	37	32	44	198	111	138	60	0.5	38					
ATUM 37.5XD3 SP. 110408	●	37.5	32	44	198	111	138	60	0.5	38.5					
ATUM 38XD3 SP. 110408	●	38	32	44	201	114	141	60	0.25	38.5					
ATUM 38.5XD3 SP. 110408	●	38.5	32	44	201	114	141	60	0.25	39					
ATUM 39XD3 SP. 110408	●	39	32	44	204	117	144	60	0	39					
ATUM 39.5XD3 SP. 110408	●	39.5	32	44	204	117	144	60	0	39.5					
ATUM 40XD3 SP. 110408	●	40	32	44	207	120	147	60	0	40					
ATUM 40.5XD3 SP. 110408	●	40.5	32	44	207	120	147	60	0	40.5					
ATUM 41XD3 SP. 110408	●	41	32	44	210	123	150	60	0	41					
ATUM 41.5XD3 SP. 110408	●	41.5	32	44	210	123	150	60	0	41.5					
ATUM 42XD3 SP. 140512	●	42	32	44	213	126	153	60	1.2	44.4	SP. 140512	1020-M5x11	80-T20		
ATUM 42.5XD3 SP. 140512	●	42.5	32	44	213	126	153	60	1.2	44.9					
ATUM 43XD3 SP. 140512	●	43	32	44	216	129	156	60	1	45					
ATUM 43.5XD3 SP. 140512	●	43.5	32	44	216	129	156	60	1	45.5					
ATUM 44XD3 SP. 140512	●	44	32	44	219	132	159	60	0.8	45.6					
ATUM 44.5XD3 SP. 140512	●	44.5	32	44	219	132	159	60	0.8	46.1					
ATUM 45XD3 SP. 140512	●	45	40	54	237	135	167	70	0.6	46.2					
ATUM 45.5XD3 SP. 140512	●	45.5	40	54	237	135	167	70	0.6	46.7					
ATUM 46XD3 SP. 140512	●	46	40	54	240	138	170	70	0.4	46.8					
ATUM 47XD3 SP. 140512	●	47	40	54	243	141	173	70	0.2	47.4					
ATUM 48XD3 SP. 140512	●	48	40	54	246	144	176	70	0	48					
ATUM 49XD3 SP. 140512	●	49	40	54	249	147	179	70	0	49					
ATUM 50XD3 SP. 140512	●	50	40	54	252	150	182	70	0	50					
ATUM 51XD3 SP. 140512	●	51	40	54	255	153	185	70	0	51					
ATUM 52XD3 SP. 140512	●	52	40	54	258	156	188	70	0	52					

R: Sağ / Right / Правый L: Sol / Left / Левый
● Stokta / In Stock / В наличии ○ Stokta Yok / Non Stock Item / Нет в наличии
TGTC Ucuna Uygundur. / Compatible with TGTC Insert. / Под пластину TGTC.

Sipariş Örneği/Ordering Example/Образец заказа
1 ad./pcs./шт. ATUM 34XD3 SP. 110408
Takma Uçlu Matkap Kullanım Kılavuzu : S 375 / User's Guide For U-Drills : P 375
Руководство для эксплуатации сверел: стр. 375



Delme Derinliği = 4x Çap
Drilling Depth = 4x Diameter
Глубина сверления = 4x Диаметр

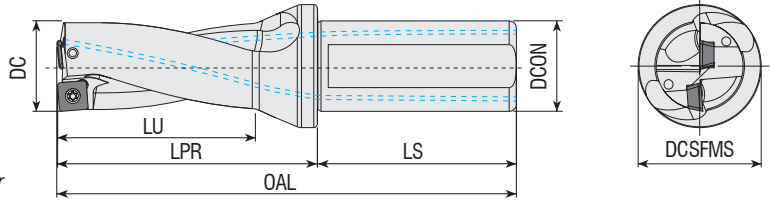

Takım Kodu Ordering Code Код для заказа	Stok Stock Наличие	Takım Ölçüleri (mm) Dimension (mm) Размеры (мм)								Maks. Ofset (radyal) Max. Offset (radial) Радиальное смещение		Kesici Uç Insert Пластина	Yedek Parçaları / Spare Parts / Запасные части	
		DC	DCON	DCSFMS	OAL	LU	LPR	LS	X _{max} X _{max} [mm]	DC _{max} DC _{max} [mm]	Sikma Vidası Screw Зажимной винт		Tork Anahtar Torx Key Торх Ключ	
ATUM 13XD4 SP. 050204	●	13	20	25	124	52	74	50	0.75	14.5	SP. 050204	3006-M2x4	82-T06	
ATUM 14XD4 SP. 050204	●	14	20	25	128	56	78	50	0.6	15.2				
new ATUM 14.5XD4 SP. 050204	●	14.5	20	25	128	56	78	50	0.60	15.7				
ATUM 15XD4 SP. 050204	●	15	20	25	132	60	82	50	0.5	16	SP. 060204	3007-M2.2x4.6	82-T07	
ATUM 16XD4 SP. 060204	●	16	25	34	142	64	86	56	0.8	17.6				
ATUM 17XD4 SP. 060204	●	17	25	34	146	68	90	56	0.75	18.5				
ATUM 17.5XD4 SP. 060204	●	17.5	25	34	146	68	90	56	0.75	19				
ATUM 18XD4 SP. 060204	●	18	25	34	150	72	94	56	0.5	19				
ATUM 19XD4 SP. 060204	●	19	25	34	154	76	98	56	0.3	19.6				
ATUM 19.5XD4 SP. 060204	●	19.5	25	34	154	76	98	56	0.3	20.1				
ATUM 20XD4 SP. 060204	●	20	25	34	158	80	102	56	0	20	SP. 07T308	3008-M2.5x6	82-T08	
ATUM 21XD4 SP. 060204	●	21	25	34	162	84	106	56	0	21				
ATUM 22XD4 SP. 07T308	●	22	25	34	166	88	110	56	1	24				
ATUM 23XD4 SP. 07T308	●	23	25	34	170	92	114	56	0.75	24.5				
ATUM 23.5XD4 SP. 07T308	●	23.5	25	34	170	92	114	56	0.75	25				
ATUM 24XD4 SP. 07T308	●	24	25	34	174	96	118	56	0.5	25				
ATUM 25XD4 SP. 07T308	●	25	25	34	178	100	122	56	0.25	25.5				
ATUM 26XD4 SP. 07T308	●	26	25	34	182	104	126	56	0	26	SP. 090408	4015-M3.5x9	80-T15	
ATUM 27XD4 SP. 07T308	●	27	25	34	186	108	130	56	0	27				
ATUM 27.5XD4 SP. 07T308	●	27.5	25	34	186	108	130	56	0	27.5				
ATUM 28XD4 SP. 090408	●	28	25	34	190	112	134	56	1	30				
ATUM 29XD4 SP. 090408	●	29	25	34	194	116	138	56	0.75	30.5				
ATUM 30XD4 SP. 090408	●	30	32	44	207	120	147	60	0.5	31				
ATUM 31XD4 SP. 090408	●	31	32	44	211	124	151	60	0.25	31.5				
ATUM 32XD4 SP. 090408	●	32	32	44	215	128	155	60	0	32	SP. 110408	4015-M4x11	80-T15	
ATUM 33XD4 SP. 090408	●	33	32	44	219	132	159	60	0	33				
ATUM 33.5XD4 SP. 090408	●	33.5	32	44	219	132	159	60	0	33.5				
ATUM 34XD4 SP. 110408	●	34	32	44	223	136	163	60	1	36				
ATUM 35XD4 SP. 110408	●	35	32	44	227	140	167	60	0.75	36.5				
ATUM 36XD4 SP. 110408	●	36	32	44	231	144	171	60	0.6	37.2				
ATUM 37XD4 SP. 110408	●	37	32	44	235	148	175	60	0.5	38				
ATUM 38XD4 SP. 110408	●	38	32	44	239	152	179	60	0.25	38.5	SP. 140512	1020-M5x11	80-T20	
ATUM 39XD4 SP. 110408	●	39	32	44	243	156	183	60	0	39				
ATUM 40XD4 SP. 110408	●	40	32	44	247	160	187	60	0	40				
ATUM 41XD4 SP. 110408	●	41	32	44	251	164	191	60	0	41	SP. 140512	1020-M5x11	80-T20	
ATUM 42XD4 SP. 140512	●	42	32	44	255	168	195	60	1.2	44.4				
ATUM 43XD4 SP. 140512	●	43	32	44	259	172	199	60	1	45				
ATUM 44XD4 SP. 140512	●	44	32	44	263	176	203	60	0.8	45.6				
new ATUM 46XD4 SP. 140512	●	46	40	54	286	184	216	70	0.40	46.8				

R: Sağ / Right / Правый L: Sol / Left / Левый
● Stokta / In Stock / В наличии ○ Stokta Yok / Non Stock Item / Нет в наличии
TGTC Ucuna Uygundur. / Compatible with TGTC Insert. / Под пластину TGTC.

Sipariş Örneği/Ordering Example/Образец заказа
1 ad./pcs./шт. ATUM 13XD4 SP. 050204
Takma Uçlu Matkap Kullanım Kılavuzu : S 375 / User's Guide For U-Drills : P 375
Руководство для эксплуатации сверл: стр. 375

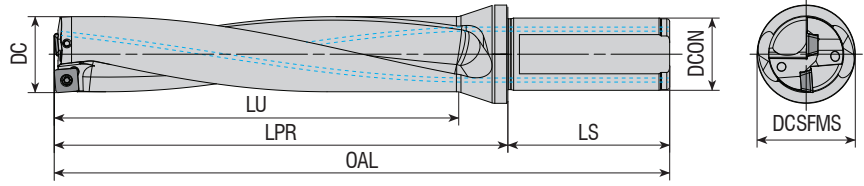

Delme Derinliği = 5x Çap
Drilling Depth = 5x Diameter
Глубина сверления = 5x Диаметр

Takım Kodu Ordering Code Код для заказа	Stok Stock Наличие	Takım Ölçüleri (mm) Dimension (mm) Размеры (мм)							Maks. Ofset (radyal) Max. Offset (radial) Радиальное смещение		Kesici Uç Insert Пластина	Yedek Parçaları / Spare Parts / Запасные части		
		DC	DCON	DCSFMS	OAL	LU	LPR	LS	X _{max} X _{max} [mm]	DC _{max} DC _{max} [mm]		Sıkma Vidası Screw Зажимной винт	Tork Anahtar Torx Key Торх Ключ	
new ATUM 13XD5 SP. 050204	●	13	20	25	137	65	87	50	0.75	14.5	SP. 050204	3006-M2.5x4 3006-M2x4 3006-M2.5x4	82-T06	
ATUM 14XD5 SP. 050204	●	14	20	25	142	70	92	50	0.6	15.2				
new ATUM 14.5XD5 SP. 050204	●	14.5	20	25	142	70	92	50	0.60	15.7				
new ATUM 15XD5 SP. 050204	●	15	20	25	147	75	97	50	0.50	16	SP. 060204	3007-M2.2x4.6 3007-M2.2x5	82-T07	
ATUM 16XD5 SP. 060204	●	16	25	34	158	80	102	56	0.8	17.6				
ATUM 17XD5 SP. 060204	●	17	25	34	163	85	107	56	0.75	18.5				
new ATUM 17XD5 SP. 060204-32	●	17	32	34	163	85	107	56	0.75	18.5	SP. 07T308	3008-M2.5x6	82-T08	
ATUM 18XD5 SP. 060204	●	18	25	34	168	90	112	56	0.5	19				
ATUM 19XD5 SP. 060204	●	19	25	34	173	95	117	56	0.3	19.6				
ATUM 20XD5 SP. 060204	●	20	25	34	178	100	122	56	0	20	SP. 090408	4015-M3.5x9	80-T15	
ATUM 21XD5 SP. 060204	●	21	25	34	183	105	127	56	0	21				
ATUM 22XD5 SP. 07T308	●	22	25	34	188	110	132	56	1	24				
ATUM 22XD5 SP. 07T308-32	●	22	32	44	197	110	137	60	1	24	SP. 090408	4015-M3.5x9	80-T15	
ATUM 23XD5 SP. 07T308	●	23	25	34	193	115	137	56	0.75	24.5				
ATUM 23XD5 SP. 07T308-32	●	23	32	44	202	115	142	60	0.75	24.5				
ATUM 24XD5 SP. 07T308-32	●	24	32	44	207	120	147	60	0.5	25	SP. 090408	4015-M3.5x9	80-T15	
ATUM 25XD5 SP. 07T308	●	25	25	34	203	125	147	56	0.25	25.5				
ATUM 25XD5 SP. 07T308-32	●	25	32	44	212	125	152	60	0.25	25.5				
ATUM 26XD5 SP. 07T308	●	26	25	34	208	130	152	56	0	26	SP. 090408	4015-M3.5x9	80-T15	
ATUM 26XD5 SP. 07T308-32	●	26	32	44	217	130	157	60	0	26				
ATUM 27XD5 SP. 07T308	●	27	25	34	213	135	157	56	0	27				
ATUM 27XD5 SP. 07T308-32	●	27	32	44	222	135	162	60	0	27	SP. 090408	4015-M3.5x9	80-T15	
ATUM 28XD5 SP. 090408-32	●	28	32	44	227	140	167	60	1	30				
ATUM 29XD5 SP. 090408-32	●	29	32	44	232	145	172	60	0.75	30.5				
ATUM 30XD5 SP. 090408	●	30	32	44	237	150	177	60	0.5	31	SP. 090408	4015-M3.5x9	80-T15	
ATUM 31XD5 SP. 090408	●	31	32	44	242	155	182	60	0.25	31.5				
ATUM 32XD5 SP. 090408	●	32	32	44	247	160	187	60	0	32				
ATUM 33XD5 SP. 090408	●	33	32	44	252	165	192	60	0	33				

R: Sağ / Right / Правый L: Sol / Left / Левый

● Stokta / In Stock / В наличии ○ Stokta Yok / Non Stock Item / Нет в наличии
TGTC Ucuna Uygundur. / Compatible with TGTC Insert. / Под пластину TGTC.

Sipariş Örneği/Ordering Example/Образец заказа

1 ad./pcs./шт. ATUM 13XD5 SP. 050204

Takma Uçlu Matkap Kullanım Kılavuzu : S 375 / User's Guide For U-Drills : P 375

Руководство для эксплуатации сверел: стр. 375



Delme Derinliği = 2x Çap
Drilling Depth = 2x Diameter
Глубина сверления = 2x Диаметр

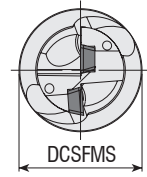
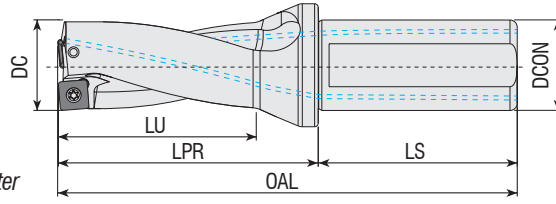

Takım Kodu
Ordering Code
Код для заказа

Stok
Stock
Наличие

Takım Ölçüleri (mm)
Dimension (mm)
Размеры (мм)

Maks. Ofset (radyal)
Max. Offset (radial)
Радиальное смещение

Kesici Uç
Insert
Пластина

Yedek Parçaları / Spare Parts / Запасные части

Sıkma Vidası
Screw
Зажимной винт

Tork Anahtar
Torx Key
Торх Ключ

DC DCON DCSFMS OAL LU LPR LS

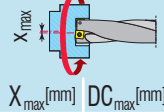

Takım Kodu Ordering Code Код для заказа	Stok Stock Наличие	Takım Ölçüleri (mm) Dimension (mm) Размеры (мм)							Maks. Ofset (radyal) Max. Offset (radial) Радиальное смещение		Kesici Uç Insert Пластина	Sıkma Vidası Screw Зажимной винт	Tork Anahtar Torx Key Торх Ключ
		DC	DCON	DCSFMS	OAL	LU	LPR	LS	X _{max}	DC _{max} [mm]			
ATUM 12.5XD2 SPGT 050204	●	12.5	20	25	96	24	46	50	0.75	14	SPGT 050204	3006-M2x4	82-T06
ATUM 13XD2 SPGT 050204	●	13	20	25	98	26	48	50	0.75	14.5			
ATUM 13.5XD2 SPGT 050204	●	13.5	20	25	98	26	48	50	0.75	15			
ATUM 14XD2 SPGT 050204	●	14	20	25	100	28	50	50	0.6	15.2			
ATUM 15XD2 SPGT 050204	●	15	20	25	102	30	52	50	0.5	16			
ATUM 16XD2 SPGT 060204	●	16	25	34	110	32	54	56	0.8	17.6	SPGT 060204	3007-M2.2x4.6	82-T07
ATUM 16.5XD2 SPGT 060204	●	16.5	25	34	110	32	54	56	0.8	18.1			
ATUM 17XD2 SPGT 060204	●	17	25	34	112	34	56	56	0.75	18.5			
ATUM 17.5XD2 SPGT 060204	●	17.5	25	34	112	34	56	56	0.75	19			
ATUM 18XD2 SPGT 060204	●	18	25	34	114	36	58	56	0.5	19			
ATUM 19XD2 SPGT 060204	●	19	25	34	116	38	60	56	0.3	19.6			
ATUM 20XD2 SPGT 060204	●	20	25	34	118	40	62	56	0	20			
new ATUM 21XD2 SPGT 060204	●	21	25	34	120	42	64	56	0	21			
ATUM 22XD2 SPGT 07T308	●	22	25	34	122	44	66	56	1	24	SPGT 07T308	3008-M2.5x6	82-T08
ATUM 22.5XD2 SPGT 07T308	●	22.5	25	34	122	44	66	56	1	24.5			
ATUM 23XD2 SPGT 07T308	●	23	25	34	124	46	68	56	0.75	24.5			
new ATUM 23.5XD2 SPGT 07T308	●	23.5	25	34	124	46	68	56	0.75	25			
ATUM 24XD2 SPGT 07T308	●	24	25	34	126	48	70	56	0.5	25			
new ATUM 24.5XD2 SPGT 07T308	●	24.5	25	34	126	48	70	56	0.5	25.5			
ATUM 25XD2 SPGT 07T308	●	25	25	34	128	50	72	56	0.25	25.5			
ATUM 26XD2 SPGT 07T308	●	26	25	34	130	52	74	56	0	26			
ATUM 28XD2 SPGT 090408	●	28	25	34	134	56	78	56	1	30	SPGT 090408	4015-M3.5x9	80-T15
ATUM 29XD2 SPGT 090408	●	29	25	34	136	58	80	56	0.75	30.5			
ATUM 30XD2 SPGT 090408	●	30	32	44	147	60	87	60	0.5	31			
new ATUM 31XD2 SPGT 090408	●	31	32	44	149	62	89	60	0.25	31.5			
ATUM 32XD2 SPGT 090408	●	32	32	44	151	64	91	60	0	32			
ATUM 35XD2 SPGT 110408	●	35	32	44	157	70	97	60	0.75	36.5	SPGT 110408	4015-M4x11	80-T15
ATUM 36XD2 SPGT 110408	●	36	32	44	159	72	99	60	0.6	37.2			
ATUM 40XD2 SPGT 110408	●	40	32	44	167	80	107	60	0	40			

R: Sağ / Right / Правый L: Sol / Left / Левый
● Stokta / In Stock / В наличии ○ Stokta Yok / Non Stock Item / Нет в наличии
ZCC Ucuna Uygunudur. / Compatible with ZCC Insert. / Под пластину ZCC.

Sipariş Örneği/Ordering Example/Образец заказа
1 ad./pcs./шт. ATUM 12.5XD2 SPGT 050204

Takma Uçlu Matkap Kullanım Kılavuzu : S 375 / User's Guide For U-Drills : P 375
Руководство для эксплуатации сверел: стр. 375





Delme Derinliği = 3x Çap
Drilling Depth = 3x Diameter
Глубина сверления = 3x Диаметр

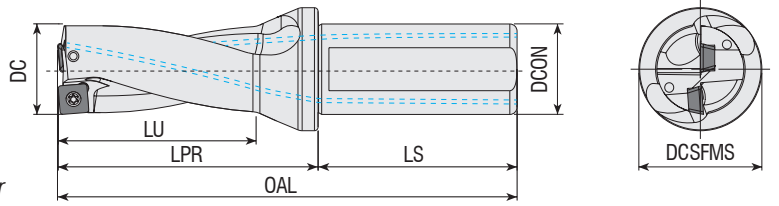

Takım Kodu
Ordering Code
Код для заказа

Stok Stock Наличие	Takım Ölçüleri (mm) Dimension (mm) Размеры (мм)								Maks. Ofset (radyal) Max. Offset (radial) Радиальное смещение		Kesici Uç Insert Пластина	Yedek Parçaları / Spare Parts / Запасные части		
	DC	DCON	DCSFMS	OAL	LU	LPR	LS	X _{max}	DC _{max}	Sıkma Vidası Screw Зажимной винт		Tork Anahtar Torx Key Торх Ключ		
ATUM 12.5XD3 SPGT 050204	●	12.5	20	25	108	36	58	50	0.75	14	SPGT 050204	3006-M2x4	82-T06	
ATUM 13XD3 SPGT 050204	●	13	20	25	111	39	61	50	0.75	14.5				
ATUM 13.5XD3 SPGT 050204	●	13.5	20	25	111	39	61	50	0.75	15				
ATUM 14XD3 SPGT 050204	●	14	20	25	114	42	64	50	0.6	15.2				
ATUM 14.5XD3 SPGT 050204	●	14.5	20	25	114	42	64	50	0.6	15.7				
ATUM 15XD3 SPGT 050204	●	15	20	25	117	45	67	50	0.5	16				
ATUM 15.5XD3 SPGT 060204	●	15.5	20	25	117	45	67	50	0.9	17.3	SPGT 060204	3007-M2.2x4.6	82-T07	
ATUM 16XD3 SPGT 060204	●	16	25	34	126	48	70	56	0.8	17.6				
ATUM 16.5XD3 SPGT 060204	●	16.5	25	34	126	48	70	56	0.8	18.1				
ATUM 17XD3 SPGT 060204	●	17	25	34	129	51	73	56	0.75	18.5				
ATUM 17.5XD3 SPGT 060204	●	17.5	25	34	129	51	73	56	0.75	19				
ATUM 18XD3 SPGT 060204	●	18	25	34	132	54	76	56	0.5	19				
ATUM 18.5XD3 SPGT 060204	●	18.5	25	34	132	54	76	56	0.5	19.5				
ATUM 19XD3 SPGT 060204	●	19	25	34	135	57	79	56	0.3	19.6				
ATUM 19.5XD3 SPGT 060204	●	19.5	25	34	135	57	79	56	0.3	20.1				
ATUM 20XD3 SPGT 060204	●	20	25	34	138	60	82	56	0	20				
ATUM 20.5XD3 SPGT 060204	●	20.5	25	34	138	60	82	56	0	20.5				
ATUM 21XD3 SPGT 060204	●	21	25	34	141	63	85	56	0	21				
ATUM 21.5XD3 SPGT 060204	●	21.5	25	34	141	63	85	56	0	21.5				
ATUM 22XD3 SPGT 07T308	●	22	25	34	144	66	88	56	1	24	SPGT 07T308	3008-M2.5x6	82-T08	
ATUM 22.5XD3 SPGT 07T308	●	22.5	25	34	144	66	88	56	1	24.5				
ATUM 23XD3 SPGT 07T308	●	23	25	34	147	69	91	56	0.75	24.5				
ATUM 23.5XD3 SPGT 07T308	●	23.5	25	34	147	69	91	56	0.75	25				
ATUM 24XD3 SPGT 07T308	●	24	25	34	150	72	94	56	0.5	25				
ATUM 24.5XD3 SPGT 07T308	●	24.5	25	34	150	72	94	56	0.5	25.5				
ATUM 25XD3 SPGT 07T308	●	25	25	34	153	75	97	56	0.25	25.5				
ATUM 25.5XD3 SPGT 07T308	●	25.5	25	34	153	75	97	56	0.25	26				
ATUM 26XD3 SPGT 07T308	●	26	25	34	156	78	100	56	0	26				
ATUM 26.5XD3 SPGT 07T308	●	26.5	25	34	156	78	100	56	0	26.5				
ATUM 27XD3 SPGT 07T308	●	27	25	34	159	81	103	56	0	27				
ATUM 27.5XD3 SPGT 07T308	●	27.5	25	34	159	81	103	56	0	27.5				
ATUM 28XD3 SPGT 090408	●	28	25	34	162	84	106	56	1	30	SPGT 090408	4015-M3.5x9	80-T15	
ATUM 28.5XD3 SPGT 090408	●	28.5	25	34	162	84	106	56	1	30.5				
ATUM 29XD3 SPGT 090408	●	29	25	34	165	87	109	56	0.75	30.5				
ATUM 29.5XD3 SPGT 090408	●	29.5	25	34	165	87	109	56	0.75	31				
ATUM 30XD3 SPGT 090408	●	30	32	44	177	90	117	60	0.5	31				
ATUM 31XD3 SPGT 090408	●	31	32	44	180	93	120	60	0.25	31.5				
ATUM 32XD3 SPGT 090408	●	32	32	44	183	96	123	60	0	32				
ATUM 33XD3 SPGT 090408	●	33	32	44	186	99	126	60	0	33				

R: Sağ / Right / Правый L: Sol / Left / Левый

● Stokta / In Stock / В наличии ○ Stokta Yok / Non Stock Item / Нет в наличии
ZCC Ucuna Uygundur. / Compatible with ZCC Insert. / Под пластину ZCC.



www.akkо.com.tr

Sipariş Örneği/Ordering Example/Образец заказа
1 ad./pcs./шт. ATUM 12.5XD3 SPGT 050204

Takma Uçlu Matkap Kullanım Kılavuzu : S 375 / User's Guide For U-Drills : P 375
Руководство для эксплуатации сверел: стр. 375



Delme Derinliği = 3x Çap
Drilling Depth = 3x Diameter
Глубина сверления = 3x Диаметр

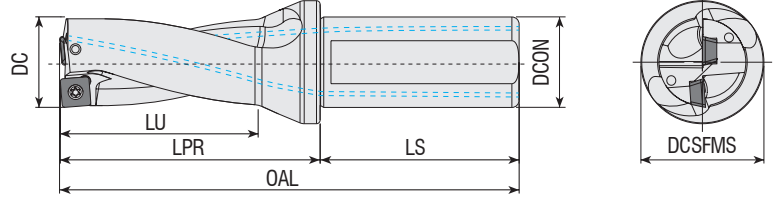

Takım Kodu
Ordering Code
Код для заказа

Stok Stock Наличие	Takım Ölçüleri (mm) Dimension (mm) Размеры (мм)								Maks. Ofset (radyal) Max. Offset (radial) Радиальное смещение		Kesici Uç Insert Пластина	Yedek Parçaları / Spare Parts / Запасные части		
	DC	DCON	DCSFMS	OAL	LU	LPR	LS	X _{max}	DC _{max}	Sıkma Vidası Screw Зажимной винт		Tork Anahtar Torx Key Торх Ключ		
●	34	32	44	189	102	129	60	1	36	SPGT 110408	4015-M4x11	80-T15		
●	35	32	44	192	105	132	60	0.75	36.5					
●	36	32	44	195	108	135	60	2.5	41					
●	36.5	32	44	195	110	135	60	0.6	37.7					
●	37	32	44	198	111	138	60	0.5	38					
●	38	32	44	201	114	141	60	0.25	38.5					
●	39	32	44	204	117	144	60	0	39					
●	40	32	44	207	120	147	60	0	40					
●	42	32	44	213	126	153	60	1.2	44.4	SPGT 140512	1020-M5x11	80-T20		
●	43	32	44	216	129	156	60	1	45					
●	44	32	44	219	132	159	60	0.8	45.6					
●	49	40	54	249	147	179	70	0	49					
●	49	40	54	249	147	179	70	0	49					
●	50	40	54	252	150	182	70	0	50					

R: Sağ / Right / Правый L: Sol / Left / Левый

● Stokta / In Stock / В наличии ○ Stokta Yok / Non Stock Item / Нет в наличии
ZCC Ucuna Uygun. / Compatible with ZCC Insert. / Под пластину ZCC.

Sipariş Örneği/Ordering Example/Образец заказа

1 ad./pcs./шт. ATUM 34XD3 SPGT 110408

Takma Uçlu Matkap Kullanım Kılavuzu : S 375 / User's Guide For U-Drills : P 375

Руководство для эксплуатации сверел: стр. 375





Delme Derinliği = 4x Çap
Drilling Depth = 4x Diameter
Глубина сверления = 4x Диаметр

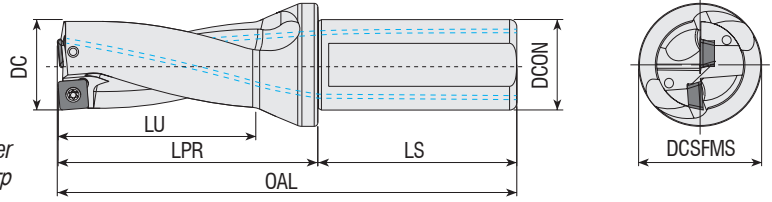

Takım Kodu
Ordering Code
Код для заказа

Stok Stock Наличие	Takım Ölçüleri (mm) Dimension (mm) Размеры (мм)								Maks. Ofset (radyal) Max. Offset (radial) Радиальное смещение		Kesici Uç Insert Пластина	Yedek Parçaları / Spare Parts / Запасные части	
	DC	DCON	DCSFMS	OAL	LU	LPR	LS	X _{max} X _{max} [mm]	DC _{max} DC _{max} [mm]	Sıkma Vidası Screw Зажимной винт		Tork Anahtar Torx Key Торх Ключ	
●	13	20	25	124	52	74	50	0.75	14.5	SPGT 050204	3006-M2x4	82-T06	
●	14	20	25	128	56	78	50	0.6	15.2				
●	14.5	20	25	128	58	78	50	0.6	15.7				
●	15	20	25	132	60	82	50	0.5	16				
●	16	25	34	142	64	86	56	0.8	17.6	SPGT 060204	3007-M2.2x5	82-T07	
●	17	25	34	146	68	90	56	0.75	18.5				
●	17.5	25	34	146	68	90	56	0.75	19				
●	18	25	34	150	72	94	56	0.5	19				
●	19	25	34	154	76	98	56	0.3	19.6	SPGT 07T308	3008-M2.5x6	82-T08	
●	19.5	25	34	154	76	98	56	0.3	20.1				
●	20	25	34	158	80	102	56	0	20				
●	21	25	34	162	84	106	56	0	21				
●	22	25	34	166	88	110	56	1	24	SPGT 090408	4015-M3.5x9	80-T15	
●	23	25	34	170	92	114	56	0.75	24.5				
●	23.5	25	34	170	92	114	56	0.75	25				
●	24	25	34	174	96	118	56	0.5	25				
●	25	25	34	178	100	122	56	0.25	25.5	SPGT 110408	4015-M4x11	80-T15	
●	26	25	34	182	104	126	56	0	26				
●	27.5	25	34	186	108	130	56	0	27.5				
●	28	25	34	190	112	134	56	1	30				
●	29	25	34	194	116	138	56	0.75	30.5	SPGT 090408	4015-M3.5x9	80-T15	
●	29	25	34	194	116	138	56	0.75	30.5				
●	30	32	44	207	120	147	60	0.5	31				
●	31	32	44	211	124	151	60	0.75	32.5				
●	32	32	44	215	128	155	60	0	32	SPGT 110408	4015-M4x11	80-T15	
●	32	32	44	215	128	155	60	0	32				
●	33.5	32	44	219	132	159	60	0	33.5	SPGT 110408	4015-M4x11	80-T15	
●	38	32	44	239	152	179	60	0.25	38.5				

ZCC Ucuna Uygun. / Compatible with ZCC Insert. / Под пластину ZCC.

Takma Uçlu Matkap Kullanım Kılavuzu : S 375 / User's Guide For U-Drills : P 375
Руководство для эксплуатации сверел: стр. 375

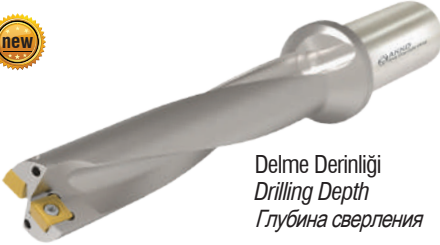

Delme Derinliği = 5x Çap
Drilling Depth = 5x Diameter
Глубина сверления = 5x Диаметр

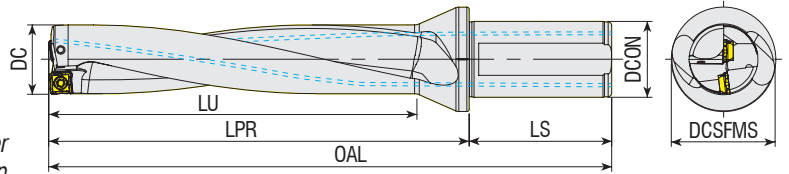

Takım Kodu
Ordering Code
Код для заказа

Stok Stock Наличие	Takım Ölçüleri (mm) Dimension (mm) Размеры (мм)								Maks. Ofset (radyal) Max. Offset (radial) Радиальное смещение		Kesici Uç Insert Пластина	Yedek Parçaları / Spare Parts / Запасные части	
	DC	DCON	DCSFMS	OAL	LU	LPR	LS	X _{max} X _{max} [mm]	DC _{max} DC _{max} [mm]	Sıkma Vidası Screw Зажимной винт		Tork Anahtar Torx Key Торх Ключ	
●	22	25	34	188	110	132	56	1	24	SPGT 07T308	3008-M2.5x6	82-T08	
●	26	32	44	217	130	157	60	0	26				

R: Sağ / Right / Правый L: Sol / Left / Левый

● Stokta / In Stock / В наличии ○ Stokta Yok / Non Stock Item / Нет в наличии

ZCC Ucuna Uygun. / Compatible with ZCC Insert. / Под пластину ZCC.

Sipariş Örneği/Ordering Example/Образец заказа

1 ad./pcs./шт. ATUM 13XD4 SPGT 050204

Takma Uçlu Matkap Kullanım Kılavuzu : S 375 / User's Guide For U-Drills : P 375

Руководство для эксплуатации сверел: стр. 375



Delme Derinliği = 3x Çap
Drilling Depth = 3x Diameter
Глубина сверления = 3x Диаметр

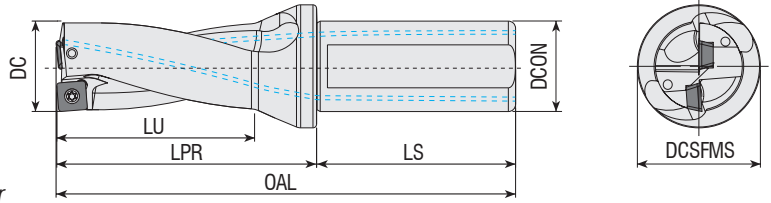

Takım Kodu
Ordering Code
Код для заказа

Stok
Stock
Наличие

Takım Ölçüleri (mm)
Dimension (mm)
Размеры (мм)

Maks. Ofset (radyal)
Max. Offset (radial)
Радиальное смещение

Kesici Uç
Insert
Пластина

Yedek Parçaları / Spare Parts / Запасные части

Sıkma Vidası
Screw
Зажимной винт

Tork Anahtar
Torx Key
Торх Ключ

Takım Kodu Ordering Code Код для заказа	Stok Stock Наличие	Takım Ölçüleri (mm) Dimension (mm) Размеры (мм)							Maks. Ofset (radyal) Max. Offset (radial) Радиальное смещение		Kesici Uç Insert Пластина	Sıkma Vidası Screw Зажимной винт	Tork Anahtar Torx Key Торх Ключ
		DC	DCON	DCSFMS	OAL	LU	LPR	LS	X _{max} [mm]	DC _{max} [mm]			
ATUM 14XD3 SO.. 050204	●	14	20	25	114	42	64	50	1.4	16.8	SO.. 050204	3006-M2x4	82-T06
ATUM 15XD3 SO.. 050204	●	15	20	25	117	45	67	50	1.2	17.4			
ATUM 16XD3 SO.. 050204	●	16	25	34	126	48	70	56	0.9	17.8			
ATUM 16.5XD3 SO.. 050204	●	16.5	25	34	126	48	70	56	0.8	18.1			
ATUM 17XD3 SO.. 050204	●	17	25	34	129	51	73	56	0.65	18.3			
ATUM 17.5XD3 SO.. 050204	●	17.5	25	34	129	51	73	56	0.5	18.5	SO.. 060304	3007-M2.2x4.6	82-T07
ATUM 18XD3 SO.. 060304	●	18	25	34	132	54	76	56	1.15	20.3			
ATUM 19XD3 SO.. 060304	●	19	25	34	135	57	79	56	0.9	20.8			
ATUM 20XD3 SO.. 060304	●	20	25	34	138	60	82	56	0.65	21.3			
ATUM 21XD3 SO.. 070305	●	21	25	34	141	63	85	56	1.75	24.5			
ATUM 22XD3 SO.. 070305	●	22	25	34	144	66	88	56	1.5	25			
ATUM 22.5XD3 SO.. 070305	●	22.5	25	34	144	66	88	56	1.35	25.2			
ATUM 23XD3 SO.. 070305	●	23	25	34	147	69	91	56	1.25	25.5			
ATUM 24XD3 SO.. 070305	●	24	25	34	150	72	94	56	1	26	SO.. 09T306	4010-M3x8	82-T10
ATUM 25XD3 SO.. 09T306	●	25	25	34	153	75	97	56	2.25	29.5			
ATUM 26XD3 SO.. 09T306	●	26	25	34	156	78	100	56	2	30			
ATUM 27XD3 SO.. 09T306	●	27	25	34	159	81	103	56	1.75	30.5			
ATUM 29XD3 SO.. 09T306	●	29	25	34	174	87	114	56	1.25	31.5			
ATUM 30XD3 SO.. 09T306	●	30	32	44	177	90	117	60	1	32			
ATUM 31XD3 SO.. 09T306	●	31	32	44	200	93	120	60	0.75	32.5			
ATUM 33XD3 SO.. 09T306	●	33	32	44	186	99	126	60	0.5	34			
ATUM 35XD3 SO.. 120408	●	35	32	44	192	105	132	60	2.75	40.5			
ATUM 36XD3 SO.. 120408	●	36	32	44	195	108	135	60	2.5	41			
ATUM 37XD3 SO.. 120408	●	37	32	44	198	111	138	60	2.25	41.5			
ATUM 38XD3 SO.. 120408	●	38	32	44	201	114	141	60	1.75	41.5			
ATUM 39XD3 SO.. 120408	●	39	32	44	204	117	144	60	1.75	42.5			
ATUM 40XD3 SO.. 120408	●	40	32	44	207	120	147	60	1.5	43			
ATUM 43XD3 SO.. 120408	●	43	32	44	216	129	156	60	0.75	44.5			

R: Sağ / Right / Правый L: Sol / Left / Левый
● Stokta / In Stock / В наличии ○ Stokta Yok / Non Stock Item / Нет в наличии
ISCR Ucuna Uygundur. / Compatible with ISCR Insert. / Под пластину ISCR

Sipariş Örneği/Ordering Example/Образец заказа
1 ad./pcs./шт. ATUM 14XD3 SO.. 050204
Takma Uçlu Matkap Kullanım Kılavuzu : S 375 / User's Guide For U-Drills : P 375
Руководство для эксплуатации сверел: стр. 375



Delme Derinliği = 4x Çap
Drilling Depth = 4x Diameter
Глубина сверления = 4x Диаметр

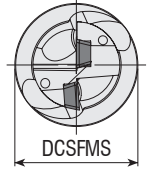
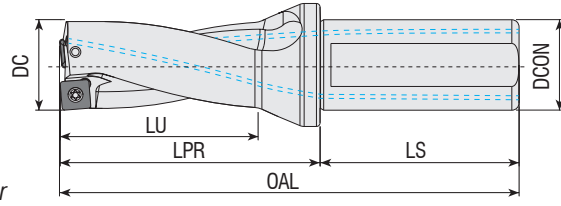

Takım Kodu Ordering Code Код для заказа	Stok Stock Наличие	Takım Ölçüleri (mm) Dimension (mm) Размеры (мм)							Maks. Ofset (radyal) Max. Offset (radial) Радиальное смещение	Kesici Uç Insert Пластина	Yedek Parçaları / Spare Parts / Запасные части		
		DC	DCON	DCSFMS	OAL	LU	LPR	LS			Sıkma Vidası Screw Зажимной винт	Tork Anahtar Torx Key Торх Ключ	
ATUM 14XD4 SO.. 050204	●	14	20	25	128	56	78	50	1.4	16.8	SO.. 050204	3006-M2x4	82-T06
ATUM 14.5XD4 SO.. 050204	●	14.5	20	25	128	56	78	50	1.3	17.1			
ATUM 15XD4 SO.. 050204	●	15	20	25	132	60	62	50	1.2	17.4			
ATUM 15.5XD4 SO.. 050204	●	15.5	20	25	132	60	82	50	1	17.5			
ATUM 17XD4 SO.. 050204	●	17	25	34	146	68	90	56	0.65	18.3			
ATUM 19XD4 SO.. 060304	●	19	25	34	154	76	98	56	0.9	20.8	SO.. 060304	3007-M2.2x4.6	82-T07
ATUM 19.5XD4 SO.. 060304	●	19.5	25	34	154	76	98	56	0.75	21			
ATUM 20XD4 SO.. 060304	●	20	25	34	158	80	102	56	0.65	21.3			
ATUM 21XD4 SO.. 070305	●	21	25	34	162	84	106	56	1.75	24.5	SO.. 070305	3008-M2.5x6	82-T08
ATUM 22XD4 SO.. 070305	●	22	25	34	166	88	110	56	1.5	25			
ATUM 22.5XD4 SO.. 070305	●	22.5	25	34	166	88	110	56	1.35	25.2			
ATUM 23XD4 SO.. 070305	●	23	25	34	170	92	114	56	1.25	25.5			
ATUM 24XD4 SO.. 070305	●	24	25	34	174	96	118	56	1	26			
ATUM 25XD4 SO.. 09T306	●	25	25	34	178	100	122	56	2.25	29.5	SO.. 09T306	4010-M3x8	82-T10
ATUM 27XD4 SO.. 09T306	●	27	25	34	186	108	130	56	1.75	30.5			
ATUM 28XD4 SO.. 09T306	●	28	25	34	190	112	134	56	1.5	31			
ATUM 29XD4 SO.. 09T306	●	29	25	34	194	116	138	56	1.25	31.5			
ATUM 30XD4 SO.. 09T306	●	30	32	44	207	120	147	60	1	32			
ATUM 31XD4 SO.. 09T306	●	31	32	44	211	124	151	60	0.75	32.5	SO..120408	4015-M4X11	80-T15
ATUM 33XD4 SO.. 09T306	●	33	32	44	219	132	159	60	0.5	34			
ATUM 34XD4 SO.. 09T306	●	34	32	44	223	136	163	60	0.25	34.5			
ATUM 35XD4 SO.. 120408	●	35	32	44	227	140	167	60	2.75	40.5			

R: Sağ / Right / Правый L: Sol / Left / Левый

● Stokta / In Stock / В наличии ○ Stokta Yok / Non Stock Item / Нет в наличии
ISCR Ucuna Uygundur. / Compatible with ISCR Insert. / Под пластину ISCR

Sipariş Örneği/Ordering Example/Образец заказа

1 ad./pcs./шт. ATUM 14XD4 SO.. 050204

Takma Uçlu Matkap Kullanım Kılavuzu : S 375 / User's Guide For U-Drills : P 375

Руководство для эксплуатации сверел : стр. 375



Delme Derinliği = 2x Çap
Drilling Depth = 2x Diameter
Глубина сверления = 2x Диаметр

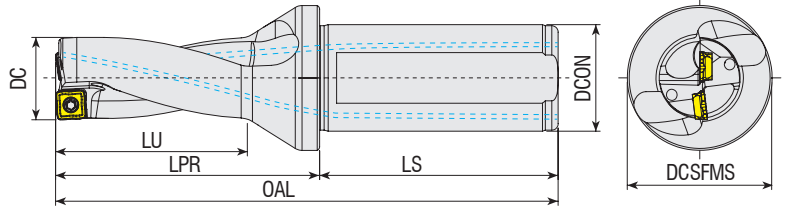

Takım Kodu
Ordering Code
Код для заказа

Stok Stock Наличие	Takım Ölçüleri (mm) Dimension (mm) Размеры (мм)								Maks. Ofset (radyal) Max. Offset (radial) Радиальное смещение		Kesici Uç Insert Пластина	Yedek Parçaları / Spare Parts / Запасные части	
	DC	DCON	DCSFMS	OAL	LU	LPR	LS	X _{max} X _{max} [mm]	DC _{max} DC _{max} [mm]	Sıkma Vidası Screw Зажимной винт		Tork Anahtar Torx Key Торх Ключ	
●	14	20	25	100	28	50	50	0.60	15.20	SOMX 052704	3006-M2x4.7	82-T08	
●	15	20	25	102	30	52	50	0.35	15.70				
●	16	25	34	110	32	54	56	0.25	16.50				
●	17	25	34	112	34	56	56	0.50	18.00	SOMX 063005	3008-M2.5X6	82-T10	
●	18	25	34	114	36	58	56	0.40	18.80				
●	19	25	34	116	38	60	56	0.30	19.60				
●	20	25	34	118	40	62	56	0.60	21.20	SOMX 073505	4010-M3X6	82-T10	
●	21	25	34	120	42	64	56	0.50	22.00				
●	22	25	34	122	44	66	56	0.40	22.80				
●	23	25	34	124	46	68	56	0.80	24.60	SOMX 084005	3010-M3.5X7	80-T15	
●	24	25	34	126	48	70	56	0.70	25.40				
●	25	25	34	128	50	72	56	0.60	26.20				
●	26	25	34	130	52	74	56	0.50	27.00	SOMX 094506	4015-M4X8	80-T15	
●	28	25	34	134	56	78	56	0.85	29.70				
●	30	32	44	147	60	87	60	0.65	31.30				

R: Sağ / Right / Правый L: Sol / Left / Левый
● Stokta / In Stock / В наличии ○ Stokta Yok / Non Stock Item / Нет в наличии
MTSBH Ucuna Uygunudur. / Compatible with MTSBH Insert. / Под пластину MTSBH.

Sipariş Örneği/Ordering Example/Образец заказа
1 ad./pcs./шт. ATUM 14XD2 SO.. 052704
Takma Uçlu Matkap Kullanım Kılavuzu : S 375 / User's Guide For U-Drills : P 375
Руководство для эксплуатации сверел: стр. 375





Delme Derinliği = 3x Çap
Drilling Depth = 3x Diameter
Глубина сверления = 3x Диаметр

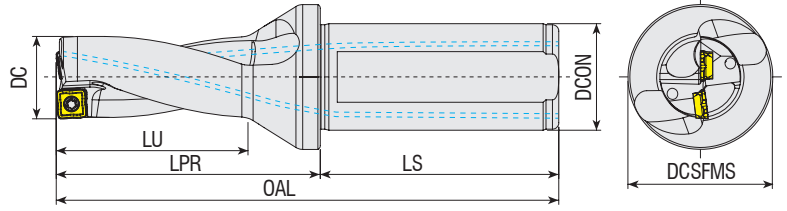

Takım Kodu Ordering Code Код для заказа	Stok Stock Наличие	Takım Ölçüleri (mm) Dimension (mm) Размеры (мм)							Maks. Ofset (radyal) Max. Offset (radial) Радиальное смещение	Kesici Uç Insert Пластина	Yedek Parçaları / Spare Parts / Запасные части		
		DC	DCON	DCSFMS	OAL	LU	LPR	LS			Sıkma Vidası Screw Зажимной винт	Tork Anahtar Torx Key Торх Ключ	
ATUM 14XD3 SO.. 052704	●	14	20	25	114	42	64	50	0.60	15.2	SOMX 052704	3006-M2x4.7	82-T08
ATUM 14.5XD3 SO.. 052704	●	14.5	20	25	114	43.5	64	50	0.50	15.5			
ATUM 15XD3 SO.. 052704	●	15	20	25	117	45	67	50	0.35	15.7			
ATUM 15.5XD3 SO.. 052704	●	16.5	25	34	126	49.5	70	56	0.25	17.0			
ATUM 16XD3 SO.. 052704	●	16	25	34	126	48	70	56	0.25	16.5			
ATUM 16.5XD3 SO.. 052704	●	16.5	25	34	126	49.5	70	56	0.25	17.0			
ATUM 17XD3 SO.. 063005	●	17	25	34	129	51	73	56	0.50	18.0	SOMX 063005	3008-M2.5X6	82-T08
ATUM 17.5XD3 SO.. 063005	●	17.5	25	34	129	52.5	73	56	0.45	18.4			
ATUM 18XD3 SO.. 063005	●	18	25	34	132	54	76	56	0.40	18.8			
ATUM 18.5XD3 SO.. 063005	●	18.5	25	34	132	55.5	76	56	0.35	19.2			
ATUM 19XD3 SO.. 063005	●	19	25	34	135	57	79	56	0.30	19.6			
ATUM 19.5XD3 SO.. 063005	●	19.5	25	34	135	58.5	79	56	0.25	20.0			
ATUM 20XD3 SO.. 073505	●	20	25	34	138	60	82	56	0.60	21.2	SOMX 073505	4010-M3X6	82-T10
ATUM 20.5XD3 SO.. 073505	●	20.5	25	34	138	61.5	82	56	0.55	21.6			
ATUM 21XD3 SO.. 073505	●	21	25	34	141	63	85	56	0.50	22.0			
ATUM 21.5XD3 SO.. 073505	●	21.5	25	34	141	64.5	85	56	0.45	22.4			
ATUM 22XD3 SO.. 073505	●	22	25	34	144	66	88	56	0.40	22.8			
ATUM 22.5XD3 SO.. 073505	●	22.5	25	34	144	67.5	88	56	0.35	23.2			
ATUM 23XD3 SO.. 084005	●	23	25	34	147	69	91	56	0.80	24.6	SOMX 084005	3010-M3.5X7	82-T10
ATUM 23.5XD3 SO.. 084005	●	23.5	25	34	147	70.5	91	56	0.75	25.0			
ATUM 24XD3 SO.. 084005	●	24	25	34	150	72	94	56	0.70	25.4			
ATUM 24.5XD3 SO.. 084005	●	24.5	25	34	150	73.5	94	56	0.65	25.8			
ATUM 25XD3 SO.. 084005	●	25	25	34	153	75	97	56	0.60	26.2			
ATUM 26XD3 SO.. 084005	●	26	25	34	156	78	100	56	0.50	27			
ATUM 27XD3 SO.. 084005	●	27	25	34	159	81	103	56	0.45	27.9	SOMX 094506	4015-M4X8	80-T15
ATUM 28XD3 SO.. 094506	●	28	25	34	162	84	106	56	0.85	29.7			
ATUM 29XD3 SO.. 094506	●	29	25	34	165	87	109	56	0.75	30.5			
ATUM 30XD3 SO.. 094506	●	30	32	44	177	90	117	60	0.65	31.3			
ATUM 32XD3 SO.. 094506	●	32	32	44	183	96	123	60	0.45	32.9			

R: Sağ / Right / Правый L: Sol / Left / Левый

● Stokta / In Stock / В наличии ○ Stokta Yok / Non Stock Item / Нет в наличии

MTSBH Ucuna Uygun. / Compatible with MTSBH Insert. / Под пластину MTSBH.

Sipariş Örneği/Ordering Example/Образец заказа

1 ad./pcs./шт. ATUM 14XD3 SO.. 052704

Takma Uçlu Matkap Kullanım Kılavuzu : S 375 / User's Guide For U-Drills : P 375

Руководство для эксплуатации сверел: стр. 375



Delme Derinliği = 4x Çap
Drilling Depth = 4x Diameter
Глубина сверления = 4x Диаметр

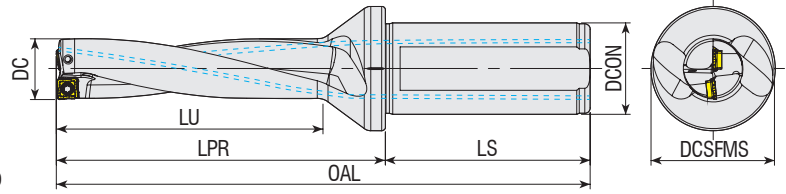

Takım Kodu
Ordering Code
Код для заказа

Takım Kodu Ordering Code Код для заказа	Stok Stock Наличие	Takım Ölçüleri (mm) Dimension (mm) Размеры (мм)							Maks. Ofset (radyal) Max. Offset (radial) Радиальное смещение		Kesici Uç Insert Пластина	Yedek Parçaları / Spare Parts / Запасные части	
		DC	DCON	DCSFMS	OAL	LU	LPR	LS	X _{max} X _{max} [mm]	DC _{max} DC _{max} [mm]		Sıkma Vidası Screw Зажимной винт	Tork Anahtar Torx Key Торх Ключ
ATUM 14XD4 SO.. 052704	●	14	20	25	128	56	78	50	0.60	15.2	SOMX 052704	3006-M2x4.7	82-T08
ATUM 15XD4 SO.. 052704	●	15	20	25	132	60	82	50	0.35	15.7			
ATUM 16XD4 SO.. 052704	●	16	25	34	142	64	86	56	0.25	16.5	SOMX 063005	3008-M2.5X6	82-T08
ATUM 17XD4 SO.. 063005	●	17	25	34	146	68	90	56	0.50	18.0			
ATUM 18XD4 SO.. 063005	●	18	25	34	150	72	94	56	0.40	18.8	SOMX 073505	4010-M3X6	82-T10
ATUM 19XD4 SO.. 063005	●	19	25	34	154	76	98	56	0.30	19.6			
ATUM 20XD4 SO.. 073505	●	20	25	34	158	80	102	56	0.60	21.2	SOMX 084005	3010-M3.5X7	80-T15
ATUM 21XD4 SO.. 073505	●	21	25	34	162	84	106	56	0.50	22.0			
ATUM 22XD4 SO.. 073505	●	22	25	34	166	88	110	56	0.40	22.8	SOMX 094506	4015-M4X8	80-T15
ATUM 23XD4 SO.. 084005	●	23	25	34	170	92	114	56	0.80	24.6			
ATUM 24XD4 SO.. 084005	●	24	25	34	174	96	118	56	0.70	25.4	SOMX 094506	4015-M4X8	80-T15
ATUM 25XD4 SO.. 084005	●	25	25	34	178	100	122	56	0.60	26.2			
ATUM 26XD4 SO.. 084005	●	26	25	34	182	104	126	56	0.50	27.0	SOMX 094506	4015-M4X8	80-T15
ATUM 28XD4 SO.. 094506	●	28	25	34	190	112	134	56	0.85	29.7			
ATUM 30XD4 SO.. 094506	●	30	32	44	207	120	147	60	0.65	31.3	SOMX 094506	4015-M4X8	80-T15
ATUM 30XD4 SO.. 094506	●	30	32	44	207	120	147	60	0.65	31.3			

R: Sağ / Right / Правый L: Sol / Left / Левый
● Stokta / In Stock / В наличии ○ Stokta Yok / Non Stock Item / Нет в наличии
MTSBH Ucuna Uygunudur. / Compatible with MTSBH Insert. / Под пластину MTSBH.

Sipariş Örneği/Ordering Example/Образец заказа
1 ad./pcs./шт. ATUM 14XD4 SO.. 052704

Takma Uçlu Matkap Kullanım Kılavuzu : S 375 / User's Guide For U-Drills : P 375
Руководство для эксплуатации сверел: стр. 375





Delme Derinliği = 2x Çap
Drilling Depth = 2x Diameter
Глубина сверления = 2x Диаметр

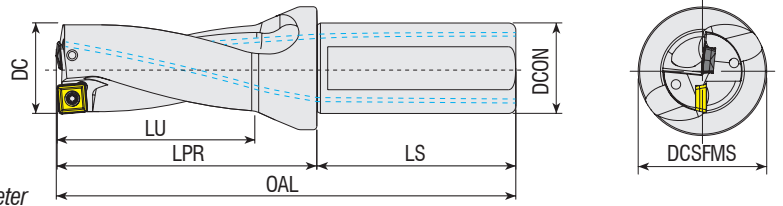

Takım Kodu
Ordering Code
Код для заказа

Stok Stock Наличие	Takım Ölçüleri (mm) Dimension (mm) Размеры (мм)								Maks. Ofset (radyal) Max. Offset (radial) Радиальное смещение		Kesici Uç Insert Пластина	Yedek Parçaları / Spare Parts / Запасные части	
	DC	DCON	DCSFMS	OAL	LU	LPR	LS	X _{max}	DC _{max}	Sıkma Vidası Screw Зажимной винт		Tork Anahtar Torx Key Торх Ключ	
●	14	20	25	100	28	50	50	0.25	14.5	SPMT 050204-XOMT 050204	3006-M2x4	82-T06	
●	18	25	34	114	36	58	56	0.5	19	SPMT 060205-XOMT 060204	3007-M2.2x4.6	82-T07	
●	20	25	34	118	40	62	56	0.3	20.6	SPMT 07T208 XOMT 07T205	3008-M2.5x6	82-T08	
●	22	25	34	122	44	66	56	0.3	22.6	SPMT 090308 XOMT 090305	3008-M3x7		
●	24	25	34	126	48	70	56	0.3	24.6			SPMT 11T308 XOMT 11T306	4015-M3.5x9
●	25	25	34	128	50	72	56	0.3	25.6				
●	26	25	34	130	52	74	56	0.3	26.6	SPMT 130410 XOMT 130406	4015-M4x11		
●	28	25	34	134	56	78	56	0.3	28.6				
●	30	25	34	147	60	87	60	0.35	30.7	SPMT 130410 XOMT 130406	4015-M4x11		
●	32	32	44	151	64	91	60	0.35	32.7				
●	34	32	44	155	68	95	60	0.35	34.7	SPMT 130410 XOMT 130406	4015-M4x11		
●	36	32	44	159	72	99	60	0.35	36.7				
●	37	32	44	161	74	101	60	0.35	37.7	SPMT 130410 XOMT 130406	4015-M4x11		
●	38	32	44	163	76	103	60	0.35	38.7				

KRLY Ucuna Uygunur. / Compatible with KRLY Insert. / Под пластину KRLY



Delme Derinliği = 4x Çap
Drilling Depth = 4x Diameter
Глубина сверления = 4x Диаметр

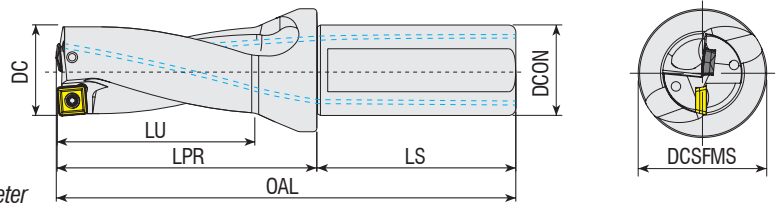

Takım Kodu
Ordering Code
Код для заказа

Stok Stock Наличие	Takım Ölçüleri (mm) Dimension (mm) Размеры (мм)								Maks. Ofset (radyal) Max. Offset (radial) Радиальное смещение		Kesici Uç Insert Пластина	Yedek Parçaları / Spare Parts / Запасные части	
	DC	DCON	DCSFMS	OAL	LU	LPR	LS	X _{max}	DC _{max}	Sıkma Vidası Screw Зажимной винт		Tork Anahtar Torx Key Торх Ключ	
●	14	20	25	128	56	78	50	0.25	14.5	SPMT 050204 XOMT 050204	3006-M2x4	82-T06	
●	14.5	20	25	128	56	78	50	0.25	15				
●	15	20	25	132	60	82	50	0.25	15.5	SPMT 060205 XOMT 060204	3007-M2.2x4.6	82-T07	
●	15.5	20	25	132	60	82	50	0.25	16				
●	16	25	34	142	64	86	56	0.25	16.5	SPMT 07T208 XOMT 07T205	3008-M2.5x6	82-T08	
●	17	25	34	146	68	90	56	0.5	18				
●	17.5	25	34	146	68	90	56	0.5	18.5	SPMT 090308 XOMT 090305	3008-M3x7		
●	18	25	34	150	72	94	56	0.5	19				
●	18.5	25	34	150	72	94	56	0.5	19.5	SPMT 130410 XOMT 130406	4015-M4x11		
●	19	25	34	154	76	98	56	0.5	20				
●	20	25	34	158	80	102	56	0.3	20.6	SPMT 130410 XOMT 130406	4015-M4x11		
●	21	25	34	162	84	106	56	0.3	21.6				
●	22	25	34	166	88	110	56	0.3	22.6	SPMT 130410 XOMT 130406	4015-M4x11		
●	24	25	34	174	96	118	56	0.3	24.6				
●	25	25	34	178	100	122	56	0.3	25.6	SPMT 130410 XOMT 130406	4015-M4x11		
●	25	25	34	178	100	122	56	0.3	25.6				

R: Sağ / Right / Правый L: Sol / Left / Левый

● Stokta / In Stock / В наличии ○ Stokta Yok / Non Stock Item / Нет в наличии

KRLY Ucuna Uygunur. / Compatible with KRLY Insert. / Под пластину KRLY

Sipariş Örneği/Ordering Example/Образец заказа

1 ad./pcs./шт. ATUM 14XD2 KDR 0502..

Takma Uçlu Matkap Kullanım Kılavuzu : S 375 / User's Guide For U-Drills : P 375 / Руководство для эксплуатации сверел: стр. 375



Delme Derinliği = 3x Çap
Drilling Depth = 3x Diameter
Глубина сверления = 3x Диаметр

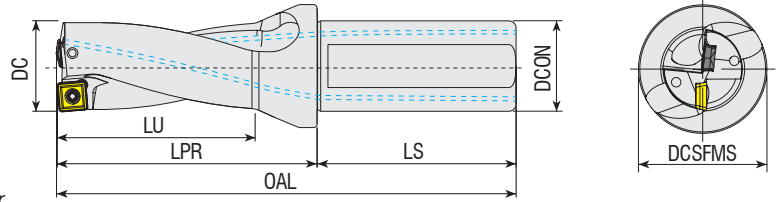

Takım Kodu
Ordering Code
Код для заказа

Stok
Stock
Наличие

Takım Ölçüleri (mm)
Dimension (mm)
Размеры (мм)

Maks. Ofset (radyal)
Max. Offset (radial)
Радиальное смещение

Kesici Uç
Insert
Пластина

Yedek Parçaları / Spare Parts / Запасные части

Sıkma Vidası
Screw
Зажимной винт

Tork Anahtar
Torx Key
Торх Ключ

Takım Kodu Ordering Code Код для заказа	Stok Stock Наличие	Takım Ölçüleri (mm) Dimension (mm) Размеры (мм)							Maks. Ofset (radyal) Max. Offset (radial) Радиальное смещение		Kesici Uç Insert Пластина	Sıkma Vidası Screw Зажимной винт	Tork Anahtar Torx Key Торх Ключ
		DC	DC ON	DCSFMS	OAL	LU	LPR	LS	X _{max} [mm]	DC _{max} [mm]			
ATUM 12.5XD3 KDR 0402..	●	12.5	20	25	108	36	58	50	0.2	12.9	SPMT 040204 XOMT 040204	3006-M2x4	82-T06
ATUM 13XD3 KDR 0402..	●	13	20	25	111	39	61	50	0.2	13.4			
ATUM 14XD3 KDR 0502..	●	14	20	25	114	42	64	50	0.25	14.5	SPMT 050204 XOMT 050204	3006-M2x4	82-T06
ATUM 14.5XD3 KDR 0502..	●	14.5	20	25	114	42	64	50	0.25	15			
ATUM 15XD3 KDR 0502..	●	15	20	25	117	45	67	50	0.25	15.5	SPMT 060205 XOMT 060204	3007-M2.2x4.6	82-T07
ATUM 15.5XD3 KDR 0502..	●	15.5	20	25	117	45	67	50	0.25	16			
ATUM 16XD3 KDR 0502..	●	16	25	34	126	48	70	56	0.25	16.5	SPMT 07T208 XOMT 07T205	3008-M2.5x6	82-T08
ATUM 16.5XD3 KDR 0602..	●	16.5	25	34	126	48	70	56	0.5	17.5			
ATUM 17XD3 KDR 0602..	●	17	25	34	129	51	73	56	0.5	18	SPMT 090308 XOMT 090305	3008-M3x7	80-T15
ATUM 17.5XD3 KDR 0602..	●	17.5	25	34	129	51	73	56	0.5	18.5			
ATUM 18XD3 KDR 0602..	●	18	25	34	132	54	76	56	0.5	19	SPMT 11T308 XOMT 11T306	4015-M3.5x9	80-T15
ATUM 18.5XD3 KDR 0602..	●	18.5	25	34	132	54	76	56	0.5	19.5			
ATUM 19XD3 KDR 0602..	●	19	25	34	135	57	79	56	0.5	20	SPMT 130410 XOMT 130406	4015-M4x11	80-T15
ATUM 19.5XD3 KDR 0602..	●	19.5	25	34	135	57	79	56	0.5	20.5			
ATUM 20XD3 KDR 07T2..	●	20	25	34	138	60	82	56	0.3	20.6	SPMT 130410 XOMT 130406	4015-M4x11	80-T15
ATUM 20.5XD3 KDR 07T2..	●	20.5	25	34	138	60	82	56	0.3	21.1			
ATUM 21XD3 KDR 07T2..	●	21	25	34	141	63	85	56	0.3	21.6	SPMT 130410 XOMT 130406	4015-M4x11	80-T15
ATUM 22XD3 KDR 07T2..	●	22	25	34	144	66	88	56	0.3	22.6			
ATUM 22.5XD3 KDR 07T2..	●	22.5	25	34	144	68	88	56	0.3	23.1	SPMT 130410 XOMT 130406	4015-M4x11	80-T15
ATUM 23XD3 KDR 07T2..	●	23	25	34	147	69	91	56	0.3	23.6			
ATUM 23.5XD3 KDR 07T2..	●	23.5	25	34	147	69	91	56	0.3	24.1	SPMT 130410 XOMT 130406	4015-M4x11	80-T15
ATUM 24XD3 KDR 0903..	●	24	25	34	150	72	94	56	0.3	24.6			
ATUM 24.5XD3 KDR 0903..	●	24.5	25	34	150	72	94	56	0.3	25.1	SPMT 130410 XOMT 130406	4015-M4x11	80-T15
ATUM 25XD3 KDR 0903..	●	25	25	34	153	75	97	56	0.3	25.6			
ATUM 26XD3 KDR 0903..	●	26	25	34	156	78	100	56	0.3	26.6	SPMT 130410 XOMT 130406	4015-M4x11	80-T15
ATUM 27XD3 KDR 0903..	●	27	25	34	159	81	103	56	0.3	27.6			
ATUM 28XD3 KDR 0903..	●	28	25	34	162	84	106	56	0.3	28.6	SPMT 130410 XOMT 130406	4015-M4x11	80-T15
ATUM 29XD3 KDR 0903..	●	29	25	34	165	87	109	56	0.3	29.6			
ATUM 30XD3 KDR 11T3..	●	30	32	44	177	90	117	60	0.35	30.7	SPMT 130410 XOMT 130406	4015-M4x11	80-T15
ATUM 32XD3 KDR 11T3..	●	32	32	44	183	96	123	60	0.35	32.7			
ATUM 33XD3 KDR 11T3..	●	33	32	44	186	99	126	60	0.35	33.7	SPMT 130410 XOMT 130406	4015-M4x11	80-T15
ATUM 34XD3 KDR 11T3..	●	34	32	44	189	102	129	60	0.35	34.7			
ATUM 35XD3 KDR 11T3..	●	35	32	44	192	105	132	60	0.35	35.7	SPMT 130410 XOMT 130406	4015-M4x11	80-T15
ATUM 37XD3 KDR 1304..	●	37	32	44	198	111	138	60	0.35	37.7			
ATUM 38XD3 KDR 1304..	●	38	32	44	201	114	141	60	0.35	38.7	SPMT 130410 XOMT 130406	4015-M4x11	80-T15
ATUM 39XD3 KDR 1304..	●	39	32	44	204	117	144	60	0.35	39.7			
ATUM 40XD3 KDR 1304..	●	40	32	44	207	120	147	60	0.35	40.7	SPMT 130410 XOMT 130406	4015-M4x11	80-T15
ATUM 40XD3 KDR 1304..	●	40	32	44	207	120	147	60	0.35	40.7			

R: Sağ / Right / Правый L: Sol / Left / Левый
● Stokta / In Stock / В наличии ○ Stokta Yok / Non Stock Item / Нет в наличии
KRLY Uçuna Uygun / Compatible with KRLY Insert. / Под пластину KRLY

Sipariş Örneği/Ordering Example/Образец заказа
1 ad./pcs./шт. ATUM 12.5XD3 KDR 0402..

Takma Uçlu Matkap Kullanım Kılavuzu : S 375 / User's Guide For U-Drills : P 375
Руководство для эксплуатации сверел : стр. 375



Delme Derinliği = 2x Çap
Drilling Depth = 2x Diameter
Глубина сверления = 2x Диаметр

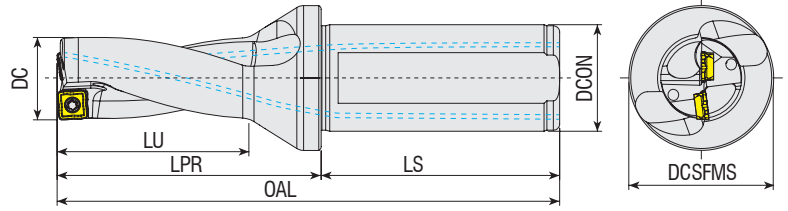

Takım Kodu Ordering Code Код для заказа	Stok Stock Наличие	Takım Ölçüleri (mm) Dimension (mm) Размеры (мм)							Maks. Ofset (radyal) Max. Offset (radial) Радиальное смещение		Kesici Uç Insert Пластина	Yedek Parçaları / Spare Parts / Запасные части	
		DC	DCON	DCSFMS	OAL	LU	LPR	LS	X _{max} [mm]	DC _{max} [mm]		Sıkma Vidası Screw Зажимной винт	Tork Anahtar Torx Key Торх Ключ
ATUM 14XD2 SOMT 050204	●	14	20	25	100	28	50	50	0.5	15	SOMT 050204	3006-M2x4	82-T06
ATUM 16XD2 SOMT 050204	●	16	25	34	110	32	54	56	0.3	16.6			
ATUM 17XD2 SOMT 060204	●	17	25	34	112	34	56	56	0.5	18	SOMT 060204	3007-M2.2x4.6	82-T07
ATUM 18XD2 SOMT 060204	●	18	25	34	114	36	58	56	0.4	18.8			
ATUM 20XD2 SOMT 070306	●	20	25	34	118	40	62	56	0.5	21	SOMT 070306		
ATUM 22XD2 SOMT 070306	●	22	25	34	122	44	66	56	0.3	22.6			
ATUM 23XD2 SOMT 08T306	●	23	25	34	124	46	68	56	0.5	24	SOMT 08T306	3008-M2.5x6	82-T08
ATUM 24XD2 SOMT 08T306	●	24	25	34	126	48	70	56	0.5	25			
ATUM 25XD2 SOMT 08T306	●	25	25	34	128	50	72	56	0.4	25.8	SOMT 08T306		
ATUM 26XD2 SOMT 08T306	●	26	25	34	130	52	74	56	0.3	26.6			
ATUM 27XD2 SOMT 09T308	●	27	25	34	132	54	76	56	0.5	28	SOMT 09T308		
ATUM 28XD2 SOMT 09T308	●	28	25	34	134	56	78	56	0.5	29			
ATUM 29XD2 SOMT 09T308	●	29	25	34	136	58	80	56	0.5	30	SOMT 09T308	4015-M3.5x9	80-T15
ATUM 30XD2 SOMT 09T308	●	30	32	44	147	60	87	60	0.5	31			
ATUM 32XD2 SOMT 11T308	●	32	32	44	151	64	91	60	0.5	33	SOMT 11T308		
ATUM 33XD2 SOMT 11T308	●	33	32	44	153	66	93	60	0.5	34			
ATUM 34XD2 SOMT 11T308	●	34	32	44	155	68	95	60	0.5	35	SOMT 11T308		
ATUM 35XD2 SOMT 11T308	●	35	32	44	157	70	97	60	0.5	36			
ATUM 37XD2 SOMT 130408	●	37	32	44	161	74	101	60	0.5	38	SOMT 130408	4015-M4x11	
ATUM 38XD2 SOMT 130408	●	38	32	44	163	76	103	60	0.5	39			
ATUM 40XD2 SOMT 130408	●	40	32	44	167	80	107	60	0.5	41	SOMT 130408		
ATUM 45XD2 SOMT 150510	●	45	40	54	192	90	122	70	0.5	46			
ATUM 47XD2 SOMT 150510	●	47	40	54	196	94	126	70	0.5	48	SOMT 150510	1020-M5x11	80-T20

R: Sağ / Right / Правый L: Sol / Left / Левый
● Stokta / In Stock / В наличии ○ Stokta Yok / Non Stock Item / Нет в наличии
TGTC Uçuna Uygundur. / Compatible with TGTC Insert. / Под пластину TGTC.

Sipariş Örneği/Ordering Example/Образец заказа
1 ad./pcs./шт. ATUM 14XD2 SOMT 050204

Takma Uçlu Matkap Kullanım Kılavuzu : S 375 / User's Guide For U-Drills : P 375
Руководство для эксплуатации сверел: стр. 375



Delme Derinliği = 3x Çap
Drilling Depth = 3x Diameter
Глубина сверления = 3x Диаметр

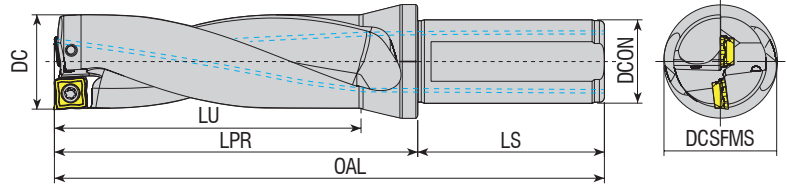

Takım Kodu
Ordering Code
Код для заказа

Stok
Stock
Наличие

Takım Ölçüleri (mm)
Dimension (mm)
Размеры (мм)

Maks. Ofset (radyal)
Max. Offset (radial)
Радиальное смещение

Kesici Uç
Insert
Пластина

Yedek Parçaları / Spare Parts / Запасные части

Sıkma Vidası
Screw
Зажимной винт

Tork Anahtar
Torx Key
Торх Ключ

Takım Kodu Ordering Code Код для заказа	Stok Stock Наличие	Takım Ölçüleri (mm) Dimension (mm) Размеры (мм)							Maks. Ofset (radyal) Max. Offset (radial) Радиальное смещение		Kesici Uç Insert Пластина	Sıkma Vidası Screw Зажимной винт	Tork Anahtar Torx Key Торх Ключ
		DC	DCON	DCSFMS	OAL	LU	LPR	LS	X _{max} X _{max} [mm]	DC _{max} DC _{max} [mm]			
ATUM 14XD3 SOMT 050204	●	14	20	25	114	42	64	50	0.5	15	SOMT 050204	3006-M2x4	82-T06
ATUM 14.5XD3 SOMT 050204	●	14.5	20	25	114	42	64	50	0.4	15.3			
ATUM 15XD3 SOMT 050204	●	15	20	25	117	45	67	50	0.4	15.8			
ATUM 15.5XD3 SOMT 050204	●	15.5	20	25	117	45	67	50	0.3	16.1			
ATUM 16XD3 SOMT 050204	●	16	25	34	126	48	70	56	0.3	16.6	SOMT 060204	3007-M2.2x4.6	82-T07
ATUM 16.5XD3 SOMT 060204	●	16.5	25	34	126	48	70	56	0.5	17.5			
ATUM 17XD3 SOMT 060204	●	17	25	34	129	51	73	56	0.5	18			
ATUM 17.5XD3 SOMT 060204	●	17.5	25	34	129	51	73	56	0.4	18.3			
ATUM 18XD3 SOMT 060204	●	18	25	34	132	54	76	56	0.4	18.8	SOMT 070306	3008-M2.5x6	82-T08
ATUM 18.5XD3 SOMT 060204	●	18.5	25	34	132	54	76	56	0.3	19.1			
ATUM 19XD3 SOMT 060204	●	19	25	34	135	57	79	56	0.3	19.6			
ATUM 19.5XD3 SOMT 070306	●	19.5	25	34	135	57	79	56	0.5	20.5			
ATUM 20XD3 SOMT 070306	●	20	25	34	138	60	82	56	0.5	21	SOMT 08T306	4015-M3.5x9	80-T15
ATUM 20.5XD3 SOMT 070306	●	20.5	25	34	138	60	82	56	0.4	21.3			
ATUM 21XD3 SOMT 070306	●	21	25	34	141	63	85	56	0.4	21.8			
ATUM 22XD3 SOMT 070306	●	22	25	34	144	66	88	56	0.3	22.6			
ATUM 22.5XD3 SOMT 08T306	●	22.5	25	34	144	66	88	56	0.5	23.5	SOMT 09T308	4015-M4x11	80-T20
ATUM 23XD3 SOMT 08T306	●	23	25	34	147	69	91	56	0.5	24			
ATUM 23.5XD3 SOMT 08T306	●	23.5	25	34	147	69	91	56	0.5	24.5			
ATUM 24XD3 SOMT 08T306	●	24	25	34	150	72	94	56	0.5	25			
ATUM 24.5XD3 SOMT 08T306	●	24.5	25	34	150	72	94	56	0.4	25.3	SOMT 11T308	1020-M5x11	80-T20
ATUM 25XD3 SOMT 08T306	●	25	25	34	153	75	97	56	0.4	25.8			
ATUM 26XD3 SOMT 08T306	●	26	25	34	156	78	100	56	0.3	26.6			
ATUM 27XD3 SOMT 09T308	●	27	25	34	159	81	103	56	0.5	28			
ATUM 27.5XD3 SOMT 09T308	●	27.5	25	34	159	81	103	56	0.5	27.5	SOMT 130408	1020-M5x11	80-T20
ATUM 28XD3 SOMT 09T308	●	28	25	34	162	84	106	56	0.5	29			
ATUM 29XD3 SOMT 09T308	●	29	25	34	165	87	109	56	0.5	30			
ATUM 30XD3 SOMT 09T308	●	30	32	44	177	90	117	60	0.5	31			
ATUM 32XD3 SOMT 11T308	●	32	32	44	183	96	123	60	0.5	33	SOMT 150510	1020-M5x11	80-T20
ATUM 33XD3 SOMT 11T308	●	33	32	44	186	99	126	60	0.5	34			
ATUM 34XD3 SOMT 11T308	●	34	32	44	189	102	129	60	0.5	35			
ATUM 35XD3 SOMT 11T308	●	35	32	44	192	105	132	60	0.5	36			
ATUM 36XD3 SOMT 11T308	●	36	32	44	195	108	135	60	0.4	36.8	SOMT 150510	1020-M5x11	80-T20
ATUM 37XD3 SOMT 130408	●	37	32	44	198	111	138	60	0.5	38			
ATUM 38XD3 SOMT 130408	●	38	32	44	201	114	141	60	0.5	39			
ATUM 39XD3 SOMT 130408	●	39	32	44	204	117	144	60	0.5	40			
ATUM 40XD3 SOMT 130408	●	40	32	44	207	120	147	60	0.5	41	SOMT 150510	1020-M5x11	80-T20
ATUM 45XD3 SOMT 150510	●	45	40	54	237	135	167	70	0.5	46			
ATUM 49XD3 SOMT 150510	●	49	40	54	249	147	179	70	0.5	50			
ATUM 50XD3 SOMT 150510	●	50	40	54	252	150	182	70	0.5	51			

R: Sağ / Right / Правый L: Sol / Left / Левый

● Stokta / In Stock / В наличии ○ Stokta Yok / Non Stock Item / Нет в наличии

TGTC Ucuna Uygundur. / Compatible with TGTC Insert. / Под пластину TGTC.

Sipariş Örneği/Ordering Example/Образец заказа

1 ad./pcs./шт. ATUM 14XD3 SOMT 050204

Takma Uçlu Matkap Kullanım Kılavuzu : S 375 / User's Guide For U-Drills : P 375

Руководство для эксплуатации сверел: стр. 375



Delme Derinliği = 4x Çap
Drilling Depth = 4x Diameter
Глубина сверления = 4x Диаметр

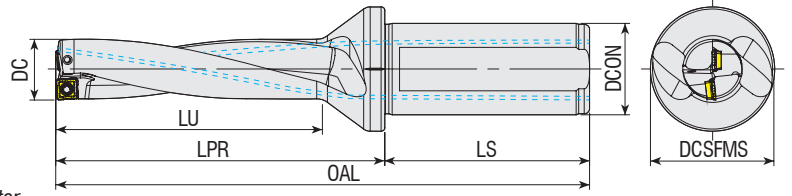

Takım Kodu Ordering Code Код для заказа	Stok Stock Наличие	Takım Ölçüleri (mm) Dimension (mm) Размеры (мм)							Maks. Ofset (radyal) Max. Offset (radial) Радиальное смещение	Kesici Uç Insert Пластина	Yedek Parçaları / Spare Parts / Запасные части		
		DC	DCON	DCSFMS	OAL	LU	LPR	LS			Sikma Vidası Screw Зажимной винт	Tork Anahtar Torx Key Торх Ключ	
ATUM 14XD4 SOMT 050204	●	14	20	25	128	56	78	50	0.5	15	SOMT 050204	3006-M2x4	82-T06
ATUM 14.5XD4 SOMT 050204	●	14.5	20	25	128	56	78	50	0.4	15.3			
ATUM 16XD4 SOMT 050204	●	16	25	34	142	64	86	56	0.3	16.6			
ATUM 17XD4 SOMT 060204	●	17	25	34	146	68	90	56	0.5	18			
ATUM 17.5XD4 SOMT 060204	●	17.5	25	34	146	68	90	56	0.4	18.3	SOMT 060204	3007-M2.2x4.6	82-T07
ATUM 18XD4 SOMT 060204	●	18	25	34	150	72	94	56	0.4	18.8			
ATUM 19XD4 SOMT 060204	●	19	25	34	154	76	98	56	0.3	19.6			
ATUM 20XD4 SOMT 070306	●	20	25	34	158	80	102	56	0.5	21	SOMT 070306		
ATUM 21XD4 SOMT 070306	●	21	25	34	162	84	106	56	0.4	21.8			
ATUM 22XD4 SOMT 070306	●	22	25	34	166	88	110	56	0.3	22.6	SOMT 08T306	3008-M2.5x6	82-T08
ATUM 24XD4 SOMT 08T306	●	24	25	34	174	96	118	56	0.5	25			
ATUM 25XD4 SOMT 08T306	●	25	25	34	178	100	122	56	0.4	25.8			

R: Sağ / Right / Правый L: Sol / Left / Левый
● Stokta / In Stock / В наличии ○ Stokta Yok / Non Stock Item / Нет в наличии
TGTC Ucuна Uygundur. / Compatible with TGTC Insert. / Под пластину TGTC.

Sipariş Örneği/Ordering Example/Образец заказа
1 ad./pcs./шт. ATUM 14XD4 SOMT 050204
Takma Uçlu Matkap Kullanım Kılavuzu : S 375 / User's Guide For U-Drills : P 375
Руководство для эксплуатации сверел: стр. 375





Delme Derinliği = 5x Çap
Drilling Depth = 5x Diameter
Глубина сверления = 5x Диаметр

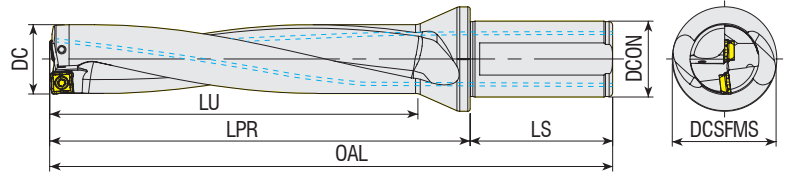

Takım Kodu
Ordering Code
Код для заказа

Stok Stock Наличие	Takım Ölçüleri (mm) Dimension (mm) Размеры (мм)								Maks. Ofset (radyal) Max. Offset (radial) Радиальное смещение		Kesici Uç Insert Пластина	Sıkma Vidası Screw Зажимной винт	Tork Anahtar Torx Key Торх Ключ
	DC	DCON	DCSFMS	OAL	LU	LPR	LS	X_{max}	DC_{max}				
ATUM 14XD5 SOMT 050204	●	14	20	25	142	70	92	50	0.5	15	SOMT 050204	3006-M2x4	82-T06
ATUM 15XD5 SOMT 050204	●	15	20	25	147	75	97	50	0.4	15.8			
ATUM 15.5XD5 SOMT 050204	●	15.5	20	25	147	75	97	50	0.3	16.1			
ATUM 16XD5 SOMT 050204	●	16	25	34	158	80	102	56	0.3	16.6			
ATUM 16.5XD5 SOMT 060204	●	16.5	25	34	158	80	102	56	0.5	17.5	SOMT 060204	3007-M2.2x4.6	82-T07
ATUM 17.5XD5 SOMT 060204	●	17.5	25	34	163	85	107	56	0.4	18.3			
ATUM 18XD5 SOMT 060204	●	18	25	34	168	90	112	56	0.4	18.8			
ATUM 18.5XD5 SOMT 060204	●	18.5	25	34	168	90	112	56	0.3	19.1			
ATUM 19XD5 SOMT 060204	●	19	25	34	173	95	117	56	0.3	19.6	SOMT 070306	3008-M2.5x6	82-T08
ATUM 19.5XD5 SOMT 070306	●	19.5	25	34	173	95	117	56	0.5	20.5			
ATUM 20XD5 SOMT 070306	●	20	25	34	178	100	122	56	0.5	21			
ATUM 21XD5 SOMT 070306	●	21	25	34	183	105	127	56	0.4	21.8			
ATUM 22XD5 SOMT 070306	●	22	25	34	188	110	132	56	0.3	22.6	SOMT 08T306	3008-M2.5x6	82-T08
ATUM 23XD5 SOMT 08T306	●	23	25	34	193	115	137	56	0.5	24			
ATUM 24XD5 SOMT 08T306	●	24	25	34	198	120	142	56	0.5	25			
ATUM 25XD5 SOMT 08T306	●	25	25	34	203	125	147	56	0.4	25.8			
ATUM 26XD5 SOMT 08T306	●	26	25	34	208	130	152	56	0.3	26.6	SOMT 09T308	4015-M3.5x9	80-T15
ATUM 27XD5 SOMT 09T308	●	27	25	34	213	135	157	56	0.5	28			
ATUM 28XD5 SOMT 09T308	●	28	25	34	218	140	162	56	0.5	29			
ATUM 29XD5 SOMT 09T308	●	29	25	34	223	145	167	56	0.5	30			
ATUM 30XD5 SOMT 09T308	●	30	32	44	237	150	177	60	0.5	31	SOMT 11T308	4015-M3.5x9	80-T15
ATUM 33XD5 SOMT 11T308	●	33	32	44	252	165	192	60	0.5	34			
ATUM 34XD5 SOMT 11T308	●	34	32	44	257	170	197	60	0.5	35			
ATUM 35XD5 SOMT 11T308	●	35	32	44	262	175	202	60	0.5	36			
ATUM 36XD5 SOMT 11T308	●	36	32	44	267	180	207	60	0.4	36.8			

R: Sağ / Right / Правый L: Sol / Left / Левый
● Stokta / In Stock / В наличии ○ Stokta Yok / Non Stock Item / Нет в наличии
TGTC Uçuna Uygundur. / Compatible with TGTC Insert. / Под пластину TGTC.

Sipariş Örneği/Ordering Example/Образец заказа
1 ad./pcs./шт. ATUM 14XD5 SOMT 050204
Takma Uçlu Matkap Kullanım Kılavuzu : S 375 / User's Guide For U-Drills : P 375
Руководство для эксплуатации сверел: стр. 375



Delme Derinliği = 3x Çap
Drilling Depth = 3x Diameter
Глубина сверления = 3x Диаметр

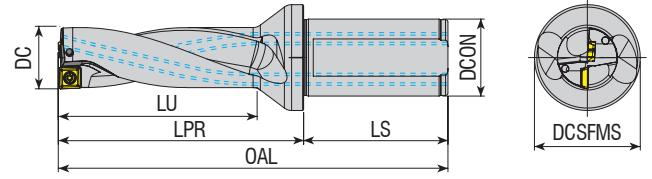

Takım Kodu Ordering Code Код для заказа	Stok Stock Наличие	Takım Ölçüleri (mm) Dimension (mm) Размеры (мм)								Maks. Ofset (radyal) Max. Offset (radial) Радиальное смещение		Kesici Uç Insert Пластина	Yedek Parçaları / Spare Parts / Запасные части	
		DC	DCON	DCSFMS	OAL	LU	LPR	LS	X _{max}	DC _{max}	Sıkma Vidası Screw Зажимной винт		Tork Anahtar Torx Key Торх Ключ	
ATUM 14XD3 880-0202..	●	14	20	25	108	42	58	50	0.5	15	880-02...C/P	3006-M2x4	82-T06	
ATUM 14.5XD3 880-0202..	●	14.5	20	25	110	46	60	50	0.45	15.4				
ATUM 15XD3 880-0202..	●	15	20	25	112	48	62	50	0.4	15.8				
ATUM 15.5XD3 880-0202..	●	15.5	20	25	114	50	64	50	0.3	16.1				
ATUM 16XD3 880-0202..	●	16	20	25	116	51	66	50	0.3	16.6				
ATUM 16.5XD3 880-0303..	●	16.5	20	25	118	53	68	50	0.6	17.7	880-03...C/P	3007-M2.2x4.6	82-T07	
ATUM 17XD3 880-0303..	●	17	20	25	119	54	69	50	0.6	18.2				
ATUM 17.5XD3 880-0303..	●	17.5	25	32	128	56	72	56	0.5	18.5				
ATUM 18XD3 880-0303..	●	18	25	32	129	57	73	56	0.4	18.8				
ATUM 18.5XD3 880-0303..	●	18.5	25	32	131	59	75	56	0.4	19.3				
ATUM 19XD3 880-0303..	●	19	25	32	132	60	76	56	0.3	19.6				
ATUM 19.5XD3 880-0303..	●	19.5	25	32	135	62	79	56	0.3	20.1				
ATUM 20XD3 880-0403..	●	20	25	32	137	64	81	56	0.9	21.8				
ATUM 20.5XD3 880-0403..	●	20.5	25	32	138	65	82	56	0.8	22.1	880-04...C/P	3008-M2.5x6	82-T08	
ATUM 21XD3 880-0403..	●	21	25	32	140	66	84	56	0.8	22.6				
ATUM 21.5XD3 880-0403..	●	21.5	25	32	142	68	86	56	0.7	22.9				
ATUM 22XD3 880-0403..	●	22	25	32	143	69	87	56	0.6	23.2				
ATUM 22.5XD3 880-0403..	●	22.5	25	32	146	71	90	56	0.5	23.5				
ATUM 23XD3 880-0403..	●	23	25	32	147	72	91	56	0.5	24				
ATUM 23.5XD3 880-0403..	●	23.5	25	34	149	69	93	56	0.4	24.3				
ATUM 24XD3 880-0503..	●	24	25	32	151	76	95	56	1.1	26.2	880-05...C/P	4010-M3x8	82-T10	
ATUM 25XD3 880-0503..	●	25	25	32	155	79	99	56	1	27				
ATUM 26XD3 880-0503..	●	26	32	44	162	81	102	60	0.9	27.8				
ATUM 27XD3 880-0503..	●	27	32	44	165	84	105	60	0.7	28.4				
ATUM 28XD3 880-0503..	●	28	32	44	169	87	109	60	0.6	29.2				
ATUM 29XD3 880-0503..	●	29	32	44	172	90	112	60	0.5	30				
ATUM 30XD3 880-0604..	●	30	32	44	177	94	117	60	1.1	32.2	880-06...C/P	3010-M3.5x9	82-T10	
ATUM 31XD3 880-0604..	●	31	40	54	191	97	121	70	1	33				
ATUM 32XD3 880-0604..	●	32	40	54	194	100	124	70	0.9	33.8				
ATUM 33XD3 880-0604..	●	33	40	54	198	103	128	70	0.7	34.4				
ATUM 34XD3 880-0604..	●	34	40	54	201	106	131	70	0.5	35				
ATUM 35XD3 880-0604..	●	35	40	54	205	109	135	70	0.4	35.8				
ATUM 36XD3 880-0704..	●	36	40	54	209	112	139	70	1.3	38.6				
ATUM 38XD3 880-0704..	●	38	40	54	216	118	146	70	1.1	40.2	880-07...C/P	3010-M3.5x9	80-T15	
ATUM 39XD3 880-0704..	●	39	40	54	219	121	149	70	1	41				
ATUM 40XD3 880-0704..	●	40	40	54	223	124	153	70	0.8	41.6				
ATUM 41XD3 880-0704..	●	41	40	54	227	127	157	70	0.7	42.4				
ATUM 42XD3 880-0704..	●	42	40	54	230	130	160	70	0.6	43.2				
ATUM 45XD3 880-0805..	●	45	40	54	242	140	172	70	1.4	47.8	880-08...C/P	4015-M4x11	80-T15	
ATUM 46XD3 880-0805..	●	46	40	54	246	143	176	70	1.3	48.6				
ATUM 48XD3 880-0805..	●	48	40	54	253	149	183	70	1	50				
ATUM 50XD3 880-0805..	●	50	40	54	260	155	190	70	0.8	51.6				

R: Sağ / Right / Правый L: Sol / Left / Левый

● Stokta / In Stock / В наличии ○ Stokta Yok / Non Stock Item / Нет в наличии

SNDVK Ucuna Uygundur. / Compatible with SNDVK Insert. / Под пластину SNDVK



www.akkо.com.tr

Sipariş Örneği/Ordering Example/Образец заказа

1 ad./pcs./шт. ATUM 14XD3 880-0202..

Takma Uçlu Matkap Kullanım Kılavuzu : S 375 / User's Guide For U-Drills : P 375

Руководство для эксплуатации сверел: стр. 375

HELİSEL İÇTEN SU VERME KANALLI MATKAPLAR

INDEXABLE DRILLS WITH HELICAL COOLANT HOLE

Farklı çaplarda ve ALFA KAPLAMA teknolojisi ile siparişe hazır.

They are ready to order in different diameters and with ALPHA COATING technology.

- Helisel içten su verme kanallı • **Helical Internal Coolant Holes**
- Üstün Alpha Kaplama Teknolojisi • **Superior Alpha Coating Technology**
- 1000 Vickers'e dayanan yüksek yüzey sertliği • **High surface hardness up to 1000 Vickers**
- Aşınmaya karşı yüksek direnç • **High resistance to abrasion**
- Dengeli ve hassas kesim • **Balanced and precise cutting**

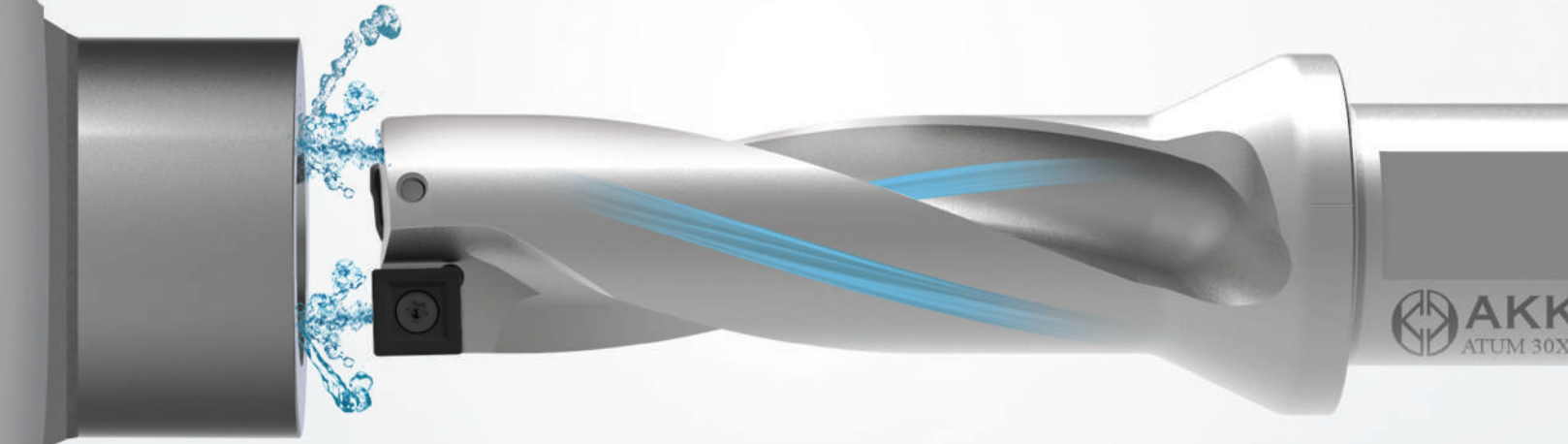

AKKO HELİSEL KANAL TEKNOLOJİSİ
AKKO HELICAL CHANNEL TECHNOLOGY

RAKİPLER
COMPETITORS



* STOK DURUMU / STOCK STATUS

D2 / D3 / D4 / D5

* Helisel İçten Su Verme Kanalı
Twisted Coolant Hole

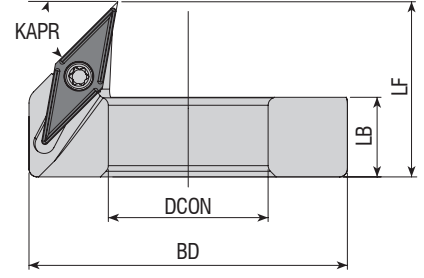

Takım Kodu Ordering Code Код для заказа	Stok Stock Наличие	Takım Ölçüleri (mm) Dimension (mm) Размеры (мм)				Kullanılacak ATUM Ölçüsü Compatible ATUM Diameter Кольцевой Калибр	Yedek Parçaları / Spare Parts / Запасные части				
		BD	DCON	LB	LF		ATUM Ø	Kesici Uç Insert Пластина	Sıkma Vidası Screw Зажимной Винт	Tork Anahtar Torx Key Торх Ключ	Montaj Vidası Mounting Screw Монтажный Винт
ADCR-120-VB1103	●	32	12	10	22	12.5					
ADCR-125-VB1103	●	32.5	12.5	10	22	13					
ADCR-130-VB1103	●	33	13	10	22	13.5					
ADCR-135-VB1103	●	33.5	13.5	10	22	14					
ADCR-140-VB1103	●	34	14	10	22	14.5					
ADCR-145-VB1103	●	34.5	14.5	10	22	15					
ADCR-150-VB1103	●	35	15	10	22	15.5 - 16					
ADCR-155-VB1103	●	35.5	15.5	10	22	16.5					
ADCR-160-VB1103	●	36	16	10	22	17					
ADCR-165-VB1103	●	36.5	16.5	10	22	17.5					
ADCR-170-VB1103	●	37	17	10	22	18					
ADCR-175-VB1103	●	37.5	17.5	10	22	18.5					
ADCR-180-VB1103	●	38	18	10	22	19					
ADCR-185-VB1103	●	38.5	18.5	10	22	19.5					
ADCR-190-VB1103	●	39	19	10	22	20					
ADCR-195-VB1103	●	39.5	19.5	10	22	20.5					
ADCR-200-VB1103	●	40	20	10	22	21					
ADCR-205-VB1103	●	40.5	20.5	10	22	21.5					
ADCR-210-VB1103	●	41	21	10	22	22	VB.T 1103..	4008-M2.5x6	82-T08	AAV-14-M5x14	AAL-03-3
ADCR-215-VB1103	●	41.5	21.5	10	22	22.5					
ADCR-220-VB1103	●	42	22	10	22	23					
ADCR-225-VB1103	●	42.5	22.5	10	22	23.5					
ADCR-230-VB1103	●	43	23	10	22	24					
ADCR-235-VB1103	●	43.5	23.5	10	22	24.5					
ADCR-240-VB1103	●	44	24	10	22	25					
ADCR-245-VB1103	●	44.5	24.5	10	22	25.5					
ADCR-250-VB1103	●	45	25	10	22	26					
ADCR-255-VB1103	●	45.5	25.5	10	22	26.5					
ADCR-260-VB1103	●	46	26	10	22	27					
ADCR-265-VB1103	●	46.5	26.5	10	22	27.5					
ADCR-270-VB1103	●	47	27	10	22	28					
ADCR-275-VB1103	●	47.5	27.5	10	22	28.5					
ADCR-280-VB1103	●	48	28	10	22	29					
ADCR-285-VB1103	●	48.5	28.5	10	22	29.5					
ADCR-290-VB1103	●	49	29	10	22	30					
ADCR-295-VB1103	●	49.5	29.5	10	22	30.5					
ADCR-300-VB1103	●	50	30	10	22	31					

R: Sağ / Right / Правый L: Sol / Left / Левый

● Stokta / In Stock / В наличии ○ Stokta Yok / Non Stock Item / Нет в наличии
ISO Uçuna Uygundur. / Compatible with ISO Insert. / Под пластину ISO.

Sipariş Örneği/Ordering Example/Образец заказа

1 ad./pcs./шт. ADCR-120-VB1103

Delik Pahlama Bileziği Kullanım Kılavuzu : S 219 / User's Guide For Drill Chamfering Ring Tools : P 219

КОЛЬЦА ДЛЯ СНЯТИЯ ФАСКИ: стр. 219

Tavsiye Edilen / Recommended / Рекомендации

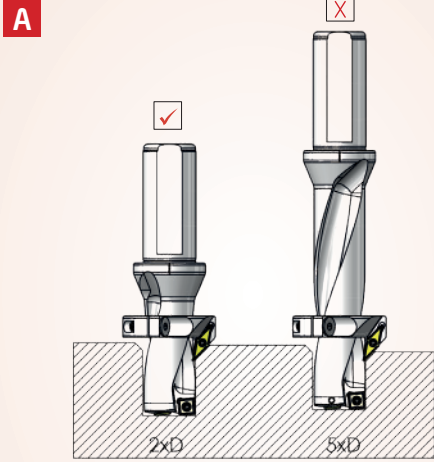

Mümkünse, her zaman kısa bir delme takımı kullanın. Değilse, titreşimi en aza indirmek için kesme hızını azaltın.
 If possible, use it always short drilling tools. Otherwise, reduce your speeds to minimize vibration.
 По возможности используйте на коротких сверлах. В противном случае, уменьшите скорость вращения, чтобы минимизировать вибрацию

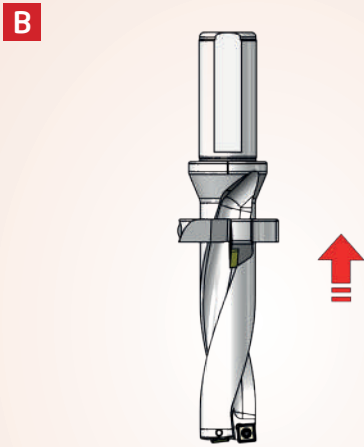

Mümkün olduğunca pah kırma halkasını shaft kısmına yakın montaj yap.
 Get close to the mounting shaft of the chamfering ring as possible.
 Установите фасочное кольцо как можно ближе к хвостовику

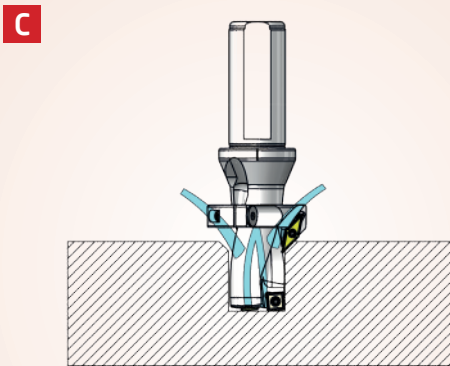

Daha iyi uç ömrü için harici soğutucu ve matkap ucu iç soğutucu uygulamak.
 Apply external cooling and internal coolant drill for a better life for inserts.
 Применяйте наружную и внутреннюю подачу СОЖ для продления срока службы пластин.

Montaj Şekli / Mounting System / Система установки



Matkap gövdesi üzerine pah kırma halkasını takın.
 Put the chamfering ring to drill body.
 Наденьте кольцо на сверло

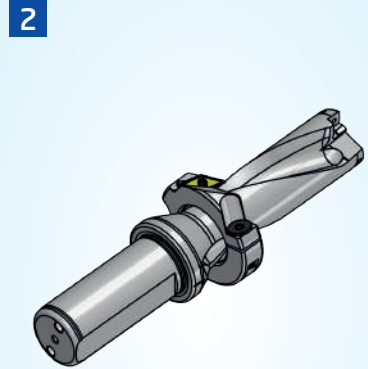

İstenilen konuma pah kırma halkasını kaydırın.
 Please slide chamfering ring to the desired position.
 Установите кольцо в нужном положении

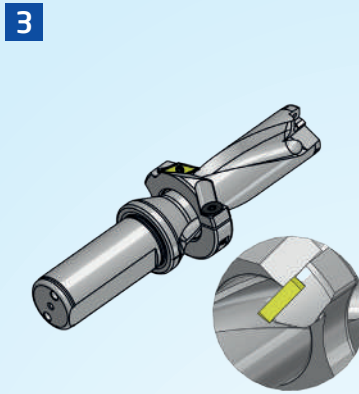

Pah kırma halkasını talaş akışına mani olmayacak şekilde helis başlangıcına denk getirin.
 Please keep chamfering ring position which will not resist to fluiding chips and try to be equal to the helix start points.
 Пожалуйста, зафиксируйте кольцо в таком положении, чтобы оно не препятствовало отводу стружки и было соосно начальным точкам спирали сверла.

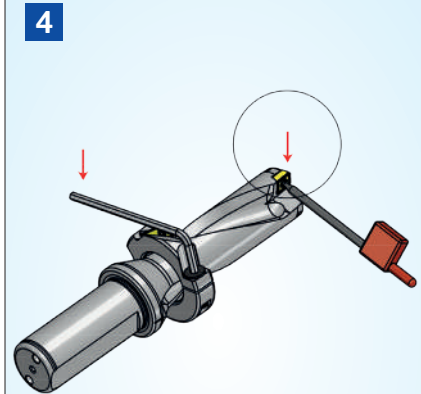

Pah kırma halkasını sıkın ve matkabin uçlarını takın.
 Tightening the chamfering ring and put the drill insert.
 Затяните фасочное кольцо и вставьте пластины в сверло

Pah kırma halkasının doğru montaj şekli.
 Proper installation of chamfering rings.
 Правильная установка колец для снятия фаски.

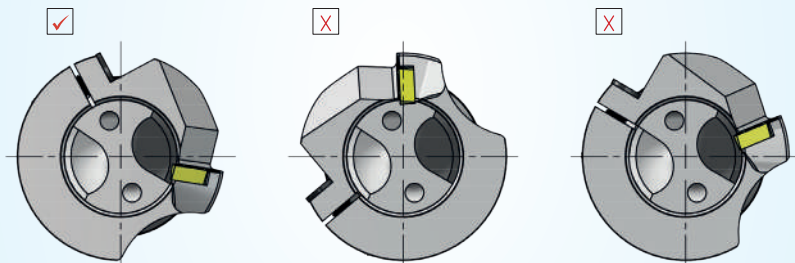

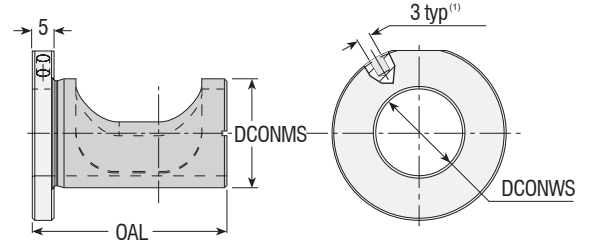

Takım Kodu Ordering Code Код для заказа	Stok Stock Наличие	Takım Ölçüleri (mm) Dimension (mm) Размеры (мм)		
		DCONWS	DCONMS	OAL
AET-2025	●	20	25	44
AET-2532	●	25	32	46
AET-3240	●	32	40	55

■ ⁽¹⁾Delik ince bir metal yardımıyla adaptörün radyal olarak ayarlanmasını kolaylaştırmak için kullanılır. / Holes for inserting a pin, used to facilitate radial adjustment of the sleeve (pin not supplied).
 Bohrung zum Einsetzen eines Stiftes mit dem der Adapter radial eingestellt werden kann (Stift ist nicht im Lieferumfang enthalten).

Frezeleme tezgahında takma uçlu matkabın nominal çapı, matkabın ekseninin, spindle eksenine göre ötelenmesiyle değiştirilebilir.
 On a milling machine the drill's nominal diameter can be changed by shifting the drill's axis out of the tool spindle.

На фрезерном станке номинальный диаметр сверла можно изменить, сместив ось сверла относительно оси шпинделя.

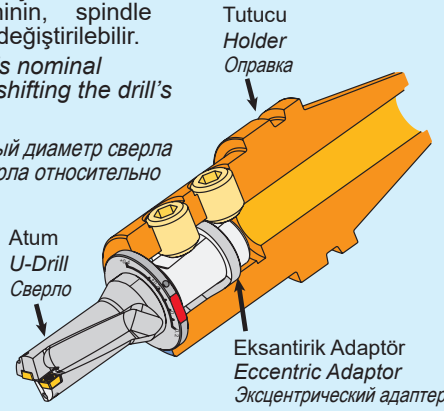

Radyal ayarlama pimi.
(Verilmeyecektir.)

Radial adjustment pin.
(not supplied)

Штифт для радиальной регулировки
(в комплект не входит)

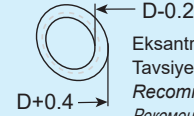
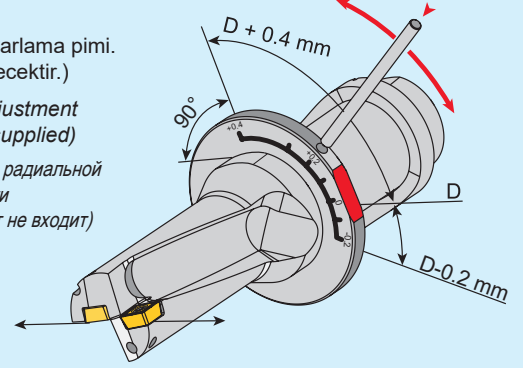

Eksantrik Adaptörü Kullanırken (AET)
 Tavsiye Edilen İlerleme Hızı
 Recommended Feed When Using Eccentric Adaptor
 Рекомендуемая скорость подачи при использовании эксцентриского адаптера

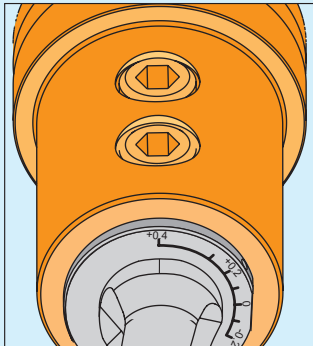
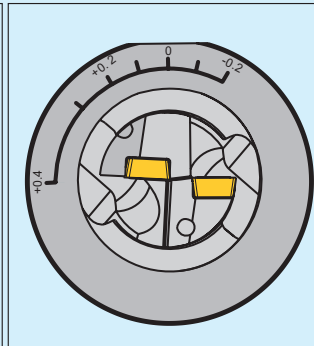
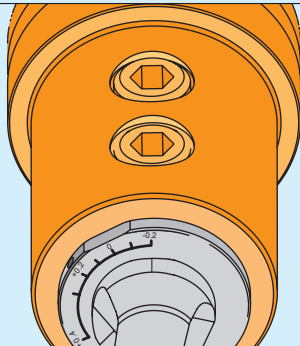
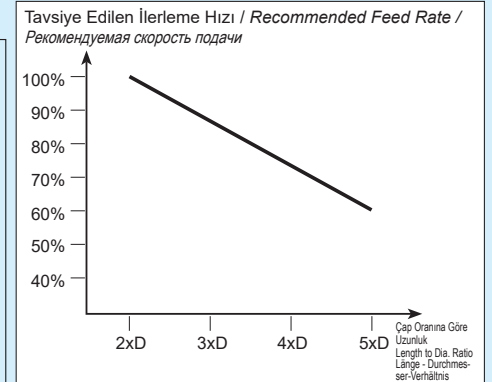

Delik Çapı
24.8 mm
Hole Diameter
Диаметр отверстия

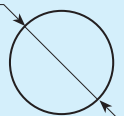

U-Drill Çapı = 25 mm
Drill Diameter = 25 mm
Диаметр сверла = 25 мм

Delik Çapı
25 mm
Hole Diameter
Диаметр отверстия

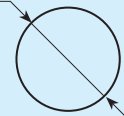

U-Drill Çapı = 25 mm
Drill Diameter = 25 mm
Диаметр сверла = 25 мм

Delik Çapı
25.4 mm
Hole Diameter
Диаметр отверстия

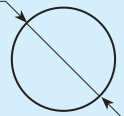

U-Drill Çapı = 25 mm
Drill Diameter = 25 mm
Диаметр сверла = 25 мм

ATUM'un üzerindeki düz çizgi adaptörün sıfır rakamının üzerine konulmalıdır. AET'nin (eksantrik adaptörün) çevrilmesini kolaylaştırmak için AET'nin üzerindeki deliğe, metal bir çubuk ya da vida anahtarları yerleştirilebilir. AET'yi ayarlama önce tutucunun vidasını hafifçe çözün.
 The adjustment markings should be located perpendicular to the flat on the circumference of the U-DRILL flange.
 To facilitate the rotation of the adaptor, a metal rod or a screw key may be inserted into a hole on the excentric adaptor flange. Unlock adaptor screw before adjusting adaptor.
 Регулировочные метки должны быть расположены перпендикулярно к прямой по окружности фланца сверла.
 Чтобы облегчить вращение адаптера металлический шток или ключ необходимо вставить в отверстие во фланец эксцентриского адаптера.
 Отпустите винт адаптера перед его настройкой.

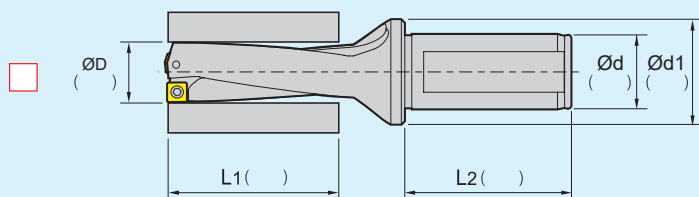
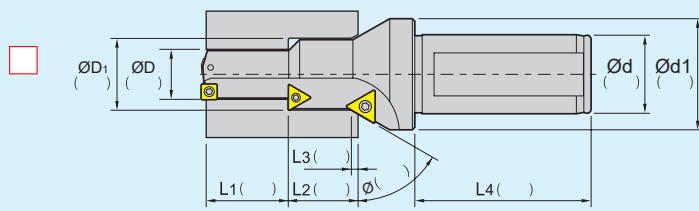
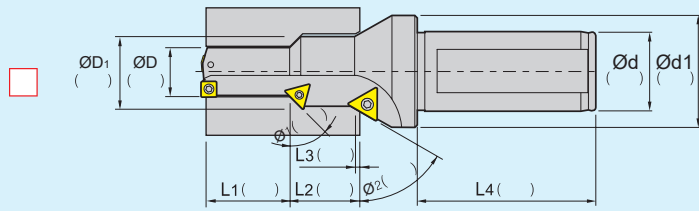
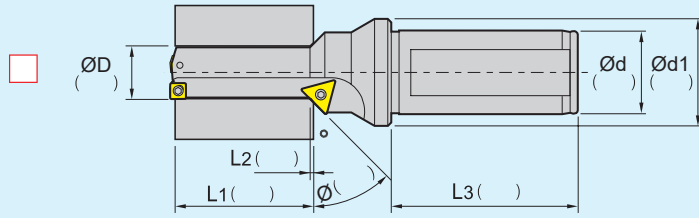
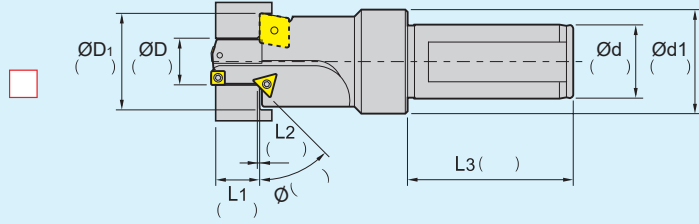

• Soğutma Tipi / Coolant type / Тип охлаждения

Yağ Deliği Dalma Kismında
Oil Hole On the Plunge Part
Боковая подача СОЖ

Yağ Deliği Şaft Kismında
"Oil hole On the Shank"
Подача СОЖ через хвостовик

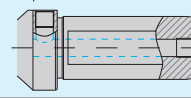

• Delik Tipi / Hole Type / Тип отверстия

Kapalı Delik
Blind Hole
Глухое отверстие

Açık Delik
Thru Hole
Сквозное отверстие

• Şaft Tipleri / Types of Shank / Типы хвостовика

Düz Tip
Flat Type
Цилиндрический хвостовик

Weldon Tip
Weldon Type
Хвостовик "Weldon"

Eğimli Yargı Tipi
Whistle Notch Type
Хвостовик с лыской

• Yargı Bağlama Yeri / Location of Side Lock / Расположение лыски хвостовика

Dış Uca Parellel (Standart)
Parallel to Peripheral Insert (Standard)
Стандартное – параллельно гнезду с внешней стороны пластины

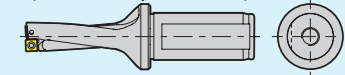

Dış Uca 90° Açılı
90° angle to peripheral insert
Угол 90° к периферийной вставке

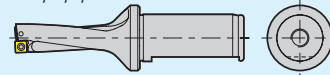

Dış Uca 150° Açılı
150° angle to peripheral insert
Угол 150° к периферийной вставке

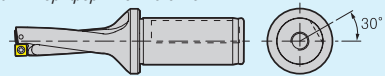

Dış Uca 180° Açılı
180° angle to peripheral insert
Угол 180° к периферийной вставке

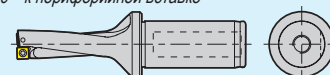

• Not / Note / Примечание :

- Şu Anki Kullanılan Takım / Currently Using Tool
Инструменты, которые используются в настоящее время
- Şu Anki Kesme Durumu / Current Cutting Condition
Режимы резания
- RPM ya da vc(m/min) / - RPM or vc(m/min)
- RPM или Vp(м/мин)
- vf(mm/min) ya da fn(mm/rev)
- vf(mm/min) or fn(mm/rev) or fn(mm/min) or fn(mm/Umdr.)
- Kesme Derinliği / Depth of Cut(mm)
- Глубина резания (мм)
- Ölçülen Standart Takım Ömrü / Standard of Measuring Tool Life
Стандартный срок службы инструмента
- Şu Anki Kullanılan Makinalar / Currently Using Machine
Станок, который используется в настоящее время
- İşleme Merkezi / Machining Center
- Обрабатывающий центр
- Genel Torna / General Lathe
- Общий токарный станок
- CNC Torna / CNC Lathe
- Станок с ЧПУ



*konusulan
the spoken kalite...
quality...*

EKONOMİK KESİCİLER

EKONOMİK KESİCİLER

MULTI FUNCTIONAL CUTTING TOOLS

МНОГОФУНКЦИОНАЛЬНЫЙ MULTI TOOL





AKKO **A** **EK** **R** - **D2.25** x **20**

X **C** **.** **.** **10** **T3** **04**

2 Kesiş Stili / Cutter Style / Тип режущего инструмента

EK : Ekonomik Kesici / Economic Cutting
Экономичное точение

3 Kesme Yönü / Cutting Direction / Направление резания

11 Kalınlık / Thickness / Толщина

01 s=1.59
T1 s=1.98
02 s=2.38
T2 s=2.78
03 s=3.18
T3 s=3.97
04 s=4.76
05 s=5.56
06 s=6.35
07 s=7.94
09 s=9.52

4 Delme Derinliği / Drilling Depth / Глубина сверления

5 Takım Çapı / Tool Diameter / Диаметр режущей части

6 Uç Şekli / Insert Form / Форма пластины

X **Q**

8 Toleranslar / Tolerance Classes / Точность

	IC	M	S
A	± 0.025	± 0.005	± 0.025
C	± 0.025	± 0.013	± 0.025
E	± 0.025	± 0.025	± 0.025
F	± 0.013	± 0.005	± 0.025
G	± 0.025	± 0.025	± 0.130
H	± 0.013	± 0.013	± 0.025
J	± 0.05-0.15	± 0.005	± 0.025
K	± 0.05-0.15	± 0.013	± 0.025
L	± 0.05-0.15	± 0.025	± 0.025
M	± 0.05-0.15	± 0.08-0.20	± 0.130
N	± 0.05-0.15	± 0.08-0.20	± 0.025
U	± 0.08-0.25	± 0.13-0.38	± 0.130

IC : Daire Ölçüsü / Inscribed Circle
M : Şekle Göre / Refer to Figure
S : Kalınlık / Thickness

9 Uç Tipi / Type of Insert / Форма отверстия

A **J** **T**
 $\beta = 70-90^\circ$ $\beta = 40-60^\circ$

B **M** **U**
 $\beta = 70-90^\circ$ $\beta = 40-60^\circ$

C **N** **W**
 $\beta = 70-90^\circ$ $\beta = 40-60^\circ$

F **Q** **X**
 $\beta = 40-60^\circ$ Special / Özel

G **R**

H
 $\beta = 70-90^\circ$

10 Kesme Kenar Uzunluğu / Cutting Edge Length / Длина режущей кромки

12 Köşe Konfigürasyonu / Corner Radius / Радиус при вершине

01 RE=0.1 12 RE=1.2
02 RE=0.2 16 RE=1.6
04 RE=0.4 24 RE=2.4
08 RE=0.8

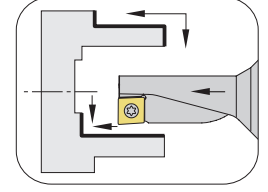
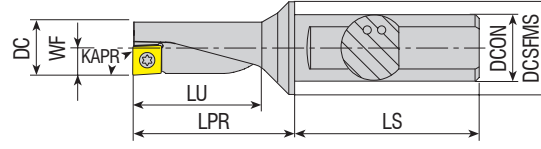

Takım Kodu Ordering Code Код для заказа	Stok Stock Наличие		Takım Ölçüleri (mm) Dimension (mm) Размеры (мм)							Kesici Uç Insert Пластина	Yedek Parçaları / Spare Parts / Запасные части	
	R	L	DC	DCON	DCSFMS	LU	LPR	LS	WF	Sıkma Vidası Screw Зажимной винт	Tork Anahtar Torx Key Торх Ключ	
AEKR/L-D2.25X8 XC.. 040104	●	●	8	10	12	18	22	38	4	XC.. 040104	3006-M1.8x4	82-T06
AEKR/L-D2.25X10 XC.. 050204	●	●	10	12	16	22.5	27.5	42	5	XC.. 050204	3006-M2x4	82-T07
AEKR/L-D2.25X12 XC.. 060204	●	●	12	16	20	27	33	45	6	XC.. 060204	3007-M2.2x4.6	82-T08
AEKR/L-D2.25X14 XC.. 070304	●	●	14	16	20	31.5	38	45	7	XC.. 070304	3008-M2.5x6	82-T08
AEKR/L-D2.25X16 XC.. 080304	●	●	16	20	25	36	44	50	8	XC.. 080304	3008-M3x6	80-T15
AEKR/L-D2.25X18 XC.. 09T304	●	●	18	25	32	40.5	53.5	56	9	XC.. 09T304	4015-M3.5x9	80-T20
AEKR/L-D2.25X20 XC.. 10T304	●	●	20	25	32	45	55	56	10	XC.. 10T304	4020-M4.5x10	
AEKR/L-D2.25X25 XC.. 130404	●	●	25	32	40	56.5	69	60	12.5	XC.. 130404	4020-M4.5x12	
AEKR/L-D2.25X32 XC.. 170504	●	●	32	32	50	72	88	60	16	XC.. 170504		

R: Sağ / Right / Правый L: Sol / Left / Левый
 ● Stokta / In Stock / В наличии ○ Stokta Yok / Non Stock Item / Нет в наличии
 CRTZT-ISCR-TGTC-KRLY Ucuna Uygunudur. / Compatible with CRTZT-ISCR-TGTC-KRLY Insert.
 Под пластину CRTZT-ISCR-TGTC-KRLY

Sipariş Örneği/Ordering Example/Образец заказа
 1 ad./pcs./шт. AEKR-D2.25X8 XC.. 040104

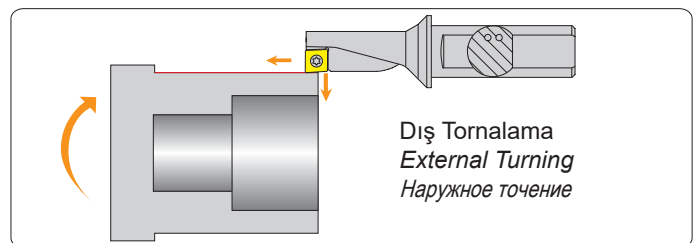
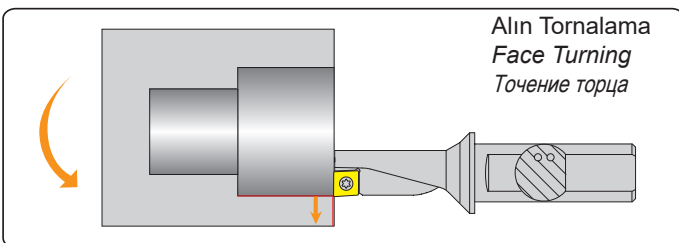
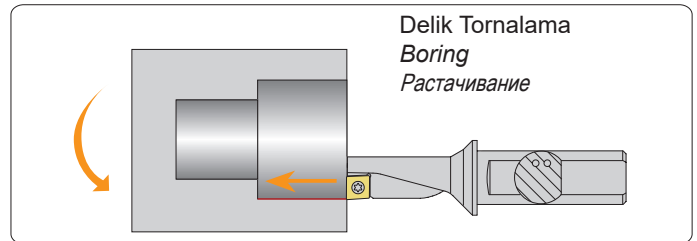
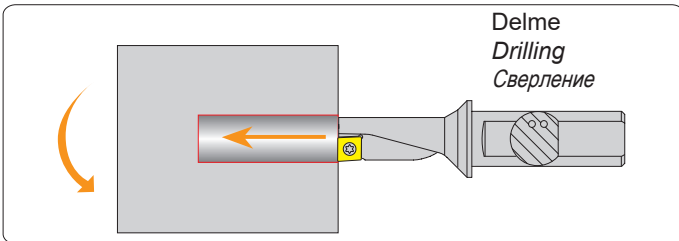
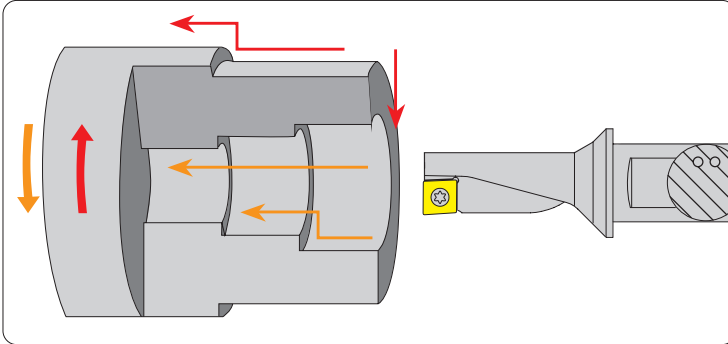

BARALAR

AYARLI DELİK İŞLEME BARALARI
ADJUSTABLE BORING HEADS
РЕГУЛИРУЕМЫЕ РАСТОЧНЫЕ ГОЛОВКИ

*konusulan
the spoken kalite...
quality...*

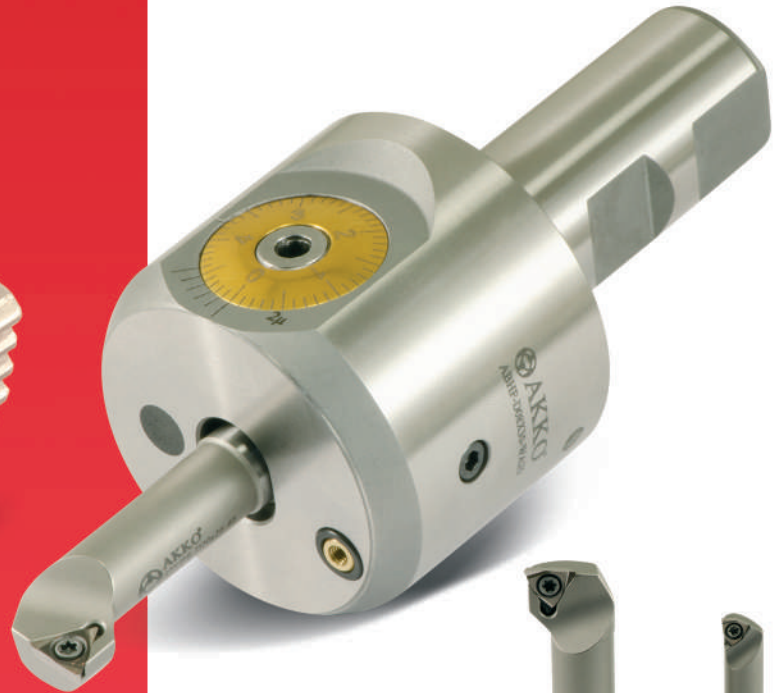
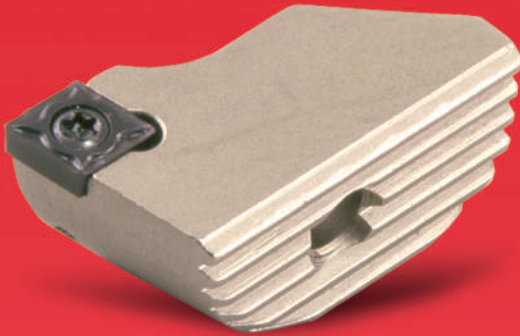

AKKO **A** **BH** **R** - **D18x22**

W16 - **L90** - **CC06**

2 Kesiş Stili / Cutter Style / Тип режущего инструмента

BH : Delik İşleme / Boring Head
Расточная головка

3 İşlem Tipi / Cutter Type / Виды растачивания

R : Kaba Baralama / Rough Boring
Черновое точение
F : Hassas Baralama / Fine Boring
Чистовое точение

5 Montaj Formu / Assembly Form / Тип хвостовика

W : Weldon

4 Ölçü Aralığı / Boring Range / Диаметр растачивания

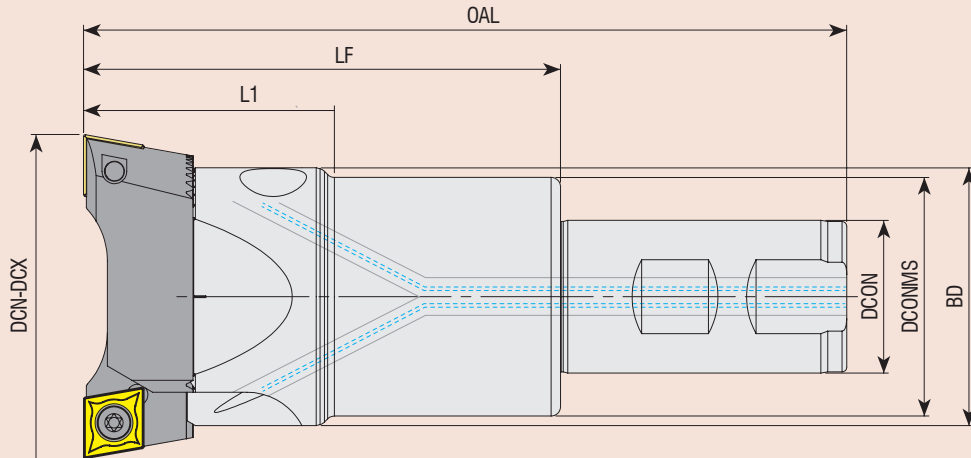

6 Takım Boyu / Tool Length / Длина инструмента

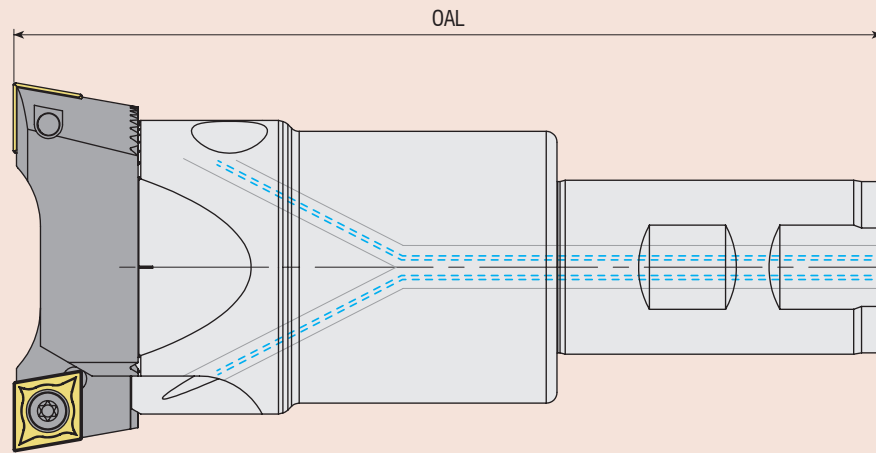

7 Kesici Uç / Insert / Пластина

CC06 : CC.. 0602..
CC09 : CC.. 09T3..
CC12 : CC.. 1204..

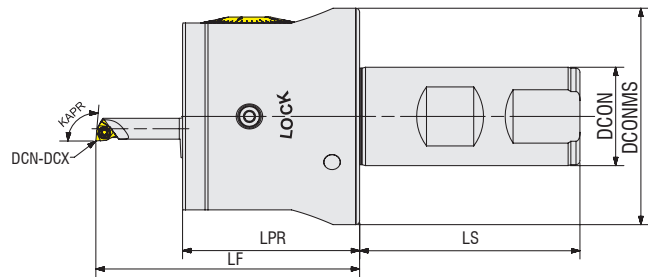

Takım Kodu Ordering Code Код для заказа	Stok Stock Наличие	Ölçü Aralığı Boring Range Диаметр DCN-DCX	Takım Ölçüleri (mm) Dimension (mm) Размеры (мм)							Kartuş Cartridge Картридж	Kesici Uç Insert Пластина	Bara Gövde Takım Kodu Boring Head Body Code Корпус расточной головки	
			LF	LPR	LS	DCON	DCONMS	KAPR	DCN				DCX
SET-ABHF-D06X30-WA25	●	06-30	85	45	56	25	55	95°	6	10	SWLCR-D06X10-22	WCGT020104L	ABHF-D06X30-WA25
									8	14	SWLCR-D08X14-30		
									12	18	STUPR-D12X18-40		
									16	22	STUPR-D16X22-40		
									20	26	STUPR-D20X26-40		
SET-ABHF-D29X40-WA16	○	29-40	50	46	40	16	27	93°	24	30	STUPR-D24X30-50	TPGX 090202L	ABHF-D29X40-WA16
									29	35	STFPR-D29x35		
SET-ABHF-D39X54-WA20	○	39-54	60	55	50	20	36		34	40	STFPR-D34x40		ABHF-D39X54-WA20
SET-ABHF-D52X80-WA25	○	52-80	70	65	56	25	48	93°	39	47	STFPR-D39x47		ABHF-D52X80-WA25
									46	54	STFPR-D46x54		
SET-ABHF-D78X170-WA32	○	78-116	83	77	60	32	70	93°	52	68	STFPR-D52x68		ABHF-D78X170-WA32
									64	80	STFPR-D64x80		
									78	98	STFPR-D78x98		
									96	116	STFPR-D96x116		

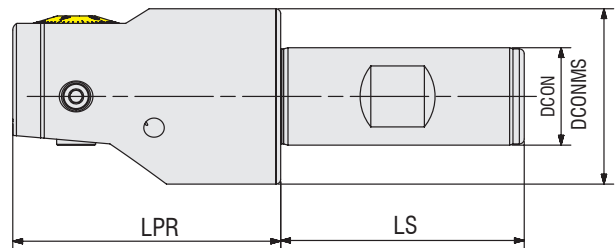

Takım Kodu Ordering Code Код для заказа	Stok Stock Наличие	Ölçü Aralığı Boring Range Диаметр DCN-DCX	Takım Ölçüleri (mm) Dimension (mm) Размеры (мм)				Yedek Parçaları / Spare Parts / Запасные части	
			LPR	LS	DCON	DCONMS	Anahtar Allen Key Ключ	
ABHF-D06X30-WA25	●	06-30	45	56	25	55	AAL-05-4	
ABHF-D29X40-WA16	○	29-40	46	40	16	27	AAL-01-2	AAL-02-2.5
ABHF-D39X54-WA20	○	39-54	55	50	20	36	AAL-02-2.5	AAL-03-3
ABHF-D52X80-WA25	○	52-80	65	56	25	48	AAL-05-4	AAL-07-5
ABHF-D78X170-WA32	○	78-170	77	60	32	72	AAL-07-5	AAL-08-6

● Stokta / In Stock / В наличии ○ Stokta Yok / Non Stock Item / Нет в наличии
Siparişte, gövde ve kartuş set olarak verilecektir. / When ordered, body and cartridge will be sent as set.
Картриджи поставляются в комплекте

Sipariş Örneği/Ordering Example/Образец заказа
1 ad./pcs./шт. SET-06X30-ABHF-D06X30-WA25

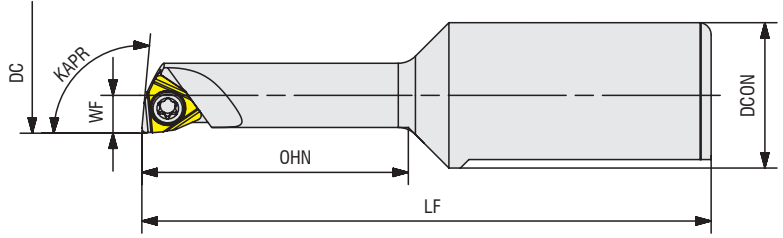

Takım Kodu Ordering Code Код для заказа	Stok Stock Наличие	Takım Ölçüleri (mm) Dimension (mm) Размеры (мм)						Kesici Uç Insert Пластина	Yedek Parçaları / Spare Parts / Запасные части		
		DC	WF	KAPR	LF	OHN	DCON		Sıkma Vidası Screw Зажимной винт	Tork Anahtar Torx Key Торк Ключ	
SWLCR-D06X10-22	●	6	3	95°	47	22	12	WCGT020104L	3006-M2x3.3	82-T06	
SWLCR-D08X14-30	●	8	4		55	30					

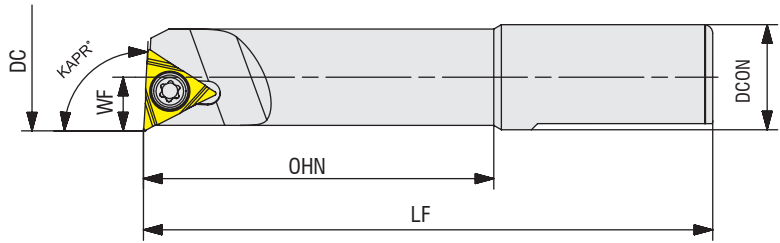

Takım Kodu Ordering Code Код для заказа	Stok Stock Наличие	Takım Ölçüleri (mm) Dimension (mm) Размеры (мм)						Kesici Uç Insert Пластина	Yedek Parçaları / Spare Parts / Запасные части		
		DC	WF	KAPR	LF	OHN	DCON		Sıkma Vidası Screw Зажимной винт	Tork Anahtar Torx Key Торк Ключ	
STUPR-D12X18-40	●	12	6	93°	65	40	12	TPGX 090202L	4008-M2.5x4.5	82-T08	
STUPR-D16X22-40	●	16	8		65	40			4008-M2.5x6		
STUPR-D20X26-40	●	20	10		75	50					
STUPR-D24X30-50	●	24	12		75	50					

● Stokta / In Stock / В наличии ○ Stokta Yok / Non Stock Item / Нет в наличии
Siparişte, gövde ve kartuş set olarak verilecektir. / When ordered, body and cartridge will be sent as set.
Картриджи поставляются в комплекте

Sipariş Örneği/Ordering Example/Образец заказа
1 ad./pcs./шт. SWLCR-D06X10-22

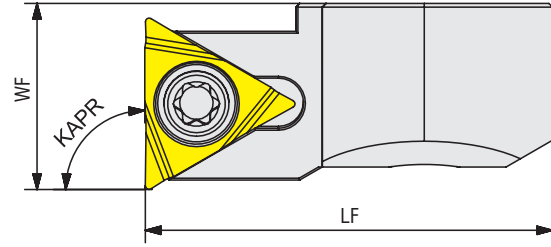
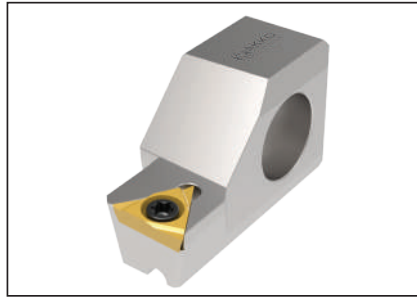

Takım Kodu Ordering Code Код для заказа	Stok Stock Наличие	Takım Ölçüleri (mm) Dimension (mm) Размеры (мм)			Kesici Uç Insert Пластина	Yedek Parçaları / Spare Parts / Запасные части	
		WF	KAPR	LF		Sıkma Vidası Screw Зажимной винт	Tork Anahtar Torx Key Торх Ключ
STFPR-D29x35	●	10	90°	21.90	TPGX 090202L	4008-M2.5x6	82-T08
STFPR-D34x40	●	12.50		21.90			
STFPR-D39x47	●	12		26.90			
STFPR-D46x54	●	15.50		26.90			
STFPR-D52x68	●	14		34.90			
STFPR-D64x80	●	20		34.90			
STFPR-D78x98	●	20		44.90			
STFPR-D96x116	●	29		44.90			

HASSAS BARA UZATMA ADAPTÖRÜ
EXTENSION FOR FINE BORING TOOLS
КАРТРИДЖИ ДЛЯ ЧИСТОВЫХ РАСТОЧНЫХ ГОЛОВОК

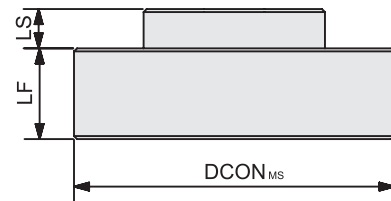
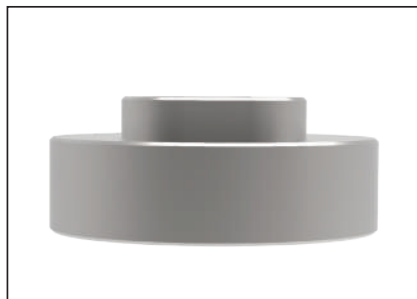

Takım Kodu Ordering Code Код для заказа	Stok Stock Наличие	Takım Ölçüleri (mm) Dimension (mm) Размеры (мм)		
		DCON	LF	LS
AEA-114x134	●	31.80	12.90	9
AEA-132x152	●	31.80	21.90	18

● Stokta / In Stock / Auf Lager ○ Stokta Yok / Non Stock Item / Kein Lagerartikel, Lieferzeit auf Anfrage
Siparişte, gövde ve kartuş set olarak verilecektir. / When ordered, body and cartridge will be sent as set.
Картриджи поставляются в комплекте

Sipariş Örneği/Ordering Example/Образец заказа
1 ad./pcs./шт. STFPR-D29x35

Kartuşların Montajı / Assembling Boring Bar / Установка картриджей

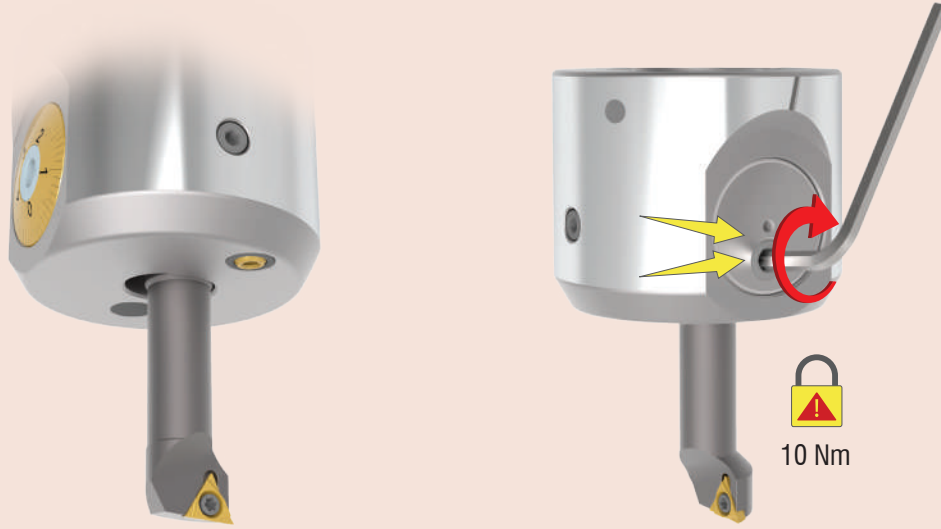

Çap Ayarı / Diameter Adjustment / Настройки диаметра

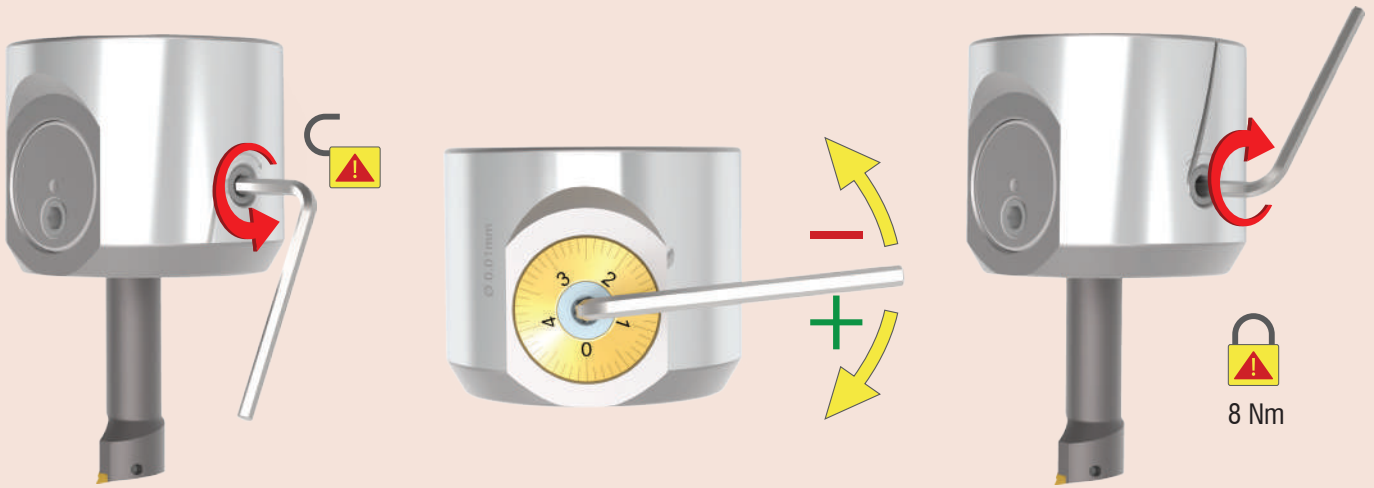

Ölçek / Scale - Vernier / Шкала

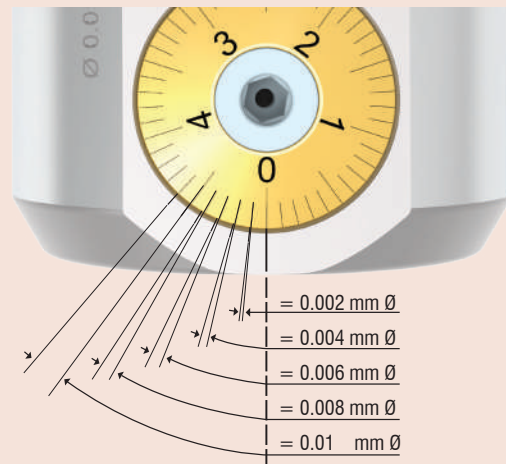
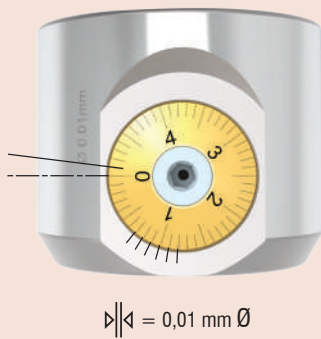

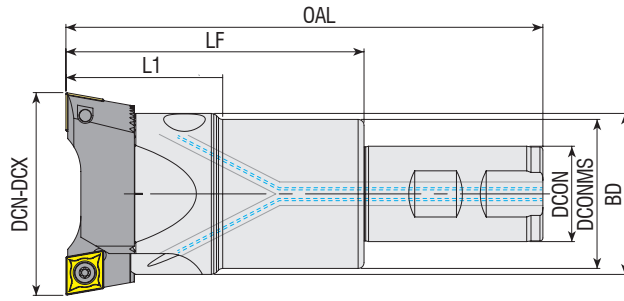

DIN 1835

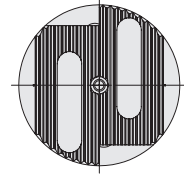

Takım Kodu
Ordering Code
Код для заказа

Stok
Stock
Наличие

Takım Ölçüleri (mm)
Dimension (mm)
Размеры (мм)

Kartuş
Cartridge
Картридж

Bara Gövde Takım Kodu
Boring Head Body Code
Корпус расточной головки

	Ölçü Aralığı Boring Range Диаметр DCN-DCX	DCON	DCONMS	BD	OAL	LF	L1		
ABHR-D18x22-W16-L90-CC06	● 18-22	16	-	-	90	42	-	AK.. 18-22	ABHRS-D16x42-W16-L90
ABHR-D18x22-W16-L150-CC06	● 18-22	16	-	-	150	102	-		ABHRS-D16x102-W16-L150
ABHR-D18x22-W16-L200-CC06	● 18-22	16	-	-	200	152	-		ABHRS-D16x152-W16-L200
ABHR-D22x28-W20-L100-CC06	● 22-28	20	-	-	100	50	-	AK.. 22-28	ABHRS-D20x50-W20-L100
ABHR-D22x28-W20-L150-CC06	● 22-28	20	-	-	150	100	-		ABHRS-D20x100-W20-L150
ABHR-D22x28-W20-L200-CC06	● 22-28	20	-	-	200	150	-		ABHRS-D20x150-W20-L200
ABHR-D28x38-W20-L110-CC06	● 28-38	20	25	-	110	60	-	AK.. 28-38	ABHRS-D25x60-W20-L110
ABHR-D28x38-W20-L160-CC06	● 28-38	20	25	-	160	110	-		ABHRS-D25x110-W20-L160
ABHR-D28x38-W20-L230-CC06	● 28-38	20	25	-	230	180	-		ABHRS-D25x180-W20-L230
ABHR-D36x50-W25-L120-CC06	● 36-50	25	32	-	120	64	-	AK.. 36-50	ABHRS-D32x64-W25-L120
ABHR-D36x50-W25-L170-CC06	● 36-50	25	32	-	170	114	-		ABHRS-D32x114-W25-L170
ABHR-D36x50-W25-L250-CC06	● 36-50	25	32	-	250	194	-		ABHRS-D32x194-W25-L250
ABHR-D36x50-W25-L120-CC09	● 36-50	25	32	-	120	64	-	AK.. 36-50-09	ABHRS-D32x64-W25-L120
ABHR-D36x50-W25-L170-CC09	● 36-50	25	32	-	170	114	-		ABHRS-D32x114-W25-L170
ABHR-D36x50-W25-L250-CC09	● 36-50	25	32	-	250	194	-		ABHRS-D32x194-W25-L250
ABHR-D50x68-W32-L140-CC09	● 50-68	32	40	-	140	80	-	AK.. 50-68	ABHRS-D40x80-W32-L140
ABHR-D50x68-W32-L200-CC09	● 50-68	32	40	-	200	140	-		ABHRS-D40x140-W32-L200
ABHR-D50x68-W32-L280-CC09	● 50-68	32	40	-	280	220	-		ABHRS-D40x220-W32-L280
ABHR-D50x68-W32-L140-CC12	● 50-68	32	40	-	140	80	-	AK.. 50-68-12	ABHRS-D40x80-W32-L140
ABHR-D50x68-W32-L200-CC12	● 50-68	32	40	-	200	140	-		ABHRS-D40x140-W32-L200
ABHR-D50x68-W32-L280-CC12	● 50-68	32	40	-	280	220	-		ABHRS-D40x220-W32-L280
ABHR-D68x90-W32-L160-CC12	● 68-90	32	50	54	160	100	50	AK.. 68-90	ABHRS-D50x100-W32-L160
ABHR-D68x90-W32-L210-CC12	● 68-90	32	50	54	210	150	50		ABHRS-D50x150-W32-L210
ABHR-D68x90-W32-L280-CC12	● 68-90	32	50	54	280	220	50		ABHRS-D50x220-W32-L280
ABHR-D90x120-W32-L140-CC12	● 90-120	32	63	72	140	80	63	AK.. 90-120	ABHRS-D63x80-W32-L140
ABHR-D90x120-W40-L200-CC12	● 90-120	40	63	72	200	130	63		ABHRS-D63x130-W40-L200
ABHR-D90x120-W40-L300-CC12	● 90-120	40	63	72	300	230	63		ABHRS-D63x230-W40-L300
ABHR-D120x160-W40-L210-CC12	● 120-160	40	80	95	210	140	75	AK.. 120-160	ABHRS-D80x140-W40-L210
ABHR-D120x160-W40-L300-CC12	● 120-160	40	80	95	300	230	75		ABHRS-D80x230-W40-L300
ABHR-D160x200-W40-L210-B-CC12	● 160-200	40	80	95	210	140	75	AK.. 160-200	ABHRS-D80x140-W40-L210
ABHR-D160x200-W40-L300-B-CC12	● 160-200	40	80	95	300	230	75		ABHRS-D80x230-W40-L300

● Stokta / In Stock / В наличии ○ Stokta Yok / Non Stock Item / Нет в наличии
Siparişte, gövde ve kartuş set olarak verilecektir. / When ordered, body and cartridge will be sent as set.
Картриджи поставляются в комплекте

Sipariş Örneği/Ordering Example/Образец заказа
1 ad./pcs./шт. ABHR-D18x22-W16-L90-CC06

AYARLI KABA DELİK İŞLEME BARA GÖVDESİ
ADJUSTABLE ROUGH BORING HEADS BODY
КОРПУС РЕГУЛИРУЕМОЙ РАСТОЧНОЙ ГОЛОВКИ ДЛЯ ЧЕРНОВОГО ТОЧЕНИЯ

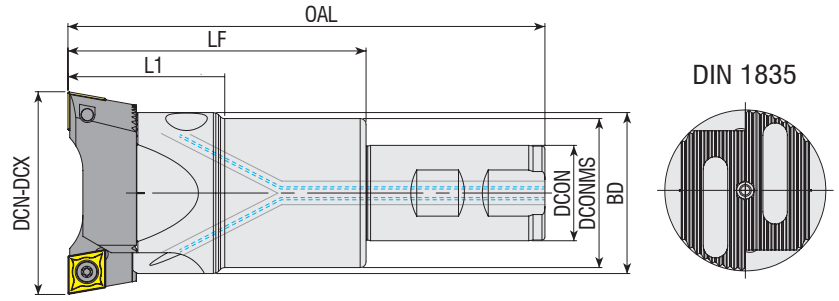

Takım Kodu Ordering Code Код для заказа	Stok Stock Наличие	Ölçü Aralığı Boring Range Диаметр DCN-DCX	Takım Ölçüleri (mm) Dimension (mm) Размеры (мм)					Yedek Parçaları / Spare Parts / Запасные части					
			DCON	DCONMS	BD	OAL	LF	L1	Montaj Vidası Mounting Screw Монтажный винт	Montaj Vida Anahtarı Mounting Screw Key Ключ	Pabuç Clamp Ползун	Ayar Vidası Adjusting Screw Регулирующий винт	Ayar Vida Anahtarı Allen Key Ключ
ABHRS-D16x42-W16-L90	●	18-22	16	-	-	90	42	-					
ABHRS-D16x102-W16-L150	●	18-22	16	-	-	150	102	-	2525-M3x14	AAL-02-2.5	ABKS-D16	2715-M3x4	
ABHRS-D16x152-W16-L200	●	18-22	16	-	-	200	152	-					
ABHRS-D20x50-W20-L100	●	22-28	20	-	-	100	50	-					
ABHRS-D20x100-W20-L150	●	22-28	20	-	-	150	100	-	2503-M4x15	AAL-03-3	ABKS-D20	2715-M3x5	AAL-09-1.5
ABHRS-D20x150-W20-L200	●	22-28	20	-	-	200	150	-					
ABHRS-D25x60-W20-L110	●	28-38	20	25	-	110	60	-					
ABHRS-D25x110-W20-L160	●	28-38	20	25	-	160	110	-	2503-M4x20	AAL-03-3	ABKS-D25	2715-M3x8	
ABHRS-D25x180-W20-L230	●	28-38	20	25	-	230	180	-					
ABHRS-D32X64-W25-L120	●	36-50	25	32	-	120	64	-					
ABHRS-D32X114-W25-L170	●	36-50	25	32	-	170	114	-	2504-M5x25	AAL-05-4	ABKS-D32	2702-M4x12	AAL-01-2
ABHRS-D32X194-W25-L250	●	36-50	25	32	-	250	194	-					
ABHRS-D40x80-W32-L140	●	50-68	32	40	-	140	80	-					
ABHRS-D40x140-W32-L200	●	50-68	32	40	-	200	140	-	2505-M6x30	AAL-07-5	ABKS-D40	2725-M5x16	
ABHRS-D40x220-W32-L280	●	50-68	32	40	-	280	220	-					AAL-02-2.5
ABHRS-D50x100-W32-L160	●	68-90	32	50	54	160	100	50					
ABHRS-D50x150-W32-L210	●	68-90	32	50	54	210	150	50	2506-M8x35	AAL-08-6	ABKS-D50	2725-M5x12	
ABHRS-D50x220-W32-L280	●	68-90	32	50	54	280	220	50					
ABHRS-D63x80-W32-L140	●	90-120	32	63	72	140	80	63					
ABHRS-D63x130-W40-L200	●	90-120	40	63	72	200	130	63	2508-M10x40	AAL-11-8	ABKS-D63	2703-M6x16	AAL-03-3
ABHRS-D63x230-W40-L300	●	90-120	40	63	72	300	230	63					
ABHRS-D80x140-W40-L210	●	120-160	40	80	95	210	140	75	2510-M12x40	AAL-12-10	ABKS-D80	2704-M8x25	AAL-05-4
ABHRS-D80x230-W40-L300	●	120-160	40	80	95	300	230	75					
ABHRS-D80x140-W40-L210	●	160-200	40	80	95	210	140	75					
ABHRS-D80x230-W40-L300	●	160-200	40	80	95	300	230	75					

R: Sağ / Right / Правый L: Sol / Left / Левый
● Stokta / In Stock / В наличии ○ Stokta Yok / Non Stock Item / Нет в наличии

Sipariş Örneği/Ordering Example/Образец заказа
1 ad./pcs./шт. ABHRS-D16x42-W16-L90

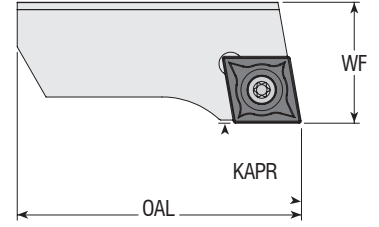

Takım Kodu Ordering Code Код для заказа	Stok Stock Наличие	Takım Ölçüleri (mm) Dimension (mm) Размеры (мм)		Kesici Uç Insert Пластина	Yedek Parçaları / Spare Parts / Запасные части		
		Ölçü Aralığı Boring Range	WF		OAL	Sıkma Vidası Screw Зажимной винт	Tork Anahtar Torx Key Торх Ключ
AKSR 18-22	●	18-22	9	15	CC.T 0602..	4008-M2.5x6	82-T08
AKSR 22-28	●	22-28	10	19			
AKSR 28-38	●	28-38	13	23			
AKSR 36-50	●	36-50	16	32	CC.T 09T3..	4015-M3.5x8	80-T15
AKSR 36-50-09	●	36-50	16	32			
AKSR 50-68	●	50-68	20	40			
AKSR 50-68-12	●	50-68	20	40	CC.T 1204..	1020-M5x11	80-T20
AKSR 68-90	●	68-90	23	54			
AKSR 90-120	●	90-120	28	70			
AKSR 120-160	●	120-160	32	95			
AKSR 160-200	●	160-200	32	120			

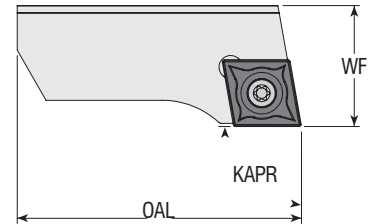

Takım Kodu Ordering Code Код для заказа	Stok Stock Наличие	Takım Ölçüleri (mm) Dimension (mm) Размеры (мм)		Kesici Uç Insert Пластина	Yedek Parçaları / Spare Parts / Запасные части		
		Ölçü Aralığı Boring Range	WF		OAL	Sıkma Vidası Screw Зажимной винт	Tork Anahtar Torx Key Торх Ключ
AKCR 28-38	●	28-38	12.8	23	CC.T 0602..	4008-M2.5x6	82-T08
AKCR 36-50	●	36-50	15.8	32			
AKCR 36-50-09	●	36-50	15.8	32			
AKCR 50-68	●	50-68	19.7	40	CC.T 09T3..	4015-M3.5x8	80-T15
AKCR 50-68-12	●	50-68	19.7	40			
AKCR 68-90	●	68-90	22.7	54			
AKCR 90-120	●	90-120	27.7	70	CC.T 1204..	1020-M5x11	80-T20
AKCR 120-160	●	120-160	31.7	95			
AKCR 160-200	●	160-200	31.7	120			

R: Sağ / Right / Правый L: Sol / Left / Левый

● Stokta / In Stock / В наличии ○ Stokta Yok / Non Stock Item / Нет в наличии
ISO Ucuna Uygunudur. / Compatible with ISO Insert. / Под пластину ISO.

Sipariş Örneği/Ordering Example/Образец заказа
1 ad./pcs./шт. AKSR 18-22

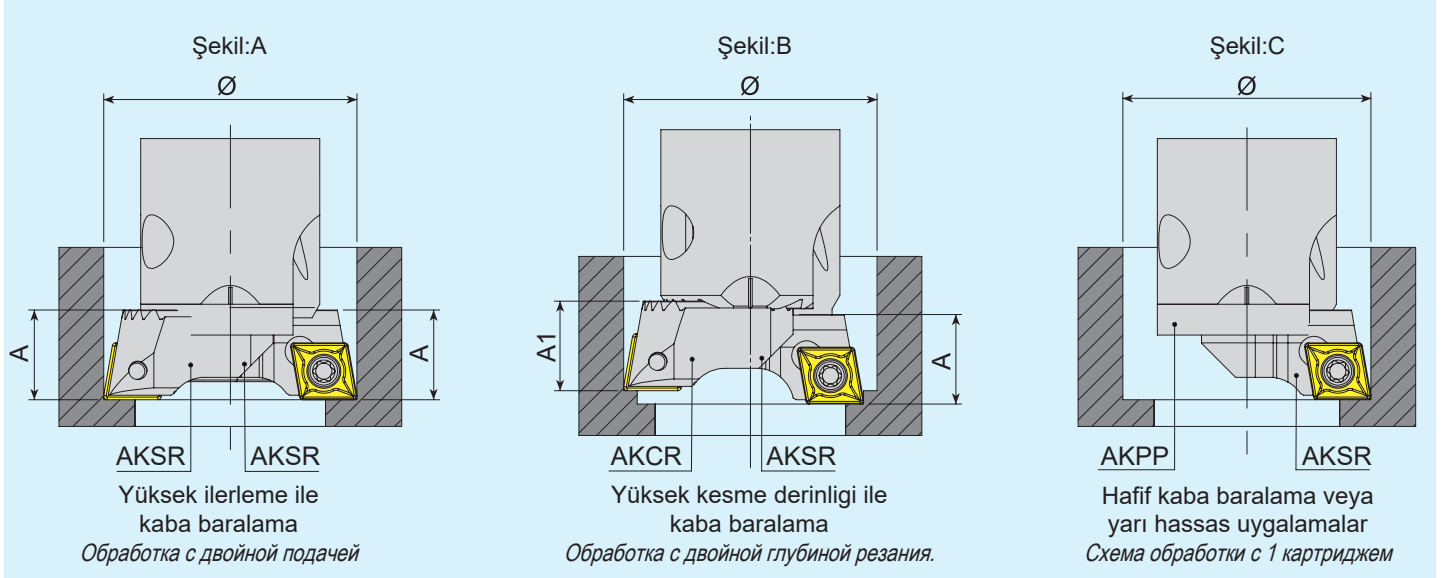

1. Kesici kenarların radyal ayarı, takım ölçme ekipmanı ile yapılmalıdır.
2. İki uçlu baralama takımı, ağır talaş kaldırma işlemini içeren kaba baralama işlemleri içindir. Çift uçlu baralama takımı ile:
 - Yüksek ilerleme oranında kaba baralama işlemleri için, aynı düzlemdeki iki AKSR kartuşu, aynı radyal mesafeye ayarlanır. (Şekil A)
 - Aynı düzlemde olmayan bir AKCR kartuşu ve bir AKSR kartuşu yüksek derinlikte kaba baralama işlemleri için kullanılır. (Şekil B)
 - i. Kaba baralama işleminde, alınacak paso miktarı tam olarak ikiye bölünüp, düzgün bir kesim sağlanmış olur, ancak bu durumda tur başına ilerleme tek ağız olarak hesaplanmalıdır. ($f=f1$)
 - ii. Hassas baralama işleminde, alınacak paso miktarı AKSR kartuş için ara kaba olarak ve AKCR kartuş için hassas bara olarak çaplar ayarlanır ve bu sayede bazı ara kaba işleme ihtiyaç kalmaz.
3. Tek kartuşlu baralama takımları, normal talaş kaldırma işlemini içeren kaba ve hassas baralama işlemleri içindir. Dişleri koruma plakası, AKPP daima kullanılmalıdır. (Şekil C)

1. Radial setting of the cutting edges should be carried out with tool presetting equipment.
2. Boring bars fitted with two insert pockets are for roughing operations involving heavy chip removal. The double-insert boring bars include:
 - Two AKSR cartridges on the same plane with two cutting edges set at identical radial distance for high feed rate roughing operations. (fig. A)
 - An AKCR cartridge and an AKSR cartridge not on the same plane for high-depth roughing operations. (fig. B)
 - i. With the rough boring operation, this allows double the cutting width, using only a single feed rate. ($f=f1$)
 - ii. With the finish boring operation, the cutting width is divided so that some of the intermediate machining can be omitted.
3. Boring bars fitted with a single cartridge are for roughing and finishing operations involving normal chip removal. The serrated surface protection plate AKPP should always be used (fig. C)

1. Радиальная установка резцов должна быть выполнена на приборе по предварительной настройке инструмента вне станка.
2. Двурезцовые расточные головки предназначены для высокопроизводительной черновой обработки. Три схемы сборки:
 - Рисунок А: два картриджа AKSR... устанавливаются в одной плоскости на один диаметр. Это обеспечивает двойную подачу при черновой обработке.
 - Рисунок В: 2 различных картриджа AKSR... и AKCR... устанавливаются с разными вылетами. Это обеспечивает двойную глубину резания.
 - i. Подача устанавливается одна и должна быть не более разницы вылетов А и А1.
 - ii. Распределение припуска по картриджам должно быть равномерным.
 - 3. Рисунок С: используется один из картриджей AKSR... или AKCR..., а так же заглушка AKPP....



*konusulan
the spoken kalite...
quality...*

FREZELEME TAKIMLARI
MILLING TOOLS
ФРЕЗЕРНЫЙ ИНСТРУМЕНТ



AKKO **A** **EM** **90** **L** - **A** **P** **10**

1 2 3 4 5 6 7

D12 - **W16** - **L100** - **Z01** - **H**

8 9 10 11 12

2 Kesiş Stili / Cutter Style / Тип режущего инструмента

FM: Yüzey Frezeleme Takımları / Face Milling Tools / Торцевые Фрезы
EM: Alın ve Yüzey Parmak Frezeleri / End Face Milling Tools / Торцевые Фрезы
CM: Pah Kırma Parmak Frezeleri / Chamfering End Milling Tools / Концевые Спиральные Фрезы Для Снятия Фаски
HM: Helis Parmak Frezeleri / Helix End Milling Tools / Концевые Фрезы Для Снятия Фаски
TSM: T Kanal Frezeleri / T Slot Milling Tools / Т-Образные Фрезы
HFM: Yüksek İlerleme Frezeleme Takımları / High Feed Milling Tools / Высокопроизводительные Концевые Фрезы
PMR: Küresel Uçlu Parmak Frezeleri / Ball Nose End Milling Tools / Сферические Концевые Фрезы
SDM: Disk Frezeler / Slot Disc Milling / Дисковые Трехсторонние Фрезы
CBM: Silindirik Alyan Başlı Vida Havşalarını Açma Frezeleri / Countersink Milling Tool for Cylindrical Allen Head Screws
Зенковка Для Отверстий Под Винты С Цилиндрической И Шестигранной Головкой (Гост 974-1)

3 Freze Yanaşma Açısı / Lead Angle / Угол в плане

90° - 75° - 60° - 45°
20° - 15° - 11° - 5° - 0°

4 Freze Yanaşma Açısı / Lead Angle / Исполнение

L: Sol - Left / Links / Левая сторона
C: Baskı Pabuçu - Clamp / Прижим
S: Atlık - Shim / опорными пластинами
CL: Baskı Pabuçlu Sol Yön - Left Way with Clamp
Левое вращение, крепление СМП прихватом
CS: Baskı Pabuçlu Altlıklı - Clamp with Shim
Крепление СМП прихватом, с опорными пластинами
CSL: Baskı Pabuçlu Altlıklı Sol Yön - Left Way Clamp with Shim
Левое вращение, крепление СМП прихватом, с опорными пластинами

5 Uç Tipi / Type of Insert / Форма пластины

C	D	E	K
L	R	S	T
V	W	A	B
H	M	O	P

6 Serbest Uç Açısı / Clearance angle of Insert / Задний угол пластины

A	B	C
D	E	F
G	N	P

7 Kesme Kenar Uzunluğu / Cutting Edge Length / Длина режущей кромки

I	I
I	I
I	

8 Takım Çapı / Tool Diameter / Диаметр режущей части

9 Montaj Formu ve Çapı / Assembly Form and Diameter / Тип и диаметр хвостовика

A, B, C, D: ISO'ya göre montaj formu / Assembly Form and Diameter / Под ISO A, B, C, D Тип сборки
Silindirik Şaft / Cylindrical Shank / Zylindrischer Schaft
W: Weldon

10 Takım Boyu / Tool Length / Длина инструмента

11 Etkili Diş Adedi / Number of Effective Tooth / Количество эффективных зубцов

12 İçten Soğutmalı / With Coolant Hole / Канал для СОЖ

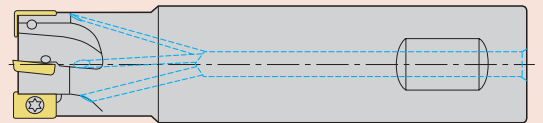

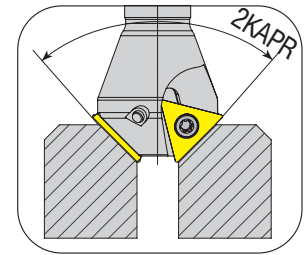
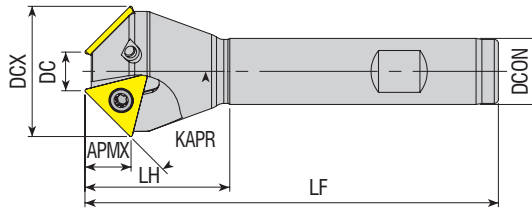

Takım Kodu Ordering Code Код для заказа	Stok Stock Наличие	Takım Ölçüleri (mm) Dimension (mm) Размеры (мм)								Kesici Uç Insert Пластина	Yedek Parçaları / Spare Parts / Запасные части				
		KAPR	DC	DCX	DCON	LF	LH	ZEFP	APMX		Sıkma Vidası Screw Зажимной винт	Tork Anahtar Torx Key Торх Ключ			
ACM10-TC16-D17X22-W16-L90-Z01	●	10°	17	22	16	90	30	1	15.2	TC.T 16T304					
ACM15-TC16-D17X24-W16-L90-Z01	●	15°	17	24	16	90	30	1	14.9						
ACM15-TC16-D22X29-W16-L100-Z01	●	15°	22	29	16	100	30	1	14.9						
ACM15-TC16-D30X37-W20-L100-Z02	●	15°	30	37	20	100	35	2	14.9						
ACM15-TC16-D35X42-W20-L100-Z03	●	15°	35	42	20	100	38	3	14.9						
ACM15-TC16-D52X59-W25-L110-Z03	●	15°	52	59	25	110	40	3	14.9						
ACM17.5-TC16-D17X25-W16-L90-Z01	●	17.5°	17	25	16	90	30	1	14.7						
ACM18.5-TC16-D21.3X30-W20-L100-Z02	●	18.5°	21.3	30	20	100	30	2	13.5				TC.T 16T308		
ACM20-TC16-D12X22-W16-L100-Z01	●	20°	12	22	16	100	30	1	14.4				TC.T 16T304	4015-M3.5x9	80-T15
ACM20-TC16-D17X27-W16-L100-Z01	●	20°	17	27	16	100	30	1	14.4						
ACM20-TC16-D23X33-W20-L100-Z02	●	20°	23	33	20	100	30	2	14.4						
ACM20-TC16-D28X38-W20-L100-Z02	●	20°	28	38	20	100	35	2	14.4						
ACM20-TC16-D35X45-W20-L100-Z03	●	20°	35	45	20	100	40	3	14.4						
ACM20-TC16-D39X49-W20-L100-Z03	●	20°	39	49	20	100	40	3	14.4						
ACM20-TC16-D45X55-W25-L110-Z03	●	20°	45	55	25	110	40	3	14.4						
ACM20-TC16-D51X61-W25-L110-Z03	●	20°	51	61	25	110	40	3	14.4						
ACM22.5-TC16-D17X28-W16-L100-Z01	●	22.5°	17	28	16	100	30	1	14.2						
ACM25-TC16-D17X29-W16-L100-Z01	●	25°	17	29	16	100	30	1	13.9						
ACM30-TC16-D6X20-W16-L100-Z01	●	30°	6	20	16	100	30	1	13.3	TC.T 090204	3007-M2.2x4.6	82-T07			
ACM30-TC16-D15X30-W16-L100-Z01	●	30°	15	30	16	100	30	1	13.3						
ACM30-TC16-D17.5X32.5-W20-L100-Z02	●	30°	17.5	32.5	20	100	30	2	13.3						
ACM30-TC16-D20X35-W16-L100-Z02	●	30°	20	35	16	100	35	2	13.3						
ACM30-TC16-D30X45-W20-L100-Z02	●	30°	30	45	20	100	40	2	13.3						
ACM30-TC16-D35X50-W20-L100-Z03	●	30°	35	50	20	100	40	3	13.3						
ACM30-TC16-D45X60-W25-L110-Z03	●	30°	45	60	25	110	40	3	13.3						
new ACM40-TC16-D18x37-W20-L100-Z02	●	40°	18	37	20	100	40	2	11.7						
ACM45-TC09-D7X18-W16-L100-Z02	●	45°	7	18	16	100	25	2	5.9				TC.T 110204	3008-M2.5x6	82-T08
ACM45-TC11-D11X24-W16-L100-Z02	●	45°	11	24	16	100	25	2	6.9				TC.T 16T304	4015-M3.5x9	80-T15
ACM45-TC16-D5X26-W16-L100-Z01	●	45°	5	26	16	100	30	1	10.8						
ACM45-TC16-D10X31-W16-L100-Z02	●	45°	10	31	16	100	35	2	10.8						
ACM45-TC16-D10X31-W20-L100-Z02	●	45°	10	31	20	100	35	2	10.8						
ACM45-TC16-D18X39-W16-L100-Z02	●	45°	18	39	16	100	40	2	10.8						
ACM45-TC16-D18X39-W20-L100-Z02	●	45°	18	39	20	100	40	2	10.8						
ACM45-TC16-D20X41-W20-L100-Z02	●	45°	20	41	20	100	40	2	10.8						
ACM45-TC16-D30X51-W20-L100-Z02	●	45°	30	51	20	100	40	2	10.8						
new ACM50-TC16-D16X39-W20-L100-Z03	●	50°	16	39	20	100	40	3	9.8						
ACM55-TC16-D16X40-W20-L100-Z03	●	55°	16	40	20	100	40	3	8.7						
ACM62-TC16-D14X40-W20-L100-Z03	●	62°	14	40	20	100	40	3	7.1						
ACM72-TC16-D14X42-W20-L100-Z03	●	72°	14	42	20	100	40	3	4.6						

R: Sağ / Right / Правый L: Sol / Left / Левый

● Stokta / In Stock / В наличии ○ Stokta Yok / Non Stock Item / Нет в наличии

ISO Ucuna Uygunudur. / Compatible with ISO Insert. / Под пластину ISO.

Sipariş Örneği/Ordering Example/Образец заказа

1 ad./pcs./шт. ACM10-TC16-D17X22-W16-L90-Z01

Kesme Hesabı : S 377/ Cutting Calculation : P 377 / Расчет режимов резания: стр. 377

➤ **S-SİSTEM PAH FREZELER**
S-SYSTEM CHAMFERING END MILLS
S-ТИП КОНЦЕВЫЕ ФРЕЗЫ ДЛЯ СНЯТИЯ ФАСКИ (ЗЕНКОВКИ)

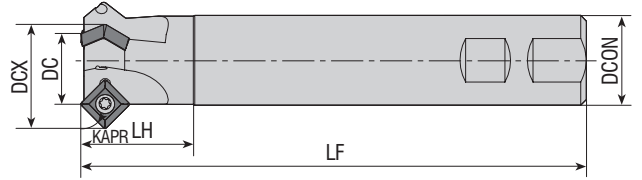

Takım Kodu Ordering Code Код для заказа	Stok Stock Наличие	Takım Ölçüleri (mm) Dimension (mm) Размеры (мм)								Kesici Uç Insert Пластина	Yedek Parçaları / Spare Parts / Запасные части	
		KAPR	DC	DCX	DCON	LF	LH	ZEFP	a		Sıkma Vidası Screw Зажимной винт	Tork Anahtar Torx Key Торх Ключ
ACM45-SP1104-D12x26-W20-L150-Z01	●	45°	12	26	20	150	30	1	-	SPGT 110408	4015-M4x9	80-T15
ACM45-SP1104-D25x39-W25-L150-Z02	●	45°	25	39	25	150	35	2	-			
ACM45-SP1104-D32x46-W32-L150-Z03	●	45°	32	46	32	150	40	3	-			

ZCC Ucuna Uygundur. / Compatible with ZCC Insert. / Под пластину ZCC

➤ **HELİS PAH FREZELEME TAKIMLARI**
HELIX CHAMFER MILLING TOOLS
КУКУРУЗНЫЕ ФРЕЗЫ ДЛЯ СНЯТИЯ ФАСКИ

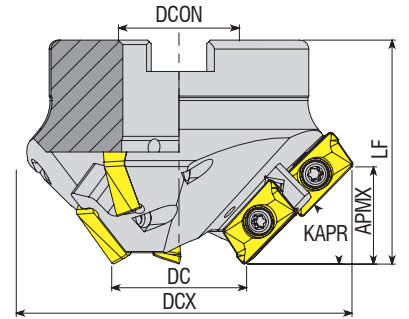

Takım Kodu Ordering Code Код для заказа	Stok Stock Наличие	Takım Ölçüleri (mm) Dimension (mm) Размеры (мм)								Kesici Uç Insert Пластина	Yedek Parçaları / Spare Parts / Запасные части	
		ZEFP		KAPR	DC	DCX	DCON	APMX	LF		Sıkma Vidası Screw Зажимной винт	Tork Anahtar Torx Key Торх Ключ
		Toplam Total Gesamt	Etkili Effective Effektiv									
AHM15-AP16-D35x93-A27-Z0306-H	●	6	3	15	35	93	27	8	50	AP. 1604..	4015-M4x11	80-T15
AHM30-AP16-D35x87-A27-Z0306-H	●	6	3	30	35	87	27	15	50			
AHM45-AP16-D35x77-A27-Z0306-H	●	6	3	45	35	77	27	21.5	50			
AHM60-AP16-D35x65-A22-Z0306-H	●	6	3	60	35	65	22	26.5	50			
AHM75-AP16-D35x50-A22-Z0306-H	●	6	3	75	35	50	22	29.5	50			

R: Sağ / Right / Правый L: Sol / Left / Левый
 ● Stokta / In Stock / В наличии ○ Stokta Yok / Non Stock Item / Нет в наличии
 ISO Ucuna Uygundur. / Compatible with ISO Insert. / Под пластину ISO.

Sipariş Örneği/Ordering Example/Образец заказа
 1 ad./pcs./шт. ACM45-SP1104-D12x26-W20-L150-Z01
 Kesme Hesabı : S 377/ Cutting Calculation : P 377 / Расчет режимов резания: стр. 377

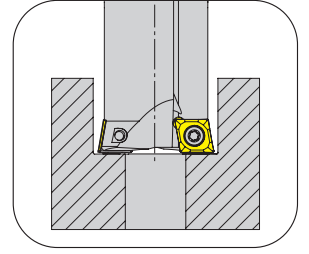
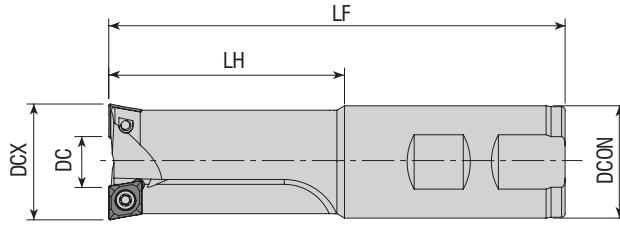

Takım Kodu
Ordering Code
 Код для заказа

Stok
 Stock
 Наличие

Takım Ölçüleri (mm)
 Dimension (mm)
 Размеры (мм)

Kesici Uç
 Insert
 Пластина

Yedek Parçaları / Spare Parts / Запасные части

Sıkma Vidası
 Screw
 Зажимной винт

Tork Anahtar
 Torx Key
 Торх Ключ

Takım Kodu Ordering Code Код для заказа	Stok Stock Наличие	DC	DCX	DCON	LH	LF	Kullanılan Vidalar For Screws Für Schraube	Kesici Uç Insert Пластина	Sıkma Vidası Screw Зажимной винт	Tork Anahtar Torx Key Торх Ключ
ACBM-CC06-D17X6-W16-L150-Z02	●	6	17	16	30	150	-	 CC.. 060204	 3008-M2.5x6	 82-T08
ACBM-CC06-D18X7-W16-L100-Z02-H	●	7	18	16	32	100	M10			
ACBM-CC06-D18X7-W16-L160-Z02-H	●	7	18	16	32	160	M10			
ACBM-CC06-D20X9-W20-L100-Z02-H	●	9	20	20	40	100	M12			
ACBM-CC06-D20X9-W20-L160-Z02-H	●	9	20	20	38	160	M12			
ACBM-CC09-D26X8.5-W25-L130-Z02-H	●	8.5	26	25	50	130	M16	 CC.. 09T304	 4015-M3.5x9	 80-T15
ACBM-CC09-D26X8.5-W25-L200-Z02-H	●	8.5	26	25	50	200	M16			
ACBM-CC09-D30X12.5-W32-L130-Z02-H	●	12.5	30	32	65	130	-			
ACBM-CC09-D33X15.5-W32-L130-Z02-H	●	15.5	33	32	65	130	M20			
ACBM-CC09-D33X15.5-W32-L200-Z02-H	●	15.5	33	32	65	200	M20			
ACBM-SP06-D15X4-W16-L160-Z02-H	●	4	15	16	80	160	M8	 SP. 060204	 3007-M2.2x4.6	 82-T07

R: Sağ / Right / Правый L: Sol / Left / Левый

● Stokta / In Stock / В наличии ○ Stokta Yok / Non Stock Item / Нет в наличии
 ISO Ucuna Uygunudur. / Compatible with ISO Insert. / Под пластину ISO.

Sipariş Örneği/Ordering Example/Образец заказа
 1 ad./pcs./шт. ACBM-CC06-D17X6-W16-L150-Z02

Kesme Hesabı : S 377/ Cutting Calculation : P 377 / Расчет режимов резания: стр. 377



S-SİSTEM YÜZEY PARMAK FREZELER

S-SYSTEM END MILLS

S-ТИП КОНЦЕВЫЕ ФРЕЗЫ

KAPR=90°

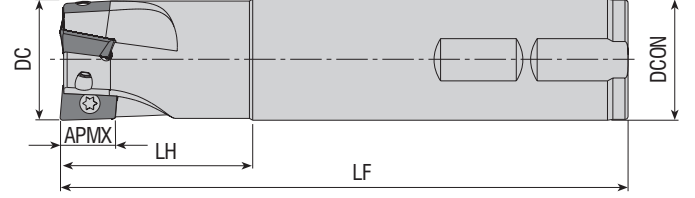

Takım Kodu Ordering Code Код для заказа	Stok Stock Наличие	Takım Ölçüleri (mm) Dimension (mm) Размеры (мм)						Kesici Uç Insert Пластина	Yedek Parçaları / Spare Parts / Запасные части				
		DC	ZEFP	DCON	LF	LH	APMX		Sıkma Vidası Screw Зажимной винт	Tork Anahtar Torx Key Торх Ключ			
AEM90-AD1505-D25-W25-L150-Z02	●	25	2	25	150	50	14.30						
AEM90-AD1505-D30-W25-L150-Z03	●	30	3	25	150	40	14.30				AD.. 1505..	4015-M4x9	80-T15
AEM90-AD1505-D32-W32-L150-Z03	●	32	3	32	150	50	14.30						

ISCR Ucuna Uygundur. / Compatible with ISCR Insert. / Под пластину ISCR

KAPR=90°

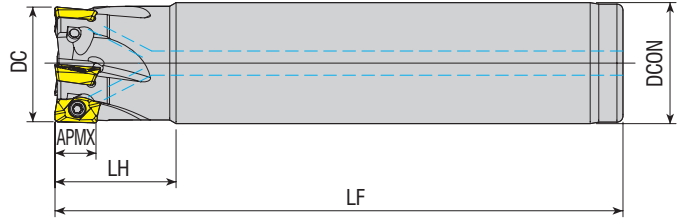

Takım Kodu Ordering Code Код для заказа	Stok Stock Наличие	Takım Ölçüleri (mm) Dimension (mm) Размеры (мм)						Kesici Uç Insert Пластина	Yedek Parçaları / Spare Parts / Запасные части		
		DC	ZEFP	DCON	LF	LH	APMX		Sıkma Vidası Screw Зажимной винт	Tork Anahtar Torx Key Торх Ключ	
AEM90-AD07-D10-C08-L90-Z02-H	●	10	2	8	90	16	6				
AEM90-AD07-D10-C10-L80-Z02-H	●	10	2	10	80	16	6				
AEM90-AD07-D12-C10-L80-Z03-H	●	12	3	10	80	18	6				
AEM90-AD07-D12-C12-L90-Z03-H	●	12	3	12	90	18	6				
AEM90-AD07-D16-C16-L110-Z04-H	●	16	4	16	110	19	6				
AEM90-AD07-D20-C20-L125-Z05-H	●	20	5	20	125	20	6				
AEM90-AD07-D25-C25-L140-Z06-H	●	25	6	25	140	24	6	ADMX 0702..			
AEM90-AD11-D16-C16-L135-Z02-H	●	16	2	16	135	24	9				
AEM90-AD11-D18-C16-L135-Z02-H	●	18	2	16	135	15	9				
AEM90-AD11-D18-C16-L160-Z02-H	●	18	2	16	160	15	9				
AEM90-AD11-D20-C20-L150-Z02-H	●	20	2	20	150	50	9				
AEM90-AD11-D20-C20-L150-Z03-H	●	20	3	20	150	50	9				
AEM90-AD11-D22-C20-L150-Z03-H	●	22	3	20	150	15	9	ADMX 11T3..			
AEM90-AD11-D22-C20-L200-Z03-H	●	22	3	20	200	15	9				
AEM90-AD11-D25-C25-L170-Z03-H	●	25	3	25	170	50	9				
AEM90-AD11-D25-C25-L170-Z04-H	●	25	4	25	170	50	9				
AEM90-AD11-D28-C25-L165-Z04-H	●	28	4	25	165	17	9				
AEM90-AD11-D28-C25-L200-Z04-H	●	28	4	25	200	17	9				
AEM90-AD11-D30-C25-L165-Z04-H	●	30	4	25	165	19	9				
AEM90-AD11-D30-C25-L200-Z04-H	●	30	4	25	200	19	9				
AEM90-AD11-D32-C32-L195-Z05-H	●	32	5	32	195	50	9				
									3006-M2x3.1		
									3006-M2x3.3	82-T06	
									3006-M2x3.6		
									3006-M2x4		
									3008-M2.5x5		
									3008-M2.5x6	82-T08	

R: Sağ / Right / Правый L: Sol / Left / Левый

● Stokta / In Stock / В наличии ○ Stokta Yok / Non Stock Item / Нет в наличии

PRMT Ucuna Uygundur. / Compatible with PRMT Insert. / Под пластину PRMT.

Sipariş Örneği/Ordering Example/Образец заказа

1 ad./pcs./шт. AEM90-AD1505-D25-W25-L150-Z02

Kesme Hesabı : S 377 / Cutting Calculation : P 377 / Расчет режимов резания: стр. 377



www.akkо.com.tr

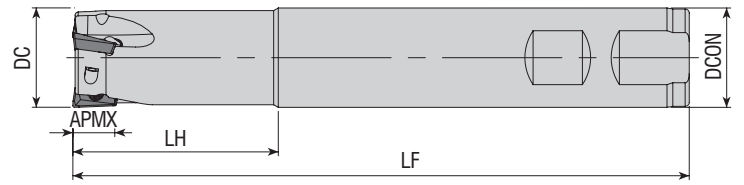

Takım Kodu Ordering Code Код для заказа	Stok Stock Наличие	Takım Ölçüleri (mm) Dimension (mm) Размеры (мм)						Kesici Uç Insert Пластина	Yedek Parçaları / Spare Parts / Залпасные части		
		DC	ZEFP	DCON	LF	LH	APMX		Sikma Vidası Screw Зажимной винт	Tork Anahtar Torx Key Торк Ключ	
AEM90-AD0803-D16-W16-L150-Z02	●	16	2	16	150	30	8	ADMT 0803..	3008-M2.5x5		
AEM90-AD0803-D17-W16-L150-Z02	●	17	2	16	150	30	8				
AEM90-AD0803-D17-W16-L200-Z02	●	17	2	16	200	30	8				
AEM90-AD0803-D20-W20-L150-Z03	●	20	3	20	150	30	8				
AEM90-AD0803-D21-W20-L200-Z03	●	21	3	20	200	30	8				
AEM90-AD10T3-D16-W16-L100-Z02-H	●	16	2	16	100	30	10	ADMT 10T3..	3008-M2.5x6	82-T08	
AEM90-AD10T3-D16-W16-L150-Z02	●	16	2	16	150	40	10				
AEM90-AD10T3-D16-C16-L200-Z02	●	16	2	16	200	50	10				
AEM90-AD10T3-D17-W16-L150-Z02	●	17	2	16	150	30	10				
AEM90-AD10T3-D17-W16-L200-Z02	●	17	2	16	200	30	10				
AEM90-AD10T3-D20-W20-L70-Z03	●	20	3	20	70	30	10				
AEM90-AD10T3-D20-W20-L100-Z03-H	●	20	3	20	100	30	10				
AEM90-AD10T3-D20-W20-L150-Z03	●	20	3	20	150	40	10				
AEM90-AD10T3-D20-C20-L150-Z03	●	20	3	20	150	40	10				
AEM90-AD10T3-D20-C20-L200-Z03	●	20	3	20	200	50	10				
AEM90-AD10T3-D25-W25-L100-Z03-H	●	25	3	25	100	30	10	ADMT 1204..	4010-M3x6	82-T10	
AEM90-AD10T3-D25-W25-L100-Z04-H	●	25	4	25	100	30	10				
AEM90-AD10T3-D25-W25-L150-Z03	●	25	3	25	150	50	10				
AEM90-AD1204-D20-W20-L150-Z02	●	20	2	20	150	50	12				
AEM90-AD1204-D21-C20-L150-Z02	●	21	2	20	150	30	12				
AEM90-AD1204-D22-C20-L150-Z02	●	22	2	20	150	30	12	ADMT 1606..	4015-M4x9	80-T15	
AEM90-AD1204-D25-W25-L150-Z03	●	25	3	25	150	50	12				
AEM90-AD1204-D26-W25-L180-Z03	●	26	3	25	180	30	12				
AEM90-AD1204-D32-W32-L150-Z04	●	32	4	32	150	50	12	ADMT 1606..	4015-M4x9	80-T15	
AEM90-AD1606-D25-W25-L150-Z02	●	25	2	25	150	50	15				
AEM90-AD1606-D32-W32-L150-Z03	●	32	3	32	150	50	15				

R: Sağ / Right / Правый L: Sol / Left / Левый
● Stokta / In Stock / В наличии ○ Stokta Yok / Non Stock Item / Нет в наличии
WLTR Ucuna Uygunudur. / Compatible with WLTR Insert. / Под пластину WLTR.

Sipariş Örneği/Ordering Example/Образец заказа
1 ad./pcs./шт. AEM90-AD0803-D16-W16-L150-Z02
Kesme Hesabı : S 377 / Cutting Calculation : P 377 / Расчет режимов резания: стр. 377

S-SİSTEM YÜZEY PARMAK FREZELER

S-SYSTEM END MILLS

S-ТИП КОНЦЕВЫЕ ФРЕЗЫ

KAPR=90°

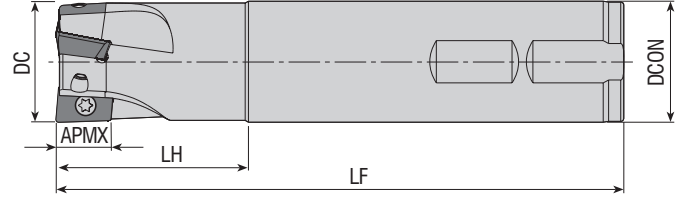

Takım Kodu Ordering Code Код для заказа	Stok Stock Наличие	Takım Ölçüleri (mm) Dimension (mm) Размеры (мм)						Kesici Uç Insert Пластина	Yedek Parçaları / Spare Parts / Запасные части	
		DC	ZEPF	DCON	LF	LH	APMX		Sıkma Vidası Screw Зажимной винт	Tork Anahtar Torx Key Торх Ключ
AEM90-AD1003-D16-C16-L150-Z02	●	16	2	16	150	30	8	ADMT 1003..	3008-M2.5x5	82-T08
AEM90-AD1003-D17-C16-L150-Z02	●	17	2	16	150	25	8			
AEM90-AD1003-D20-C20-L200-Z03	●	20	3	20	200	50	8			
AEM90-AD1003-D21-C20-L150-Z03	●	21	3	20	150	25	8			
AEM90-AD1003-D21-C20-L200-Z03	●	21	3	20	200	25	8			
AEM90-AD1003-D25-C25-L200-Z03	●	25	3	25	200	50	8			
AEM90-AD1003-D26-C25-L150-Z03	●	26	3	25	150	30	8			
AEM90-AD1003-D26-C25-L200-Z03	●	26	3	25	200	30	8			
AEM90-AD1505D-D25-W25-L150-Z02	●	25	2	25	150	50	14.3	ADKT 1505..	4015-M4x9	80-T15
AEM90-AD1505D-D32-W32-L150-Z03	●	32	3	32	150	50	14.3		4015-M4x11	

DJT Ucuna Uygunudur. / Compatible with DJT Insert. / Под пластину DJT

KAPR=90°

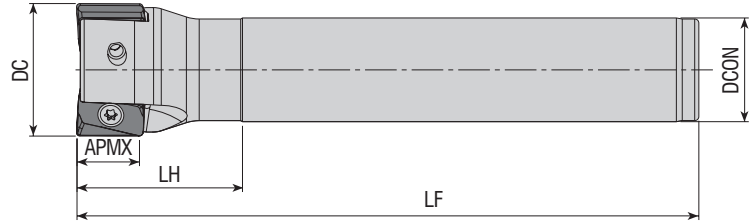

Takım Kodu Ordering Code Код для заказа	Stok Stock Наличие	Takım Ölçüleri (mm) Dimension (mm) Размеры (мм)						Kesici Uç Insert Пластина	Yedek Parçaları / Spare Parts / Запасные части	
		DC	ZEPF	DCON	LF	LH	APMX		Sıkma Vidası Screw Зажимной винт	Tork Anahtar Torx Key Торх Ключ
AEM90-AN11-D22-W20-L150-Z02	●	22	2	20	150	30	11	ANGX 1105..	4010-M3x8	82-T10
AEM90-AN11-D25-W25-L150-Z02	●	25	2	25	150	40	11			
AEM90-AN11-D25-C25-L200-Z02	●	25	2	25	200	40	11			
AEM90-AN11-D26-W25-L150-Z02	●	26	2	25	150	40	11			
AEM90-AN11-D28-W25-L150-Z02	●	28	2	25	150	25	11			
AEM90-AN11-D32-W32-L150-Z03	●	32	3	32	150	50	11			
AEM90-AN11-D32-C32-L200-Z03	●	32	3	32	200	50	11			
AEM90-AN11-D40-W32-L150-Z04	●	40	4	32	150	40	11			

R: Sağ / Right / Правый L: Sol / Left / Левый

● Stokta / In Stock / В наличии ○ Stokta Yok / Non Stock Item / Нет в наличии
ZCC Ucuna Uygunudur. / Compatible with ZCC Insert. / Под пластину ZCC

Sipariş Örneği/Ordering Example/Образец заказа

1 ad./pcs./шт. AEM90-AD1003-D16-C16-L150-Z02

Kesme Hesabı : S 377/ Cutting Calculation : P 377 / Расчет режимов резания: стр. 377



www.akkо.com.tr

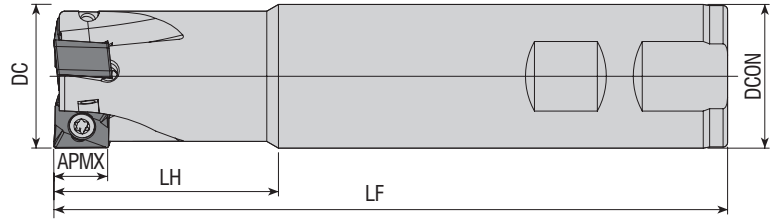

Takım Kodu Ordering Code Код для заказа	Stok Stock Наличие	Takım Ölçüleri (mm) Dimension (mm) Размеры (мм)						Kesici Uç Insert Пластина	Yedek Parçaları / Spare Parts / Запасные части	
		DC	ZEFP	DCON	LF	LH	APMX		Sıkma Vidası Screw Зажимной винт	Tork Anahtar Torx Key Торх Ключ
AEM90-AN1207-D25-W25-L150-Z02	●	25	2	25	150	40	10	ANKX 1207..		80-T15
AEM90-AN1207-D32-W32-L150-Z03	●	32	3	32	150	50	10			
AEM90-AN1207-D40-W32-L150-Z04	●	40	4	32	150	40	10			

XTC-GSC Ucuna Uygun. / Compatible with XTC-GSC Insert. / Под пластину XTC-GSC

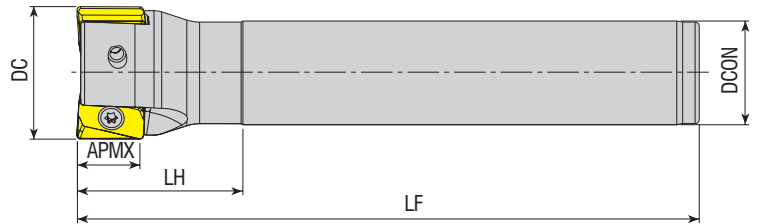

Takım Kodu Ordering Code Код для заказа	Stok Stock Наличие	Takım Ölçüleri (mm) Dimension (mm) Размеры (мм)						Kesici Uç Insert Пластина	Yedek Parçaları / Spare Parts / Запасные части	
		DC	ZEFP	DCON	LF	LH	APMX		Sıkma Vidası Screw Зажимной винт	Tork Anahtar Torx Key Торх Ключ
AEM90-AN1607-D32-C25-L150-Z02	●	32	2	25	150	50	15	AN.X 1607..		80-T15
AEM90-AN1607-D40-C32-L150-Z03	●	40	3	32	150	50	15			

R: Sağ / Right / Правый L: Sol / Left / Левый
● Stokta / In Stock / В наличии ○ Stokta Yok / Non Stock Item / Нет в наличии
TGTC Ucuna Uygun. / Compatible with TGTC Insert. / Под пластину TGTC.

Sipariş Örneği/Ordering Example/Образец заказа
1 ad./pcs./шт. AEM90-AN1207-D25-W25-L150-Z02
Kesme Hesabı : S 377/ Cutting Calculation : P 377 / Расчет режимов резания: стр. 377

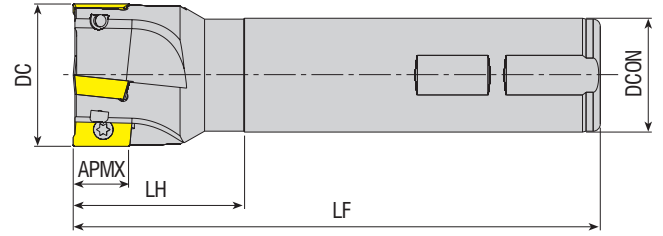

Takım Kodu Ordering Code Код для заказа	Stok Stock Наличие	Takım Ölçüleri (mm) Dimension (mm) Размеры (мм)						Kesici Uç Insert Пластина	Yedek Parçaları / Spare Parts / Запасные части		
		DC	ZEFP	DCON	LF	LH	APMX		Sıkma Vidası Screw Зажимной винт	Tork Anahtar Torx Key Торх Ключ	
AEM90-AP06-D10-C10-L120-Z02	●	10	2	10	120	20	5.6	APMT 0602.. KRLY UCUNA UYGUNDUR. FOR KRLY INSERT. Под пластину KRLY	3006-M1.8x4	82-T06	
AEM90-AP06-D12-C12-L120-Z02	●	12	2	12	120	20	5.6				
AEM90-AP0903-D12-C16-L080-Z01-H	●	12	1	16	80	30	9	APMT 0903.. KRLY UCUNA UYGUNDUR. FOR KRLY INSERT. Под пластину KRLY	3008-M2.5x5		
AEM90-AP0903-D16-C16-L090-Z02	●	16	2	16	90	30	9				
AEM90-AP0903-D16-C16-L150-Z02	●	16	2	16	150	30	9				
AEM90-AP0903-D17-C16-L150-Z02	●	17	2	16	150	30	9				
AEM90-AP0903-D18-C16-L090-Z02-H	●	18	2	16	90	30	9				
AEM90-AP0903-D20-C20-L110-Z03	●	20	3	20	110	30	9				
AEM90-AP0903-D20-C20-L150-Z02	●	20	2	20	150	30	9				
AEM90-AP0903-D20-C20-L200-Z02	●	20	2	20	200	100	9				
AEM90-AP0903-D21-C20-L150-Z02	●	21	2	20	150	30	9				
AEM90-AP0903-D25-C25-L120-Z03	●	25	3	25	120	30	9				
AEM90-AP0903-D25-C25-L150-Z03	●	25	3	25	150	30	9				
AEM90-AP0903-D25-C25-L200-Z02	●	25	2	25	200	100	9				
AEM90-AP09-D16-C16-L100-Z02-H	●	16	2	16	100	30	8.8	APKT 09T3.. TGTC UCUNA UYGUNDUR. FOR TGTC INSERT. Под пластину TGTC	3008-M2.5x5	82-T08	
AEM90-AP09-D16-C15-L150-Z02	●	16	2	15	150	25	8.8				
AEM90-AP09-D16-W16-L150-Z02-H	●	16	2	16	150	25	8.8				
AEM90-AP09-D16-C16-L200-Z02-H	●	16	2	16	200	100	8.8				
AEM90-AP09-D17-C16-L150-Z02	●	17	2	16	150	25	8.8				
AEM90-AP09-D17-C16-L180-Z02-H	●	17	2	16	180	25	8.8				
AEM90-AP09-D20-C20-L150-Z03-H	●	20	3	20	150	50	8.8				
AEM90-AP09-D20-C20-L200-Z03-H	●	20	3	20	200	100	8.8				
AEM90-AP09-D20-C20-L250-Z02-H	●	20	2	20	250	150	8.8				
AEM90-AP09-D21-C20-L150-Z03	●	21	3	20	150	25	8.8				
AEM90-AP09-D21-C20-L180-Z02-H	●	21	2	20	180	25	8.8				
AEM90-AP09-D26-C25-L150-Z04	●	26	4	25	150	30	8.8				
AEM90-AP10-D10-C10-L100-Z01	●	10	1	10	100	20	10	AP. 1003.. ISO UCUNA UYGUNDUR. FOR ISO INSERT. Под пластину ISO	3008-M2.5x5		
AEM90-AP10-D12-C16-L100-Z01-H	●	12	1	16	100	30	10				
AEM90-AP10-D12-W16-L100-Z01-H	●	12	1	16	100	30	10				
AEM90-AP10-D12-W16-L150-Z01	●	12	1	16	150	38	10				
AEM90-AP10-D14-W16-L100-Z01-H	●	14	1	16	100	30	10				
AEM90-AP10-D14-W16-L150-Z01	●	14	1	16	150	38	10				
AEM90-AP10-D16-C16-L100-Z02-H	●	16	2	16	100	30	10				
AEM90-AP10-D16-W16-L85-Z02-H	●	16	2	16	85	30	10				
AEM90-AP10-D16-W16-L100-Z02-H	●	16	2	16	100	30	10				
AEM90-AP10-D16-W16-L150-Z02-H	●	16	2	16	150	50	10				
AEM90-AP10-D16-W16-L200-Z02	●	16	2	16	200	100	10				
AEM90-AP10-D16-C16-L120-Z02-H	●	16	2	16	120	30	10				

R: Sağ / Right / Правый L: Sol / Left / Левый

● Stokta / In Stock / В наличии ○ Stokta Yok / Non Stock Item / Нет в наличии





www.akkо.com.tr

Sipariş Örneği/Ordering Example/Образец заказа

1 ad./pcs./шт. AEM90-AP06-D10-C10-L120-Z02

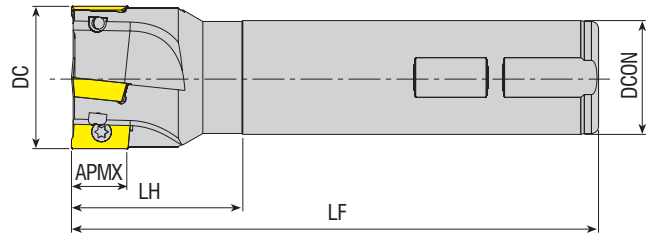
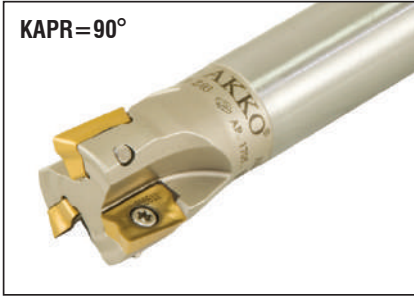
Kesme Hesabı : S 377 / Cutting Calculation : P 377 / Расчет режимов резания: стр. 377

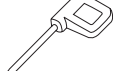

Takım Kodu Ordering Code Код для заказа	Stok Stock Наличие	Takım Ölçüleri (mm) Dimension (mm) Размеры (мм)						Kesici Uç Insert Пластина	Yedek Parçaları / Spare Parts / Залпасные части	
		DC	ZEFP	DCON	LF	LH	APMX		Sıkma Vidası Screw Зажимной винт	Tork Anahtar Torx Key Торх Ключ
AEM90-AP10-D16-C16-L150-Z02	●	16	2	16	150	50	10	 AP. 1003.. ISO UCUNA UYGUNDUR. FOR ISO INSERT. Под пластину ISO	 3008-M2.5x5	 82-T08
AEM90-AP10-D16-C16-L150-Z02-H	●	16	2	16	150	50	10			
AEM90-AP10-D16-W16-L150-Z02	●	16	2	16	150	50	10			
AEM90-AP10-D16-C16-L200-Z02	●	16	2	16	200	100	10			
AEM90-AP10-D16-C16-L200-Z02-H	●	16	2	16	200	100	10			
AEM90-AP10-D16-C16-L250-Z02	●	17	2	16	150	30	10			
new AEM90-AP10-D17-C16-L150-Z02	●	17	2	16	250	150	10			
AEM90-AP10-D18-W16-L100-Z02-H	●	18	2	16	100	30	10			
AEM90-AP10-D18-W16-L150-Z02	●	18	2	16	150	30	10			
new AEM90-AP10-D20-C19-L180-Z02	●	20	2	19	180	30	10			
AEM90-AP10-D20-C20-L100-Z03-H	●	20	3	20	100	30	10			
new AEM90-AP10-D20-W20-L90-Z03-H	●	20	3	20	90	30	10			
AEM90-AP10-D20-W20-L100-Z03-H	●	20	3	20	100	30	10			
AEM90-AP10-D20-C20-L120-Z03-H	●	20	3	20	120	30	10			
AEM90-AP10-D20-C20-L150-Z03	●	20	3	20	150	50	10			
AEM90-AP10-D20-C20-L150-Z03-H	●	20	3	20	150	50	10			
AEM90-AP10-D20-W20-L150-Z03	●	20	3	20	150	50	10			
AEM90-AP10-D20-C20-L200-Z02	●	20	2	20	200	100	10			
AEM90-AP10-D20-C20-L200-Z03-H	●	20	3	20	200	100	10			
AEM90-AP10-D20-C20-L250-Z02	●	20	2	20	250	150	10			
AEM90-AP10-D20-C20-L250-Z02-H	●	20	2	20	250	150	10			
new AEM90-AP10-D20.5-C20-L90-Z03	●	20.5	3	20	90	30	10			
new AEM90-AP10-D21-C20-L150-Z03	●	21	3	20	200	35	10			
AEM90-AP10-D21-C20-L200-Z03	●	21	3	20	200	30	10			
new AEM90-AP10-D21-C20-L200-Z03-H	●	21	3	20	200	35	10			
AEM90-AP10-D21-W20-L150-Z03	●	21	3	20	150	30	10			
AEM90-AP10-D22-W20-L100-Z03-H	●	22	3	20	100	30	10			
AEM90-AP10-D22-W20-L150-Z03	●	22	3	20	150	30	10			
new AEM90-AP10-D22.5-W20-L150-Z03	●	22.5	3	20	150	30	10			
AEM90-AP10-D23-W20-L150-Z03	●	23	3	20	150	30	10			
AEM90-AP10-D24-W20-L150-Z03	●	24	3	20	150	30	10			
AEM90-AP10-D25-W25-L100-Z04-H	●	25	4	25	100	30	10			
new AEM90-AP10-D25-W25-L95-Z04-H	●	25	4	25	95	30	10			
new AEM90-AP10-D25-W25-L150-Z04-H	●	25	4	25	150	50	10			
AEM90-AP10-D25-C25-L100-Z03-H	●	25	3	25	100	30	10			
AEM90-AP10-D25-W25-L100-Z03-H	●	25	3	25	100	30	10			
AEM90-AP10-D25-C25-L120-Z03-H	●	25	3	25	120	30	10			
AEM90-AP10-D25-C25-L150-Z03	●	25	3	25	150	50	10			
AEM90-AP10-D25-W25-L150-Z03	●	25	3	25	150	50	10			
AEM90-AP10-D25-C25-L200-Z02	●	25	2	25	200	100	10			
AEM90-AP10-D25-C25-L200-Z03	●	25	3	25	200	100	10			
AEM90-AP10-D25-C25-L250-Z02	●	25	2	25	250	100	10			
new AEM90-AP10-D26-C25-L200-Z04	●	26	4	25	200	35	10			

R: Sağ / Right / Правый L: Sol / Left / Левый
● Stokta / In Stock / В наличии ○ Stokta Yok / Non Stock Item / Нет в наличии

Sipariş Örneği/Ordering Example/Образец заказа
1 ad./pcs./шт. AEM90-AP10-D16-C16-L150-Z02
Kesme Hesabı : S 377 / Cutting Calculation : P 377 / Расчет режимов резания: стр. 377

S-SİSTEM YÜZEY PARMAK FREZELER

S-SYSTEM END MILLS

S-ТИП КОНЦЕВЫЕ ФРЕЗЫ

KAPR=90°

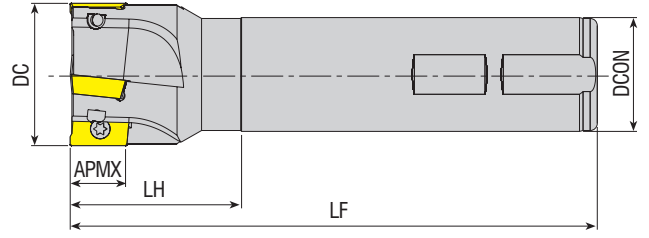
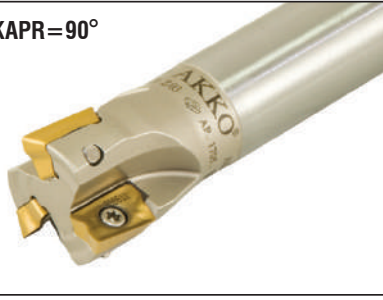

Takım Kodu
Ordering Code
Код для заказа

Stok
Stock
Наличие

Takım Ölçüleri (mm)
Dimension (mm)
Размеры (мм)

Kesici Uç
Insert
Пластина

Yedek Parçaları / Spare Parts / Залпасные части

Sıkma Vidası
Screw
Зажимной винт

Tork Anahtar
Torx Key
Торх Ключ

DC ZEFP DCON LF LH APMX

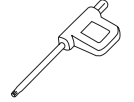

AEM90-AP10-D30-C25-L100-Z04-H	●	30	4	25	100	30	10	AP. 1003.. ISO UCUNA UYGUNDUR. FOR ISO INSERT. Под пластину ISO	3008-M2.5x6	
AEM90-AP10-D30-C25-L120-Z04-H	●	30	4	25	120	30	10			
AEM90-AP10-D30-C25-L150-Z04	●	30	4	25	150	30	10			
AEM90-AP10-D32-C25-L100-Z04-H	●	32	4	25	100	35	10			
AEM90-AP10-D32-C25-L120-Z04-H	●	32	4	25	120	35	10			
AEM90-AP10-D32-C25-L150-Z04	●	32	4	25	150	35	10			
AEM90-AP10-D32-W25-L150-Z04	●	32	4	25	150	35	10			
new AEM90-AP10-D32-C32-L170-Z04	●	32	4	32	170	50	10			
new AEM90-AP10-D32-W25-L105-Z05-H	●	32	5	25	105	35	10			
AEM90-AP10-D32-C32-L130-Z05	●	32	5	32	130	30	10			
AEM90-AP10-D32-W32-L150-Z04	●	32	4	32	150	50	10			
AEM90-AP10-D40-W32-L150-Z05	●	40	5	32	150	40	10			
AEM90-AP10D-D16-W16-L150-Z02	●	16	2	16	150	50	10			
AEM90-AP10D-D20-W20-L150-Z03	●	20	3	20	150	50	10			
AEM90-AP10D-D25-W20-L150-Z03	●	25	3	20	150	30	10			
AEM90-AP100-D16-C15-L150-Z02	●	16	2	15	150	30	10			
AEM90-AP100-D21-C20-L150-Z03	●	21	3	20	150	30	10			
AEM90-AP100-D26-C25-L150-Z04	●	26	4	25	150	35	10			
AEM90-AP100-D33-C32-L200-Z05	●	33	5	32	200	50	10			
AEM90-AP10S-D16-W16-L150-Z02	●	16	2	16	150	26	10			
AEM90-AP10S-D20-W20-L150-Z02	●	20	2	20	150	26	10			
AEM90-AP10S-D25-W25-L150-Z03	●	25	3	25	150	26	10			
AEM90-AP11-D16-C16-L150-Z02	●	16	2	16	150	50	11			
AEM90-AP11-D16-C16-L150-Z02-H	●	16	2	16	150	50	11			
AEM90-AP11-D16-W16-L150-Z02	●	16	2	16	150	50	11			
AEM90-AP11-D16-W16-L150-Z02-H	●	16	2	16	150	50	11			
AEM90-AP11-D16-C16-L200-Z02	●	16	2	16	200	100	11			
AEM90-AP11-D17-C16-L150-Z02	●	17	2	16	150	30	11			
AEM90-AP11-D17-C16-L200-Z02	●	17	2	16	200	30	11			
AEM90-AP11-D20-C20-L150-Z03	●	20	3	20	150	50	11			
AEM90-AP11-D20-W20-L150-Z03	●	20	3	20	150	50	11			
AEM90-AP11-D20-W20-L150-Z03-H	●	20	3	20	150	50	11			
AEM90-AP11-D20-C20-L200-Z03	●	20	3	20	200	100	11			
AEM90-AP11-D21-C20-L150-Z03	●	21	3	20	150	30	11			
AEM90-AP11-D21-W20-L150-Z03	●	21	3	20	150	30	11			
AEM90-AP11-D21-W20-L150-Z03-H	●	21	3	20	150	30	11			
AEM90-AP11-D21-C20-L200-Z03	●	21	3	20	200	30	11			
new AEM90-AP11-D22-C20-L180-Z03-H	●	22	3	20	180	30	11			
AEM90-AP11-D25-C25-L150-Z03	●	25	3	25	150	50	11			
AEM90-AP11-D25-W25-L150-Z03	●	25	3	25	150	50	11			
AEM90-AP11-D25-W25-L150-Z03-H	●	25	3	25	150	50	11			
AEM90-AP11-D26-C25-L150-Z03	●	26	3	25	150	35	11			
AEM90-AP11-D26-C24-L150-Z03	●	26	3	24	150	35	11			
new AEM90-AP11-D28-C25-L180-Z03-H	●	28	3	25	180	30	11			
AEM90-AP11-D32-W25-L150-Z04	●	32	4	25	150	35	11			
AEM90-AP11-D32-W32-L150-Z03-H	●	32	3	32	150	50	11			
AEM90-AP11-D32-W32-L150-Z04	●	32	4	32	150	50	11			

AP. 1003..
DJT UCUNA UYGUNDUR.
FOR DJT INSERT. Под пластину DJT

AP. 1003..
B.OKE UCUNA UYGUNDUR.
FOR B.OKE INSERT
Под пластину B.OKE

AP. 1003..
SMTM UCUNA UYGUNDUR.
FOR SMTM INSERT
Под пластину SMTM

AP. 11T3..
ZCC UCUNA UYGUNDUR.
FOR ZCC INSERT.
Под пластину ZCC

3008-M2.5x5

82-T08

3008-M2.5x6

R: Sağ / Right / Rechts L: Sol/Left/Links ● Stokta / In Stock / В наличии ○ Stokta Yok / Non Stock Item / Нет в наличии



www.akkо.com.tr

Sipariş Örneği/Ordering Example/Образец заказа

1 ad./pcs./шт. AEM90-AP10-D30-C25-L100-Z04-H

Kesme Hesabı : S 377 / Cutting Calculation : P 377 / Расчет режимов резания: стр. 377

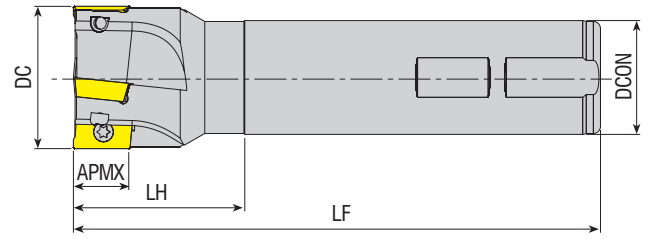
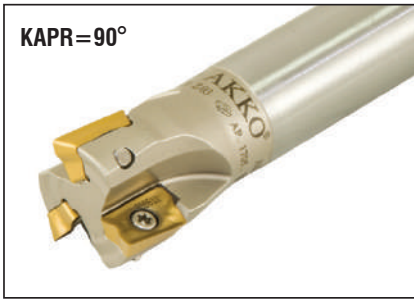

Takım Kodu Ordering Code Код для заказа	Stok Stock Наличие	Takım Ölçüleri (mm) Dimension (mm) Размеры (мм)						Kesici Uç Insert Пластина	Yedek Parçaları / Spare Parts / Залпасные части	
		DC	ZEP	DCON	LF	LH	APMX		Sıkma Vidası Screw Зажимной винт	Tork Anahtar Torx Key Торх Ключ
AEM90-AP1135A-D14-C16-L150-Z01	●	14	1	16	150	40	9.5	APMT 1135.. АЧТК UCUNA UYGUNDUR. FOR АЧТК INSERT. Под пластину АЧТК	3008-M2.5x5	82-T08
AEM90-AP1135A-D16-C16-L150-Z02	●	16	2	16	150	40	9.5			
AEM90-AP1135A-D16-C16-L200-Z02	●	16	2	16	200	100	9.5			
AEM90-AP1135A-D16-C16-L250-Z02	●	16	2	16	250	150	9.5			
AEM90-AP1135A-D17-C16-L180-Z02	●	17	2	16	180	30	9.5			
AEM90-AP1135A-D20-C20-L150-Z03	●	20	3	20	150	50	9.5			
AEM90-AP1135A-D20-C20-L200-Z02	●	20	2	20	200	100	9.5			
AEM90-AP1135A-D21-C20-L180-Z02	●	21	2	20	180	30	9.5			
AEM90-AP1135A-D25-C25-L200-Z03	●	25	3	25	200	100	9.5			
AEM90-AP1135A-D26-C25-L250-Z02	●	26	2	25	250	35	9.5			
AEM90-AP1135A-D33-C32-L250-Z02	●	33	2	32	250	35	9.5	AP. 1135.. B.ÖKE UCUNA UYGUNDUR. FOR B.ÖKE INSERT Под пластину B.ÖKE	3008-M2.5x5	
AEM90-AP110-D16-C15-L150-Z02	●	16	2	15	150	30	11			
AEM90-AP110-D21-C20-L150-Z03	●	21	3	20	150	30	11			
AEM90-AP110-D26-C25-L150-Z04	●	26	4	25	150	35	11			
AEM90-AP110-D33-C32-L200-Z05	●	33	5	32	200	50	11			
AEM90-APK11G-D16-W16-L150-Z02	●	16	2	16	150	26	11	APKT 1135.. XTC-GSC UCUNA UYGUNDUR. FOR XTC-GSC INSERT Под пластину XTC-GSC	3008-M3x5	
AEM90-APK11G-D20-W20-L150-Z03	●	20	3	20	150	26	11			
AEM90-APK11G-D25-W25-L150-Z03	●	25	3	25	150	26	11			
AEM90-AP1135-D16-W16-L110-Z02-H	●	16	2	16	110	30	9.5			
AEM90-AP1135-D16-W16-L150-Z02	●	16	2	16	150	50	9.5			
AEM90-AP1135-D20-W20-L125-Z03-H	●	20	3	20	125	30	9.5	AP. 1135.. XTC-GSC UCUNA UYGUNDUR. FOR XTC-GSC INSERT. Под пластину XTC-GSC	3008-M2.5x6	
AEM90-AP1135-D20-W20-L150-Z03	●	20	3	20	150	50	9.5			
AEM90-AP1135-D25-W25-L125-Z04-H	●	25	4	25	125	30	9.5			
AEM90-AP1135-D25-W25-L200-Z04-H	●	25	4	25	200	100	9.5			
AEM90-AP1135-D32-W32-L125-Z05-H	●	32	5	32	125	30	9.5			
AEM90-AP1135-D32-W32-L200-Z04-H	●	32	4	32	200	100	9.5	APMT 1135.. YG UCUNA UYGUNDUR. FOR YG INSERT. Под пластину YG	3008-M2.5x6	
AEM90-AP1135Y-D16-C16-L120-Z02-H	●	16	2	16	120	30	9.5			
AEM90-AP1135Y-D16-W16-L150-Z02	●	16	2	16	150	50	9.5			
AEM90-AP1135Y-D17-C16-L150-Z02	●	17	2	16	150	30	9.5			
AEM90-AP1135Y-D20-C20-L120-Z02	●	20	2	20	120	30	9.5			
AEM90-AP1135Y-D20-W20-L150-Z03	●	20	3	20	150	50	9.5			
AEM90-AP1135Y-D21-C20-L150-Z03	●	21	3	20	150	30	9.5			
AEM90-AP1135Y-D25-W25-L150-Z03	●	25	3	25	150	50	9.5			
AEM90-AP1135Y-D25-C25-L150-Z04-H	●	25	4	25	150	30	9.5			
AEM90-AP1135Y-D26-C25-L150-Z03	●	26	3	25	150	35	9.5			
AEM90-AP1135Y-D32-W25-L110-Z04	●	32	4	25	110	35	9.5	AP. 1204.. TGTC UCUNA UYGUNDUR. FOR TGTC INSERT. Под пластину TGTC	3010-M3.5x7	
AEM90-AP1204-D20-C20-L150-Z02	●	20	2	20	150	30	12			
AEM90-AP1204-D21-C20-L150-Z02	●	21	2	20	150	30	12			
AEM90-AP1204-D21-C20-L200-Z02	●	21	2	20	200	30	12			
AEM90-AP1204-D22-C20-L200-Z02	●	22	2	20	200	30	12			
AEM90-AP1204-D25-C25-L150-Z03	●	25	3	25	150	40	12	3010-M3.5x9		
AEM90-AP1204-D25-C25-L250-Z03	●	25	3	25	250	40	12			
AEM90-AP1204-D26-C25-L250-Z02	●	26	2	25	250	35	12			
AEM90-AP1204-D32-C25-L150-Z03	●	32	3	25	150	35	12	82-T10		

new

new

R: Sağ / Right / Правый L: Sol / Left / Левый
● Stokta / In Stock / В наличии ○ Stokta Yok / Non Stock Item / Нет в наличии

Sipariş Örneği/Ordering Example/Образец заказа
1 ad./pcs./шт. AEM90-AP1135A-D14-C16-L150-Z01
Kesme Hesabı : S 377/ Cutting Calculation : P 377 / Расчет режимов резания: стр. 277

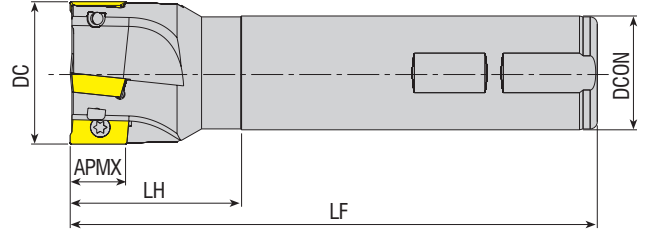
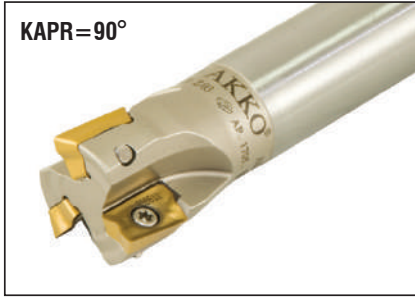

Takım Kodu Ordering Code Код для заказа	Stok Stock Наличие	Takım Ölçüleri (mm) Dimension (mm) Размеры (мм)						Kesici Uç Insert Пластина	Yedek Parçaları / Spare Parts / Запасные части	
		DC	ZEPF	DCON	LF	LH	APMX		Sıkma Vidası Screw Зажимной винт	Tork Anahtar Torx Key Торх Ключ
AEM90-AP16-D25-C20-L100-Z02	●	25	2	20	100	35	16	AP. 1604.. ISO UCUNA UYGUNDUR. FOR ISO INSERT Под пластину ISO	4015-M4x9	80-T15
AEM90-AP16-D25-W25-L100-Z02-H	●	25	2	25	100	35	16			
AEM90-AP16-D25-W25-L150-Z02	●	25	2	25	150	50	16			
AEM90-AP16-D25-C25-L250-Z02	●	25	2	25	250	100	16			
AEM90-AP16-D28-W25-L100-Z03-H	●	28	3	25	100	40	16			
AEM90-AP16-D28-W25-L150-Z03	●	28	3	25	150	40	16			
AEM90-AP16-D30-W25-L110-Z03-H	●	30	3	25	110	40	16			
AEM90-AP16-D30-W25-L150-Z02	●	30	2	25	150	40	16			
AEM90-AP16-D30-W25-L150-Z03	●	30	3	25	150	40	16			
AEM90-AP16-D32-W32-L110-Z03-H	●	32	3	32	110	40	16			
AEM90-AP16-D32-C32-L150-Z03	●	32	3	32	150	50	16			
AEM90-AP16-D32-W25-L150-Z03	●	32	3	25	150	40	16			
AEM90-AP16-D32-W32-L150-Z03	●	32	3	32	150	50	16			
AEM90-AP16-D32-W32-L150-Z03-H	●	32	3	32	150	50	16			
AEM90-AP16-D32-C25-L200-Z03-H	●	32	3	25	200	40	16			
AEM90-AP16-D32-C32-L250-Z02	●	32	2	32	250	100	16			
AEM90-AP16-D32-C32-L250-Z03	●	32	3	32	250	100	16			
AEM90-AP16-D35-W32-L150-Z03	●	35	3	32	150	40	16			
AEM90-AP16-D36-W32-L110-Z03-H	●	36	3	32	110	40	16			
AEM90-AP16-D36-W32-L150-Z03	●	36	3	32	150	40	16			
AEM90-AP16-D40-W32-L110-Z04-H	●	40	4	32	110	40	16			
AEM90-AP16-D40-C32-L150-Z04	●	40	4	32	150	40	16			
AEM90-AP16-D40-W32-L150-Z04	●	40	4	32	150	40	16			
AEM90-AP16-D40-C32-L250-Z02	●	40	2	32	250	40	16			
AEM90-AP16-D40-C32-L250-Z04	●	40	4	32	250	40	16			
AEM90-AP16DJ-D25-W25-L150-Z02	●	25	2	25	150	50	16	AP. 1604.. DJT UCUNA UYGUNDUR. FOR DJT INSERT. Под пластину DJT	4015-M4x9	80-T15
AEM90-AP16DJ-D25-C25-L200-Z02	●	25	2	25	200	50	16			
AEM90-AP16DJ-D32-W32-L150-Z03	●	32	3	32	150	50	16			
AEM90-AP16DJ-D32-C32-L180-Z03	●	32	3	32	180	50	16			
AEM90-AP16DJ-D32-C32-L200-Z03	●	32	3	32	200	50	16			
AEM90-AP16L-D25-C25-L120-Z02-H	●	25	2	25	120	45	16	AP. 1604.. LMN UCUNA UYGUNDUR. FOR LMN INSERT. Под пластину LMN	4015-M4x9	80-T15
AEM90-AP16L-D25-C25-L150-Z02	●	25	2	25	150	55	16			
AEM90-AP16L-D25-C25-L200-Z02	●	25	2	25	200	55	16			
AEM90-AP16L-D25-C25-L250-Z02	●	25	2	25	250	100	16			
AEM90-AP16L-D30-W25-L120-Z03-H	●	30	3	25	120	40	16			
AEM90-AP16L-D32-C32-L120-Z03-H	●	32	3	32	120	45	16			
AEM90-AP16L-D32-C32-L150-Z03	●	32	3	32	150	55	16			
AEM90-AP16L-D32-C32-L200-Z03	●	32	3	32	200	55	16			
AEM90-AP16L-D32-C32-L250-Z03	●	32	3	32	250	100	16			
AEM90-AP16L-D40-C32-L120-Z04-H	●	40	4	32	120	40	16			
AEM90-AP16L-D40-C32-L150-Z04	●	40	4	32	150	40	16			
AEM90-AP16L-D40-C32-L200-Z04	●	40	4	32	200	40	16			
AEM90-AP16L-D40-C32-L250-Z04	●	40	4	32	250	40	16			

R: Sağ / Right / Правый L: Sol / Left / Левый

● Stokta / In Stock / В наличии ○ Stokta Yok / Non Stock Item / Нет в наличии

Sipariş Örneği/Ordering Example/Образец заказа

1 ad./pcs./шт. AEM90-AP16-D25-C20-L100-Z02

Kesme Hesabı : S 377 / Cutting Calculation : P 377 / Расчет режимов резания: стр. 377

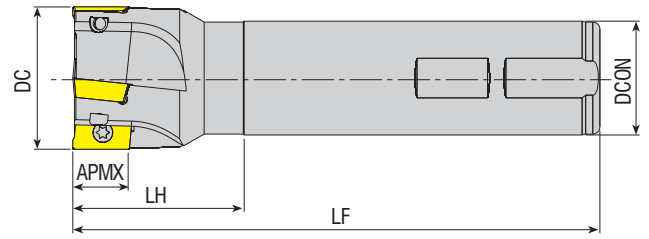
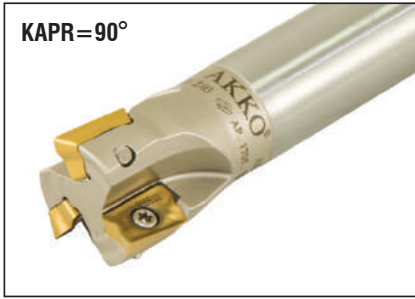

Takım Kodu Ordering Code Код для заказа	Stok Stock Наличие	Takım Ölçüleri (mm) Dimension (mm) Размеры (мм)						Kesici Uç Insert Пластина	Yedek Parçaları / Spare Parts / Запасные части	
		DC	ZEFP	DCON	LF	LH	APMX		Sıkma Vidası Screw Зажимной винт	Tork Anahtar Torx Key Торх Ключ
AEM90-AP16P-D25-W25-L100-Z02-H	●	25	2	25	100	35	16	AP. 1604.. PLBT UCUNA UYGUNDUR. FOR PLBT INSERT. Под пластину PLBT	4015-M4x9	80-T15
AEM90-AP16P-D25-W25-L150-Z02	●	25	2	25	150	50	16			
AEM90-AP16P-D32-W32-L150-Z03	●	32	3	32	150	50	16			
AEM90-AP16P-D32-C32-L250-Z02	●	32	2	32	250	100	16			
AEM90-AP16P-D40-W32-L150-Z04	●	40	4	32	150	50	16	AP. 1604.. YG UCUNA UYGUNDUR. FOR YG INSERT. Под пластину YG	4015-M4x9	80-T15
AEM90-AP16Y-D25-C20-L100-Z02-H	●	25	2	20	100	35	16			
AEM90-AP16Y-D25-C25-L120-Z02	●	25	2	25	120	50	16			
AEM90-AP16Y-D25-C25-L150-Z02	●	25	2	25	150	50	16			
AEM90-AP16Y-D25-C25-L250-Z02	●	25	2	25	250	100	16	AP. 1705.. TGTC-LMN UCUNA UYGUNDUR. FOR TGTC-LMN INSERT. Под пластину TGTC-LMN	4015-M4x9	80-T15
AEM90-AP1705-D25-C25-L120-Z02	●	25	2	25	120	40	16			
AEM90-AP1705-D26-C25-L200-Z02	●	26	2	25	200	40	16			
AEM90-AP1705-D26-C25-L250-Z02	●	26	2	25	250	40	16			
AEM90-AP1705-D26-C25-L300-Z02	○	26	2	25	300	40	16	AP. 1705.. TGTC-LMN UCUNA UYGUNDUR. FOR TGTC-LMN INSERT. Под пластину TGTC-LMN	4015-M4x9	80-T15
AEM90-AP1705-D28-W25-L075-Z02	●	28	2	25	75	20	16			
AEM90-AP1705-D32-C25-L150-Z03	●	32	3	25	150	40	16			
AEM90-AP1705-D33-C32-L250-Z03	●	33	3	32	250	40	16			
AEM90-AP1705-D33-C32-L300-Z02	●	33	2	32	300	40	16			

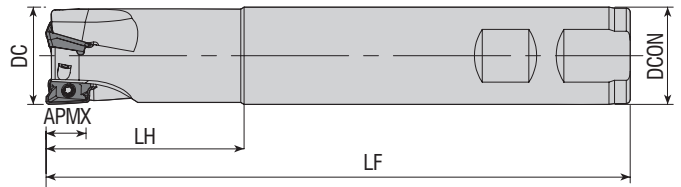

Takım Kodu Ordering Code Код для заказа	Stok Stock Наличие	Takım Ölçüleri (mm) Dimension (mm) Размеры (мм)						Kesici Uç Insert Пластина	Yedek Parçaları / Spare Parts / Запасные части	
		DC	ZEFP	DCON	LF	LH	APMX		Sıkma Vidası Screw Зажимной винт	Tork Anahtar Torx Key Торх Ключ
AEM90-A01236-D16-W16-L150-Z02	●	16	2	16	150	50	10	A0.1236..	3008-M2.5x6	82-T08
new AEM90-A01236-D16-C16-L160-Z02-H	●	16	2	16	160	25	10			
new AEM90-A01236-D17-C16-L150-Z02-H	●	17	2	16	150	25	10			
new AEM90-A01236-D18-C16-L160-Z02-H	●	18	2	16	160	25	10			
new AEM90-A01236-D20-C20-L160-Z03-H	●	20	3	20	160	30	10			
AEM90-A01236-D20-C20-L100-Z02	●	20	2	20	100	30	10			
new AEM90-A01236-D21-C20-L220-Z03-H	●	21	3	20	220	30	10			
new AEM90-A01236-D22-C20-L160-Z03-H	●	22	3	20	160	30	10			
AEM90-A01236-D25-C25-L115-Z02	●	25	2	25	150	50	10			
new AEM90-A01236-D25-C25-L160-Z04-H	●	25	4	25	160	50	10			
AEM90-A01236-D25-W25-L150-Z03	●	25	3	25	150	50	10			
new AEM90-A01236-D26-C25-L150-Z04-H	●	26	4	25	150	35	10			
new AEM90-A01236-D26-C25-L160-Z04-H	●	26	4	25	160	35	10			
AEM90-A01236-D32-W32-L150-Z04	●	32	4	32	150	50	10			
new AEM90-A01236-D32-C32-L160-Z05-H	●	32	5	32	160	50	10			

R: Sağ / Right / Правый L: Sol / Left / Левый

● Stokta / In Stock / В наличии ○ Stokta Yok / Non Stock Item / Нет в наличии

MTSBH Ucuna Uygundur. / Compatible with MTSBH Insert. / Под пластину MTSBH.

Sipariş Örneği/Ordering Example/Образец заказа

1 ad./pcs./шт. AEM90-AP16P-D25-W25-L100-Z02-H

Kesme Hesabı : S 367 / Cutting Calculation : P 367 / Расчет режимов резания: стр. 367

S-SİSTEM YÜZEY PARMAK FREZELER

S-SYSTEM END MILLS

S-ТИП КОНЦЕВЫЕ ФРЕЗЫ

KAPR=90°

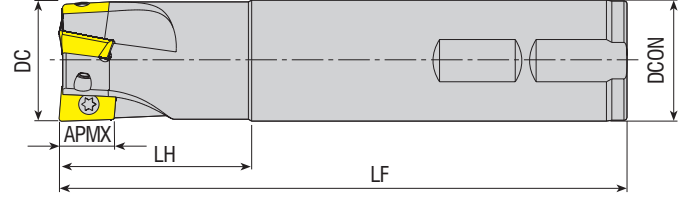

Takım Kodu Ordering Code Код для заказа	Stok Stock Наличие	Takım Ölçüleri (mm) Dimension (mm) Размеры (мм)						Kesici Uç Insert Пластина	Yedek Parçaları / Spare Parts / Залпасные части	
		DC	ZEFP	DCON	LF	LH	APMX		Sıkma Vidası Screw Зажимной винт	Tork Anahtar Torx Key Торх Ключ
AEM90-AX0602-D10-C09-L120-Z02	●	10	2	9	120	20	5.7	AX.. 0602	3006-M1.8x4	82-T06
AEM90-AX0602-D10-C10-L080-Z02	●	10	2	10	80	20	5.7			
AEM90-AX0602-D10-C10-L120-Z02	●	10	2	10	120	20	5.7			
AEM90-AX0602-D12-C11-L120-Z02	●	12	2	11	120	20	5.7			
AEM90-AX0602-D12-C12-L080-Z02	●	12	2	12	80	20	5.7			
AEM90-AX0602-D12-C12-L120-Z02	●	12	2	12	120	20	5.7			
AEM90-AX0602-D14-C12-L120-Z03	●	14	3	12	120	20	5.7			
AEM90-AX0602-D16-W16-L120-Z04-H	●	16	4	16	120	20	5.7			
AEM90-AX0602-D16-W16-L150-Z04-H	●	16	4	16	150	20	5.7			
AEM90-AX0602-D20-W20-L120-Z05-H	●	20	5	20	120	25	5.7			
AEM90-AX0602-D20-W20-L150-Z05-H	●	20	5	20	150	25	5.7			
AEM90-AX0903-D16-C16-L120-Z02	●	16	2	16	120	30	8.8	AX.. 0903	3008-M2.5x5	82-T08
AEM90-AX0903-D16-C16-L180-Z02	●	16	2	16	180	30	8.8			
AEM90-AX0903-D17-C16-L120-Z02	●	17	2	16	120	25	8.8			
AEM90-AX0903-D17-C16-L180-Z02	●	17	2	16	180	25	8.8			
AEM90-AX0903-D20-C20-L120-Z03	●	20	3	20	120	30	8.8			
AEM90-AX0903-D20-C20-L200-Z02	●	20	2	20	200	30	8.8			
AEM90-AX0903-D21-C20-L120-Z03	●	21	3	20	120	25	8.8			
AEM90-AX0903-D21-C20-L200-Z02	●	21	2	20	200	25	8.8			
AEM90-AX0903-D25-C25-L150-Z03	●	25	3	25	150	30	8.8			
AEM90-AX0903-D25-C25-L250-Z02	●	25	2	25	250	40	8.8			
AEM90-AX0903-D26-C25-L150-Z03	●	26	3	25	150	30	8.8			

R: Sağ / Right / Правый L: Sol / Left / Левый

● Stokta / In Stock / В наличии ○ Stokta Yok / Non Stock Item / Нет в наличии
TGTC Ucuна Uygundur. / Compatible with TGTC Insert. / Под пластину TGTC.

Sipariş Örneği/Ordering Example/Образец заказа

1 ad./pcs./шт. AEM90-AX0602-D10-C09-L120-Z02

Kesme Hesabı : S 377/ Cutting Calculation : P 377 / Расчет режимов резания: стр. 377



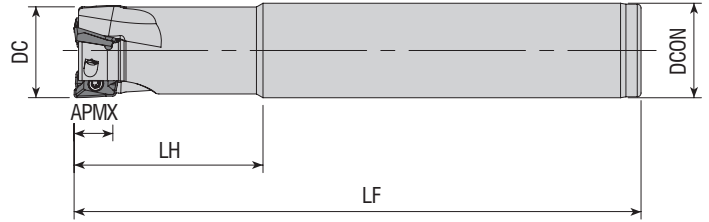

Takım Kodu Ordering Code Код для заказа	Stok Stock Наличие	Takım Ölçüleri (mm) Dimension (mm) Размеры (мм)						Kesici Uç Insert Пластина	Yedek Parçaları / Spare Parts / Запасные части		
		DC	ZEFP	DCON	LF	LH	APMX		Sıkma Vidası Screw Зажимной винт	Tork Anahtar Torx Key Торх Ключ	
AEM90-AX1235-D16-C14-L120-Z02-H	●	16	2	14	120	25	10	AX.T 1235..	3008-M3x6	82-T08	
AEM90-AX1235-D16-C15-L145-Z02-H	●	16	2	15	145	30	10		3108-M3x6		
AEM90-AX1235-D16-C16-L100-Z02-H	●	16	2	16	100	30	10		3008-M3x6		
AEM90-AX1235-D16-C16-L140-Z02-H	●	16	2	16	140	30	10		3108-M3x6		
AEM90-AX1235-D16-C16-L145-Z02-H	●	16	2	16	145	30	10		3008-M3x6		
AEM90-AX1235-D16-C16-L150-Z02	●	16	2	16	150	30	10		3108-M3x6		
AEM90-AX1235-D20-C19-L150-Z02-H	●	20	2	19	150	40	10		3008-M3x6		
AEM90-AX1235-D20-C20-L110-Z03-H	●	20	3	20	110	40	10		3108-M3x6		
AEM90-AX1235-D20-C20-L150-Z02	●	20	2	20	150	40	10		3008-M3x6		
AEM90-AX1235-D20-C20-L150-Z02-H	●	20	2	20	150	40	10		3108-M3x6		
AEM90-AX1235-D20-C20-L150-Z03	●	20	3	20	150	40	10		3008-M3x6		
AEM90-AX1235-D25-C20-L120-Z04-H	●	25	4	20	120	30	10		3108-M3x6		
AEM90-AX1235-D25-C20-L150-Z04-H	●	25	4	20	150	30	10		3008-M3x6		
AEM90-AX1235-D25-C24-L170-Z02-H	●	25	2	24	170	50	10		3108-M3x6		
AEM90-AX1235-D25-C25-L120-Z04-H	●	25	4	25	120	40	10		3008-M3x6		
AEM90-AX1235-D25-C25-L150-Z03	●	25	3	25	150	50	10		3108-M3x6		
AEM90-AX1235-D25-C25-L170-Z02-H	●	25	2	25	170	50	10		3008-M3x6		
AEM90-AX1235-D25-W25-L100-Z04-H	●	25	4	25	100	30	10		3108-M3x6		
AEM90-AX1235-D32-C32-L130-Z05-H	●	32	5	32	130	40	10		4015-M4x9		80-T15
AEM90-AX1235-D32-C32-L180-Z02-H	●	32	2	32	180	50	10				
AEM90-AX1705-D25-C25-L150-Z02	●	25	2	25	150	50	14				
AEM90-AX1705-D28-W25-L115-Z02-H	●	28	2	25	115	35	14				
AEM90-AX1705-D32-C32-L150-Z03	●	32	3	32	150	50	14	4015-M4x9	80-T15		
AEM90-AX1705-D32-C32-L180-Z02-H	●	32	2	32	180	50	14				

R: Sağ / Right / Правый L: Sol / Left / Левый
● Stokta / In Stock / В наличии ○ Stokta Yok / Non Stock Item / Нет в наличии
SMTM Ucuna Uygunudur. / Compatible with SMTM Insert / Под пластину SMTM.

Sipariş Örneği/Ordering Example/Образец заказа
1 ad./pcs./шт. AEM90-AX1235-D16-C14-L120-Z02-H
Kesme Hesabı : S 377 / Cutting Calculation : P 377 / Расчет режимов резания: стр. 377





S-SİSTEM YÜZEY PARMAK FREZELER

S-SYSTEM END MILLS

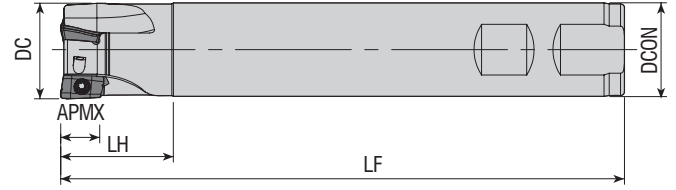
S-ТИП КОНЦЕВЫЕ ФРЕЗЫ

KAPR=90°



Takım Kodu Ordering Code Код для заказа	Stok Stock Наличие	Takım Ölçüleri (mm) Dimension (mm) Размеры (мм)						Kesici Uç Insert Пластина	Yedek Parçaları / Spare Parts / Запасные части		
		DC	ZEFP	DCON	LF	LH	APMX		Sıkma Vidası Screw Зажимной винт	Tork Anahtar Torx Key Торх Ключ	
AEM90-AZ11-D12-W16-L90-Z01	●	12	1	16	90	30	11				
AEM90-AZ11-D16-C16-L200-Z02	●	16	2	16	200	100	11				
AEM90-AZ11-D16-W15-L170-Z02	●	16	2	15	170	50	11				
AEM90-AZ11-D16-W16-L100-Z02	●	16	2	16	100	35	11				
AEM90-AZ11-D16-W16-L150-Z02	●	16	2	16	150	50	11				
AEM90-AZ11-D17-C16-L150-Z02	●	17	2	16	150	30	11				
AEM90-AZ11-D17-C16-L180-Z02	●	17	2	16	180	50	11				
AEM90-AZ11-D17-W16-L100-Z02	●	17	2	16	100	30	11				
AEM90-AZ11-D18-W16-L120-Z02	●	18	2	16	120	18	11				
AEM90-AZ11-D20-C20-L200-Z03	●	20	3	20	200	100	11				
AEM90-AZ11-D20-W19-L170-Z03	●	20	3	19	170	50	11				
AEM90-AZ11-D20-W20-L110-Z02	●	20	2	20	110	35	11				
AEM90-AZ11-D21-C20-L150-Z03	●	21	3	20	150	30	11				
AEM90-AZ11-D21-C20-L180-Z03	●	21	3	20	180	50	11				
AEM90-AZ11-D21-W20-L110-Z03	●	21	3	20	110	35	11				
AEM90-AZ11-D22-C20-L150-Z02	●	22	2	20	150	30	11				
AEM90-AZ11-D25-C24-L180-Z04	●	25	4	24	180	50	11				
AEM90-AZ11-D25-W25-L110-Z04	●	25	4	25	110	40	11				
AEM90-AZ11-D26-C25-L250-Z02	●	26	2	25	250	50	11				
AEM90-AZ11-D26-W25-L120-Z03	●	26	3	25	120	30	11				
AEM90-AZ11-D26-W25-L120-Z04	●	26	4	25	120	40	11				
AEM90-AZ11-D28-C25-L180-Z03	●	28	3	25	180	50	11				
AEM90-AZ11-D28-C25-L250-Z02	●	28	2	25	250	50	11				
AEM90-AZ11-D33-W32-L130-Z04	●	33	4	32	130	50	11				

R: Sağ / Right / Правый L: Sol / Left / Левый

● Stokta / In Stock / В наличии ○ Stokta Yok / Non Stock Item / Нет в наличии
ZCC Ucuna Uygunudur. / Compatible with ZCC Insert. / Под пластину ZCC

Sipariş Örneği/Ordering Example/Образец заказа

1 ad./pcs./шт. AEM90-AZ11-D12-W16-L90-Z01

Kesme Hesabı : S 377 / Cutting Calculation : P 377 / Расчет режимов резания: стр. 377

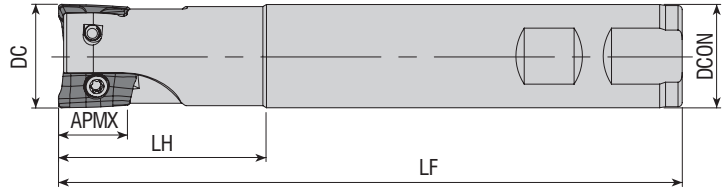

Takım Kodu
Ordering Code
Код для заказа

Stok
Stock
Наличие

Takım Ölçüleri (mm)
Dimension (mm)
Размеры (мм)

Kesici Uç
Insert
Пластина

Yedek Parçaları / Spare Parts / Запасные части

Sıkma Vidası
Screw
Зажимной винт

Tork Anahtar
Torx Key
Торх Ключ

DC ZEFP DCON LF LH APMX



AEM90-BD11T3-D16-C16-L100-Z02-H	●	16	2	16	100	30	10	BDMT 11T3..	3008-M2.5x5	82-T08
AEM90-BD11T3-D16-W16-L100-Z02-H	●	16	2	16	100	30	10			
AEM90-BD11T3-D16-W16-L150-Z02	●	16	2	16	150	50	10			
AEM90-BD11T3-D16-C16-L160-Z02-H	●	16	2	16	160	60	10			
AEM90-BD11T3-D16-C15-L180-Z02	●	16	2	15	180	50	10			
AEM90-BD11T3-D17-W16-L150-Z02	●	17	2	16	150	25	10			
AEM90-BD11T3-D17-C16-L180-Z02	●	17	2	16	180	25	10			
AEM90-BD11T3-D18-W16-L100-Z02	●	18	2	16	100	25	10			
AEM90-BD11T3-D18-W16-L100-Z02-H	●	18	2	16	100	25	10			
new AEM90-BD11T3-D20-W16-L61-Z03	●	20	3	16	61	26	10			
AEM90-BD11T3-D20-W20-L81-Z03-H	●	20	3	20	81	30	10			
AEM90-BD11T3-D20-W20-L100-Z02-H	●	20	2	20	100	30	10			
AEM90-BD11T3-D20-W20-L100-Z03-H	●	20	3	20	100	30	10			
AEM90-BD11T3-D20-C20-L110-Z03-H	●	20	3	20	110	30	10			
AEM90-BD11T3-D20-W20-L150-Z02	●	20	2	20	150	50	10			
AEM90-BD11T3-D20-W20-L150-Z03	●	20	3	20	150	50	10			
AEM90-BD11T3-D20-W20-L150-Z03-H	●	20	3	20	150	50	10			
AEM90-BD11T3-D20-C20-L170-Z03-H	●	20	3	20	170	60	10			
AEM90-BD11T3-D21-W20-L150-Z03	●	21	3	20	150	25	10			
AEM90-BD11T3-D21-C20-L200-Z02	●	21	2	20	200	25	10			
new AEM90-BD11T3-D22-W20-L090-Z02-H	●	22	2	20	90	25	10			
AEM90-BD11T3-D22-W20-L100-Z03-H	●	22	3	20	100	30	10			
AEM90-BD11T3-D25-W25-L100-Z03-H	●	25	3	25	100	30	10			
AEM90-BD11T3-D25-C20-L120-Z03-H	●	25	3	20	120	30	10			
AEM90-BD11T3-D25-C25-L120-Z03-H	●	25	3	25	120	30	10			
AEM90-BD11T3-D25-W25-L150-Z03	●	25	3	25	150	50	10			
AEM90-BD11T3-D26-W25-L150-Z03	●	26	3	25	150	35	10			
AEM90-BD11T3-D26-C25-L250-Z02	●	26	2	25	250	35	10			
AEM90-BD11T3-D32-W32-L110-Z04-H	●	32	4	32	110	40	10			
AEM90-BD11T3-D32-C32-L130-Z04-H	●	32	4	32	130	40	10			
AEM90-BD11T3-D32-W32-L150-Z04	●	32	4	32	150	50	10			
AEM90-BD11T3-D40-W32-L110-Z04-H	●	40	4	32	110	35	10			
AEM90-BD1704-D25-W25-L100-Z02-H	●	25	2	25	100	35	15.7	BDMT 1704..	4015-M4x8	80-T15
AEM90-BD1704-D25-W25-L150-Z02	●	25	2	25	150	50	15.7			
AEM90-BD1704-D25-C25-L210-Z02-H	●	25	2	25	210	100	15.7			
AEM90-BD1704-D32-W32-L110-Z03-H	●	32	3	32	110	40	15.7			
AEM90-BD1704-D32-C32-L130-Z03-H	●	32	3	32	130	40	15.7			
AEM90-BD1704-D32-W32-L130-Z03-H	●	32	3	32	130	40	15.7			
AEM90-BD1704-D32-W32-L150-Z03	●	32	3	32	150	50	15.7			
AEM90-BD1704-D40-W32-L110-Z04-H	●	40	4	32	110	40	15.7			
AEM90-BD1704-D40-W32-L150-Z04	●	40	4	32	150	40	15.7			

R: Sağ / Right / Правый L: Sol / Left / Левый

● Stokta / In Stock / В наличии ○ Stokta Yok / Non Stock Item / Нет в наличии

KYCR Ucuna Uygundur. / Compatible with KYCR Insert. / Под пластину KYCR

Sipariş Örneği/Ordering Example/Образец заказа

1 ad./pcs./шт. AEM90-BD11T3-D16-C16-L100-Z02-H

Kesme Hesabı : S 367 / Cutting Calculation : P 367 / Расчет режимов резания: стр. 367

S-SİSTEM YÜZEY PARMAK FREZELER

S-SYSTEM END MILLS

S-ТИП КОНЦЕВЫЕ ФРЕЗЫ

KAPR=90°

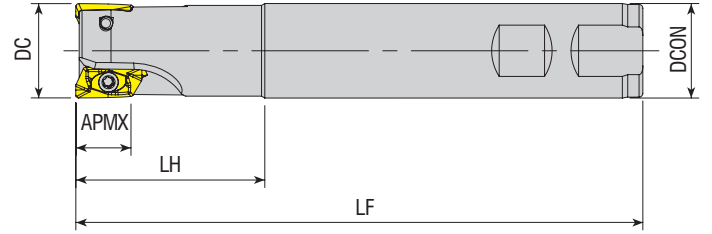

Takım Kodu Ordering Code Код для заказа	Stok Stock Наличие	Takım Ölçüleri (mm) Dimension (mm) Размеры (мм)						Kesici Uç Insert Пластина	Yedek Parçaları / Spare Parts / Запасные части		
		DC	ZEFP	DCON	LF	LH	APMX		Sıkma Vidası Screw Зажимной винт	Tork Anahtar Torx Key Торх Ключ	
AEM90-ED10T3-D16-W16-L120-Z02	●	16	2	16	120	30	10	EDPT 10T3..	3008-M2.5x5	82-T08	
AEM90-ED10T3-D20-W20-L120-Z02	●	20	2	20	120	30	10		3008-M2.5x6		
AEM90-ED1404-D20-W20-L150-Z02	●	20	2	20	150	50	14.5	EDPT 1404..	3008-M3x6		
AEM90-ED1404-D25-W25-L150-Z02	●	25	2	25	150	50	14.5				
AEM90-ED1404-D30-C25-L150-Z03	●	30	3	25	150	50	14.5				

KNMTL Ucuna Uygunudur. / Compatible with KNMTL Insert. / Под пластину KNMTL

KAPR=90°

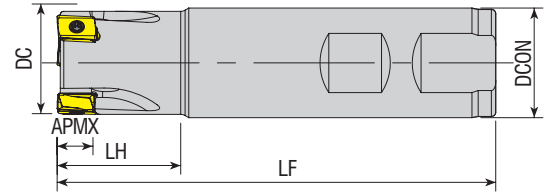

Takım Kodu Ordering Code Код для заказа	Stok Stock Наличие	Takım Ölçüleri (mm) Dimension (mm) Размеры (мм)						Kesici Uç Insert Пластина	Yedek Parçaları / Spare Parts / Запасные части		
		DC	ZEFP	DCON	LF	LH	APMX		Sıkma Vidası Screw Зажимной винт	Tork Anahtar Torx Key Торх Ключ	
AEM90-LN08-D16-W16-L100-Z02-H	●	16	2	16	100	28	8	LNMT 0804..	1707-U4-48x6	82-T07	
AEM90-LN08-D16-W16-L150-Z02	●	16	2	16	150	40	8				1707-U4-48x6.5
AEM90-LN08-D20-W20-L100-Z03-H	●	20	3	20	100	28	8		1707-U4-48x8.2		
AEM90-LN08-D25-W25-L100-Z03-H	●	25	3	25	100	30	8				
AEM90-LN08-D32-W32-L110-Z05-H	●	32	5	32	110	30	8				
new AEM90-LN1306-D32-W32-L150-Z03	●	32	3	32	150	50	12.5	LNMT 1306..	4015-M4x11	80-T15	
new AEM90-LN1306-D32-C32-L110-Z03-H	●	36	3	32	110	40	12.5				

R: Sağ / Right / Правый L: Sol / Left / Левый

● Stokta / In Stock / В наличии ○ Stokta Yok / Non Stock Item / Нет в наличии

ISCR Ucuna Uygunudur. / Compatible with ISCR Insert. / Под пластину ISCR

Sipariş Örneği/Ordering Example/Образец заказа

1 ad./pcs./шт. AEM90-ED10T3-D16-W16-L120-Z02

Kesme Hesabı : S 377 / Cutting Calculation : P 377 / Расчет режимов резания: стр. 377



www.akkо.com.tr

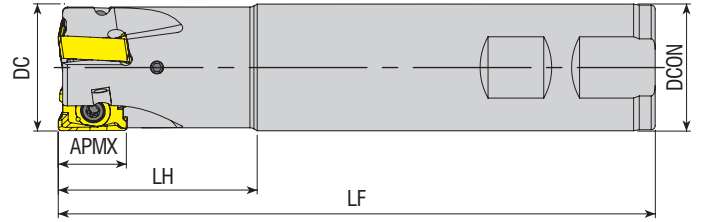

Takım Kodu Ordering Code Код для заказа	Stok Stock Наличие	Takım Ölçüleri (mm) Dimension (mm) Размеры (мм)						Kesici Uç Insert Пластина	Yedek Parçaları / Spare Parts / Запасные части		
		DC	ZEFP	DCON	LF	LH	APMX		Sıkma Vidası Screw Зажимной винт	Tork Anahtar Torx Key Торх Ключ	
AEM90-LN15T6-D25-W25-L150-Z02-H	●	25	2	25	150	50	15.5	LNGU 15T6..		4015-M4x12	
AEM90-LN15T6-D32-W32-L150-Z03-H	●	32	3	32	150	50	15.5				
AEM90-LN15T6-D40-W32-L150-Z03-H	●	40	3	32	150	40	15.5				

KNMTL Ucuna Uygundur. / Compatible with KNMTL Insert. / Под пластину KNMTL

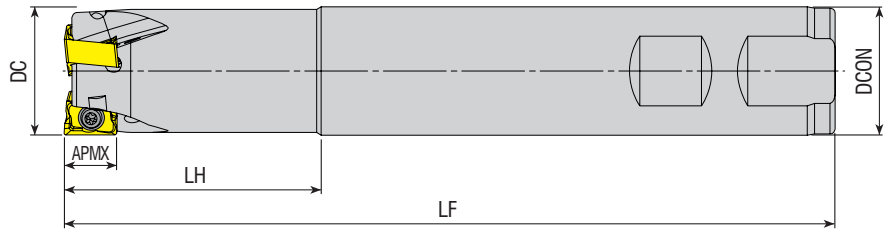

Takım Kodu Ordering Code Код для заказа	Stok Stock Наличие	Takım Ölçüleri (mm) Dimension (mm) Размеры (мм)						Kesici Uç Insert Пластина	Yedek Parçaları / Spare Parts / Запасные части		
		DC	ZEFP	DCON	LF	LH	APMX		Sıkma Vidası Screw Зажимной винт	Tork Anahtar Torx Key Торх Ключ	
AEM90-LN1006-D16-W16-L120-Z01-H	●	16	1	16	120	30	9	LN.X 1006..			
AEM90-LN1006-D16-W16-L150-Z01	●	16	1	16	150	50	9				
AEM90-LN1006-D18-W16-L120-Z02-H	●	18	2	16	120	30	9				
AEM90-LN1006-D20-W20-L120-Z02-H	●	20	2	20	120	30	9				
AEM90-LN1006-D20-W20-L150-Z02	●	20	2	20	150	50	9				
AEM90-LN1006-D25-W25-L120-Z03-H	●	25	3	25	120	30	9				
AEM90-LN1006-D25-W25-L150-Z03	●	25	3	25	150	50	9				
AEM90-LN1006-D32-W32-L120-Z04-H	●	32	4	32	120	30	9				
AEM90-LN1006-D32-W32-L150-Z04	●	32	4	32	150	50	9				

R: Sağ / Right / Правый L: Sol / Left / Левый
● Stokta / In Stock / В наличии ○ Stokta Yok / Non Stock Item / Нет в наличии
KRYL Ucuna Uygundur. / Compatible with KRYL Insert. / Под пластину KRYL

Sipariş Örneği/Ordering Example/Образец заказа
1 ad./pcs./шт. AEM90-LN15T6-D25-W25-L150-Z02-H
Kesme Hesabı : S 377/ Cutting Calculation : P 377 / Расчет режимов резания: стр. 377

S-SİSTEM YÜZEY PARMAK FREZELER
S-SYSTEM END MILLS
S-ТИП КОНЦЕВЫЕ ФРЕЗЫ

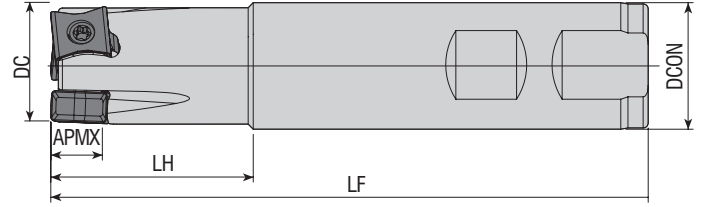

Takım Kodu Ordering Code Код для заказа	Stok Stock Наличие	Takım Ölçüleri (mm) Dimension (mm) Размеры (мм)						Kesici Uç Insert Пластина	Yedek Parçaları / Spare Parts / Запасные части	
		DC	ZEFP	DCON	LF	LH	APMX		Sıkma Vidası Screw Зажимной винт	Tork Anahtar Torx Key Торх Ключ
AEM90-LN1106-D25-W25-L150-Z03	●	25	3	25	150	40	10	LNMT 1106..	4015-M3.5x11	80-T15
AEM90-LN1106-D32-W32-L150-Z04	●	32	4	32	150	40	10			
AEM90-LN1106-D40-W32-L150-Z05	●	40	5	32	150	40	10			

ISCR-XTC-GSC Ucuna Uygunudur. / Compatible with ISCR-XTC-GSC Insert. / Под пластину ISCR-XTC-GSC.

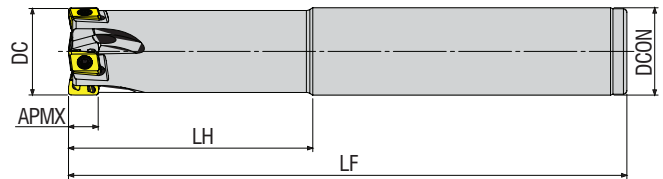

Takım Kodu Ordering Code Код для заказа	Stok Stock Наличие	Takım Ölçüleri (mm) Dimension (mm) Размеры (мм)						Kesici Uç Insert Пластина	Yedek Parçaları / Spare Parts / Запасные части			
		DC	ZEFP	DCON	LF	LH	APMX		Sıkma Vidası Screw Зажимной винт	Tork Anahtar Torx Key Торх Ключ		
AEM90-L009-D16-C16-L160-Z02-H	○	16	2	16	160	60	8	LOGU 0904..	1110-M3x8.5	82-T08		
AEM90-L009-D18-C16-L160-Z02-H	○	18	2	16	160	25	8					
AEM90-L009-D20-C20-L160-Z03-H	○	20	3	20	160	60	8					
AEM90-L009-D20-W20-L100-Z03-H	●	20	3	20	100	30	8					
AEM90-L009-D22-C20-L160-Z03-H	○	22	3	20	160	30	8					
AEM90-L009-D25-C25-L160-Z04-H	○	25	4	25	160	70	8					
AEM90-L009-D25-W25-L091-Z03-H	●	25	3	25	91	30	8				3007-M2.7x8	82-T07
AEM90-L009-D32-C32-L160-Z05-H	●	32	5	32	160	70	8					

R: Sağ / Right / Правый L: Sol / Left / Левый

● Stokta / In Stock / В наличии ○ Stokta Yok / Non Stock Item / Нет в наличии

MTSBH Ucuna Uygunudur. / Compatible with MTSBH Insert. / Под пластину MTSBH.

Sipariş Örneği/Ordering Example/Образец заказа

1 ad./pcs./шт. AEM90-LN1106-D25-W25-L150-Z03

Kesme Hesabı : S 377 / Cutting Calculation : P 377 / Расчет режимов резания: стр. 377



KAPR=90°

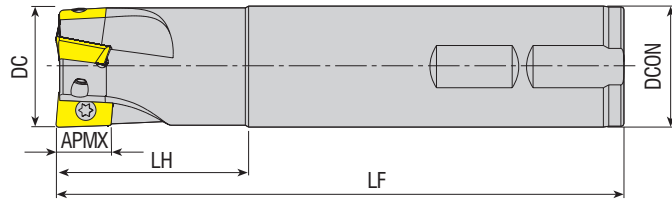

Takım Kodu Ordering Code Код для заказа	Stok Stock Наличие	Takım Ölçüleri (mm) Dimension (mm) Размеры (мм)						Kesici Uç Insert Пластина	Yedek Parçaları / Spare Parts / Запасные части	
		DC	ZEFP	DCON	LF	LH	APMX		Sıkma Vidası Screw Зажимной винт	Tork Anahtar Torx Key Торх Ключ
AEM90-L010-D16-W16-L100-Z02	●	16	2	16	100	30	10	LOMU 1004..		82-T08
AEM90-L010-D16-W16-L160-Z02	●	16	2	16	160	50	10			
AEM90-L010-D20-W20-L130-Z03	●	20	3	20	130	40	10			
AEM90-L010-D25-W25-L150-Z03	●	25	3	25	150	50	10			
AEM90-L010-D32-W32-L150-Z04	●	32	4	32	150	50	10			

KYCR Ucuna Uygunudur. / Compatible with KYCR Insert. / Под пластину KYCR.

KAPR=90°

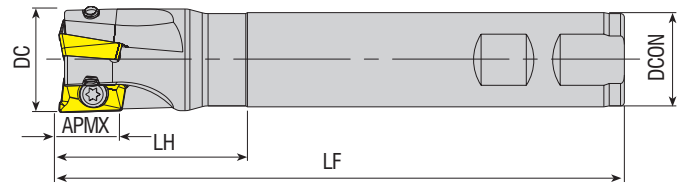

Takım Kodu Ordering Code Код для заказа	Stok Stock Наличие	Takım Ölçüleri (mm) Dimension (mm) Размеры (мм)						Kesici Uç Insert Пластина	Yedek Parçaları / Spare Parts / Запасные части	
		DC	ZEFP	DCON	LF	LH	APMX		Sıkma Vidası Screw Зажимной винт	Tork Anahtar Torx Key Торх Ключ
AEM90-R390.11-D12-W12-L100-Z01	●	12	1	12	100	25	10	R390-11T3..		82-T08
AEM90-R390.11-D16-W16-L100-Z02-H	●	16	2	16	100	30	10			
AEM90-R390.11-D16-W16-L150-Z02	●	16	2	16	150	50	10			
AEM90-R390.11-D16-W16-L150-Z02-H	●	16	2	16	150	50	10			
AEM90-R390.11-D20-W20-L090-Z02-H	●	20	2	20	90	30	10			
AEM90-R390.11-D20-W20-L100-Z03-H	●	20	3	20	100	30	10			
AEM90-R390.11-D20-W20-L150-Z03	●	20	3	20	150	50	10			
AEM90-R390.11-D20-W20-L150-Z03-H	●	20	3	20	150	50	10			
AEM90-R390.11-D20-C20-L150-Z03	●	20	3	20	150	30	10			
AEM90-R390.11-D22-W20-L090-Z02-H	●	22	2	20	90	30	10			
AEM90-R390.11-D25-C20-L150-Z03	●	25	3	20	150	40	10			
AEM90-R390.11-D25-W25-L100-Z03-H	●	25	3	25	100	30	10			
AEM90-R390.11-D25-W25-L150-Z03	●	25	3	25	150	50	10			
AEM90-R390.11-D25-W25-L150-Z03-H	●	25	3	25	150	50	10			
AEM90-R390.11-D30-W25-L150-Z04-H	●	30	4	25	150	30	10			
AEM90-R390.11-D32-C25-L200-Z03	●	32	3	25	200	40	10			
AEM90-R390.11-D32-W32-L150-Z05-H	●	32	5	32	150	50	10			
AEM90-R390.17-D25-W25-L150-Z02	●	25	2	25	150	50	15.4	R390-1704..		80-T15
AEM90-R390.17-D25-W25-L150-Z02-H	●	25	2	25	150	50	15.4			
AEM90-R390.17-D30-W25-L150-Z03	●	30	3	25	150	40	15.4			
AEM90-R390.17-D30-W25-L150-Z03-H	●	30	3	25	150	40	15.4			
AEM90-R390.17-D32-W32-L150-Z03-H	●	32	3	32	150	40	15.4			
AEM90-R390.18-D32-C32-L150-Z03	●	32	3	32	150	45	15.4	R390-1806..		
AEM90-R390.18-D40-C32-L150-Z04-H	●	40	4	32	150	40	15.4			

R: Sağ / Right / Правый L: Sol / Left / Левый

● Stokta / In Stock / В наличии ○ Stokta Yok / Non Stock Item / Нет в наличии

SNDVK Ucuna Uygunudur. / Compatible with SNDVK Insert. / Под пластину SNDVK

Sipariş Örneği/Ordering Example/Образец заказа

1 ad./pcs./шт. AEM90-L010-D16-W16-L100-Z02

Kesme Hesabı : S 377/ Cutting Calculation : P 377 / Расчет режимов резания: стр. 377

S-SİSTEM YÜZEY PARMAK FREZELER

S-SYSTEM END MILLS

S-ТИП КОНЦЕВЫЕ ФРЕЗЫ

KAPR=90°

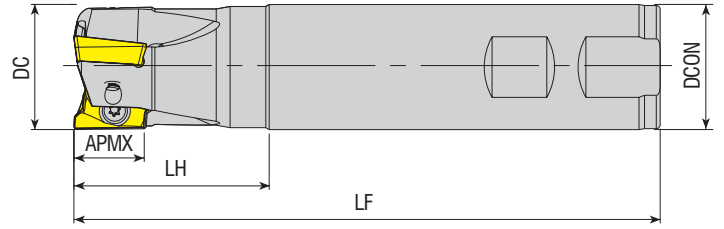

Takım Kodu
Ordering Code
Код для заказа

Stok
Stock
Наличие

Takım Ölçüleri (mm)
Dimension (mm)
Размеры (мм)

Kesici Uç
Insert
Пластина

Yedek Parçaları / Spare Parts / Запасные части

Sıkma Vidası
Screw
Зажимной винт

Tork Anahtar
Torx Key
Торх Ключ

Takım Kodu Ordering Code Код для заказа	Stok Stock Наличие	DC	ZEFP	DCON	LF	LH	APMX	Kesici Uç Insert Пластина	Yedek Parçaları / Spare Parts / Запасные части				
									Sıkma Vidası Screw Зажимной винт	Tork Anahtar Torx Key Торх Ключ			
AEM90-RT07-D10-W10-L120-Z02	●	10	2	10	120	30	7	RT 0702	3006-M2x4	82-T06			
AEM90-RT07-D12-C12-L120-Z02	●	12	2	12	120	30	7						
AEM90-RT07-D12-W12-L120-Z02	●	12	2	12	120	30	7						
AEM90-RT07-D14-W12-L120-Z02	●	14	2	12	120	30	7						
AEM90-RT10-D16-C15-L160-Z02	●	16	2	15	160	30	10						
AEM90-RT10-D16-W16-L120-Z02-H	●	16	2	16	120	30	10						
AEM90-RT10-D16-W16-L150-Z02	●	16	2	16	150	30	10						
AEM90-RT10-D16-C16-L200-Z02	●	16	2	16	200	100	10						
AEM90-RT10-D17-W16-L160-Z02	●	17	2	16	160	30	10						
AEM90-RT10-D17-C16-L200-Z02	●	17	2	16	200	30	10						
AEM90-RT10-D18-W16-L120-Z02-H	●	18	2	16	120	30	10	RT 1003	3008-M2.5x6	82-T08			
AEM90-RT10-D20-C19-L200-Z03	●	20	3	19	200	30	10						
AEM90-RT10-D20-C20-L110-Z03	●	20	3	20	110	30	10						
AEM90-RT10-D20-W20-L120-Z03-H	●	20	3	20	120	30	10						
AEM90-RT10-D20-W20-L150-Z03	●	20	3	20	150	50	10						
AEM90-RT10-D20-C20-L200-Z03	●	20	3	20	200	100	10						
AEM90-RT10-D21-W20-L200-Z03	●	21	3	20	200	30	10						
AEM90-RT10-D22-W20-L120-Z03-H	●	22	3	20	120	30	10						
AEM90-RT10-D22-C20-L150-Z03	●	22	3	20	150	30	10						
AEM90-RT10-D22-C20-L200-Z03	●	22	3	20	200	30	10						
AEM90-RT10-D25-W25-L120-Z04-H	●	25	4	25	120	40	10						
AEM90-RT10-D25-W25-L150-Z04	●	25	4	25	150	50	10						
AEM90-RT10-D25-C25-L200-Z04	●	25	4	25	200	100	10						
AEM90-RT10-D26-C25-L250-Z04	●	26	4	25	250	32	10						
AEM90-RT10-D32-W32-L120-Z05-H	●	32	5	32	120	50	10						
AEM90-RT10-D32-W32-L150-Z05	●	32	5	32	150	50	10						
AEM90-RT10-D32-C32-L200-Z05	●	32	5	32	200	100	10						
AEM90-RT10-D33-C32-L250-Z04	●	33	4	32	250	32	10	RT 1304	3008-M3x8				
AEM90-RT13-D32-C32-L250-Z04	●	32	4	32	250	50	13						
AEM90-RT16-D25-W25-L120-Z02-H	●	25	2	25	120	40	16	RT 1606	4015-M4x9	80-T15			
AEM90-RT16-D25-W25-L150-Z02	●	25	2	25	150	50	16						
AEM90-RT16-D25-C25-L200-Z02	●	25	2	25	200	100	16						
AEM90-RT16-D32-W32-L120-Z03-H	●	32	3	32	120	50	16						
AEM90-RT16-D32-W32-L150-Z03	●	32	3	32	150	50	16						
AEM90-RT16-D32-C32-L200-Z03	●	32	3	32	200	100	16						
AEM90-RT16-D32-C32-L250-Z03	●	32	3	32	250	100	16						
AEM90-RT16-D32-C32-L270-Z03	●	32	3	32	270	100	16						
AEM90-RT16-D40-W32-L120-Z04-H	●	40	4	32	120	50	16						
AEM90-RT16-D40-W32-L150-Z04	●	40	4	32	150	50	16						
AEM90-RT16-D40-C32-L200-Z04	●	40	4	32	200	100	16						
												4015-M4x11	

R: Sağ / Right / Правый L: Sol / Left / Левый

● Stokta / In Stock / В наличии ○ Stokta Yok / Non Stock Item / Нет в наличии
SFTY Ucuna Uygundur. / Compatible with SFTY Insert. / Под пластину SFTY

Sipariş Örneği/Ordering Example/Образец заказа

1 ad./pcs./шт. AEM90-RT07-D10-W10-L120-Z02

Kesme Hesabı : S 377 / Cutting Calculation : P 377 / Расчет режимов резания: стр. 377



www.akkо.com.tr

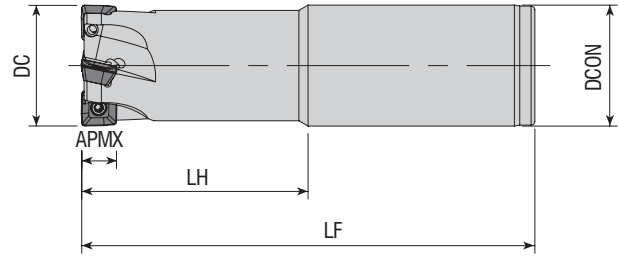

Takım Kodu Ordering Code Код для заказа	Stok Stock Наличие	Takım Ölçüleri (mm) Dimension (mm) Размеры (мм)						Kesici Uç Insert Пластина	Yedek Parçaları / Spare Parts / Запасные части		
		DC	ZEFP	DCON	LF	LH	APMX		Sıkma Vidası Screw Зажимной винт	Tork Anahtar Torx Key Торх Ключ	
AEM90-SE09-D25-C25-L120-Z03-H	●	25	3	25	120	60	6.7	SEET 09T3..		3008-M3x8	
AEM90-SE09-D25-C25-L150-Z02	●	25	2	25	150	50	6.7				
AEM90-SE09-D32-C32-L120-Z04-H	●	32	4	32	120	60	6.7				
AEM90-SE09-D32-C32-L150-Z03	●	32	3	32	150	50	6.7				

ZCC Ucuna Uygunudur. / Compatible with ZCC Insert. / Под пластину ZCC

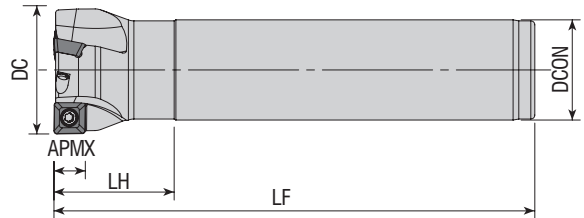

Takım Kodu Ordering Code Код для заказа	Stok Stock Наличие	Takım Ölçüleri (mm) Dimension (mm) Размеры (мм)						Kesici Uç Insert Пластина	Yedek Parçaları / Spare Parts / Запасные части		
		DC	ZEFP	DCON	LF	LH	APMX		Sıkma Vidası Screw Зажимной винт	Tork Anahtar Torx Key Торх Ключ	
AEM90-S00803-D20-C16-L110-Z02-H	●	20	2	16	110	25	7	SOMT 0803..		3008-M3x7	
AEM90-S00803-D25-C20-L110-Z02-H	●	25	2	20	110	25	7				
AEM90-S00803-D32-C25-L120-Z03-H	●	32	3	25	120	30	7				

R: Sağ / Right / Правый L: Sol / Left / Левый

● Stokta / In Stock / В наличии ○ Stokta Yok / Non Stock Item / Нет в наличии
SMTM Ucuna Uygunudur. / Compatible with SMTM Insert. / Под пластину SMTM.

Sipariş Örneği/Ordering Example/Образец заказа

1 ad./pcs./шт. AEM90-SE09-D25-C25-L120-Z03-H

Kesme Hesabı : S 377/ Cutting Calculation : P 377 / Расчет режимов резания: стр. 377

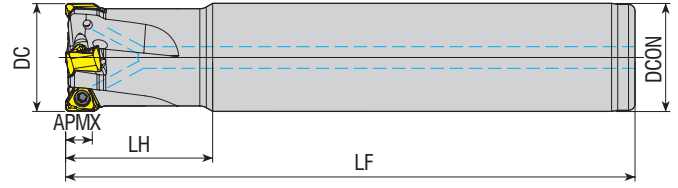

Takım Kodu Ordering Code Код для заказа	Stok Stock Наличие	Takım Ölçüleri (mm) Dimension (mm) Размеры (мм)						Kesici Uç Insert Пластина	Yedek Parçaları / Spare Parts / Запасные части		
		DC	ZAFP	DCON	LF	LH	APMX		Sıkma Vidası Screw Зажимной винт	Tork Anahtar Torx Key Торк Ключ	
new AEM90-TNG10-D20-W20-L90-Z02-H	●	20	2	20	90	32	5	TNGX 1004..	3008-M2.5x6	82-T08	
new AEM90-TNG10-D20-W20-L90-Z03-H	●	20	3	20	90	32	5				
AEM90-TNG10-D20-C20-L125-Z02-H	●	20	2	20	125	29	5				
AEM90-TNG10-D20-C20-L125-Z03-H	●	20	3	20	125	29	5				
AEM90-TNG10-D20-C20-L150-Z03-H	●	20	3	20	150	50	5				
AEM90-TNG10-D21-C20-L200-Z03-H	●	21	3	20	200	30	5				
AEM90-TNG10-D25-C25-L150-Z03-H	●	25	3	25	100	42	5				
new AEM90-TNG10-D25-W25-L100-Z03-H	●	25	4	25	100	42	5				
new AEM90-TNG10-D25-W25-L100-Z04-H	●	25	3	25	150	34	5				
AEM90-TNG10-D25-C25-L150-Z04-H	●	25	4	25	150	34	5				
AEM90-TNG10-D25-C25-L170-Z04-H	●	25	4	25	170	50	5				
AEM90-TNG10-D26-C25-L250-Z04-H	●	26	4	25	250	35	5				
new AEM90-TNG10-D28-W25-L100-Z04-H	●	28	4	25	100	29	5				
new AEM90-TNG10-D32-W32-L110-Z04-H	●	32	4	32	110	42	5				
new AEM90-TNG10-D32-W32-L110-Z05-H	●	32	5	32	110	42	5				
AEM90-TNG10-D32-C32-L170-Z04-H	●	32	4	32	170	37	5				
AEM90-TNG10-D32-C32-L170-Z05-H	●	32	5	32	170	37	5				
AEM90-TNG10-D33-C32-L250-Z05-H	●	33	5	32	250	35	5				
AEM90-TNG16-D25-C25-L170-Z02-H	●	25	2	25	170	34	10	TNGX 1606..	3015-M4x11	80-T15	
AEM90-TNG16-D25-C25-L170-Z02-H-80	●	25	2	25	170	80	10				
AEM90-TNG16-D25-W25-L110-Z02-H	●	25	2	25	110	42	10				
AEM90-TNG16-D32-C32-L195-Z02-H	●	32	2	32	195	34	10				
AEM90-TNG16-D32-C32-L195-Z02-H-80	●	32	2	32	195	80	10				
AEM90-TNG16-D32-C32-L195-Z03-H	●	32	3	32	195	34	10				
AEM90-TNG16-D32-W32-L110-Z03-H	●	32	3	32	110	42	10				
AEM90-TNG16-D35-C32-L195-Z04-H	●	35	4	32	195	34	10				
AEM90-TNG16-D40-W32-L120-Z04-H	●	40	4	32	120	50	10				

R: Sağ / Right / Правый L: Sol / Left / Левый
● Stokta / In Stock / В наличии ○ Stokta Yok / Non Stock Item / Нет в наличии
PRMT Ucuna Uygunudur. / Compatible with PRMT Insert. / Под пластину PRMT.

Sipariş Örneği/Ordering Example/Образец заказа
1 ad./pcs./шт. AEM90-TNG10-D20-W20-L90-Z02-H
Kesme Hesabı : S 377/ Cutting Calculation : P 377 / Расчет режимов резания: стр. 377

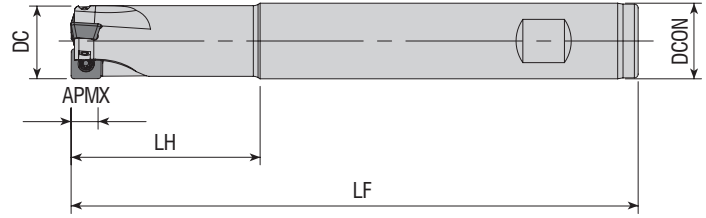

Takım Kodu Ordering Code Код для заказа	Stok Stock Наличие	Takım Ölçüleri (mm) Dimension (mm) Размеры (мм)						Kesici Uç Insert Пластина	Yedek Parçaları / Spare Parts / Запасные части		
		DC	ZEPF	DCON	LF	LH	APMX		Sıkma Vidası Screw Зажимной винт	Tork Anahtar Torx Key Торх Ключ	
AEM90-SPGT0602-D16-W16-L150-Z02	●	16	2	16	150	50	5.5		3007-M2.2x4.6	82-T07	
AEM90-SPGT07T3-D20-W20-L150-Z03	●	20	3	20	150	50	7		3008-M2.5x6	82-T08	
AEM90-SPGT07T3-D25-W25-L150-Z03	●	25	3	25	150	50	7		3008-M2.5x6	82-T08	
AEM90-SPGT0904-D30-W32-L150-Z03	●	30	3	32	150	50	9		4015-M3.5x9	80-T15	

ZCC Ucuna Uygunur. / Compatible with ZCC Insert. / Под пластину ZCC

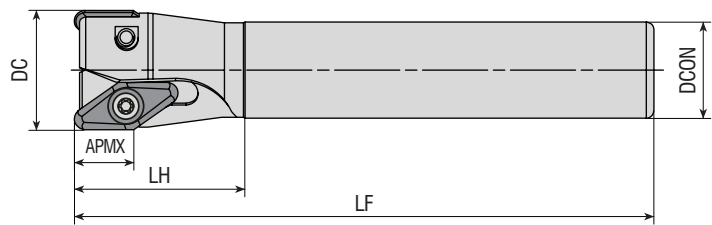

Takım Kodu Ordering Code Код для заказа	Stok Stock Наличие	Takım Ölçüleri (mm) Dimension (mm) Размеры (мм)						Kesici Uç Insert Пластина	Yedek Parçaları / Spare Parts / Запасные части		
		DC	ZEPF	DCON	LF	LH	APMX		Sıkma Vidası Screw Зажимной винт	Tork Anahtar Torx Key Торх Ключ	
AEM90-VC2205-D32-C25-L150-Z02-H	●	32	2	25	150	50	15		4015-M4.5x11	80-T15	
AEM90-VC2205-D40-C32-L150-Z03-H	●	40	3	32	150	50	15		4015-M4.5x11	80-T15	

R: Sağ / Right / Правый L: Sol / Left / Левый
● Stokta / In Stock / В наличии ○ Stokta Yok / Non Stock Item / Нет в наличии
ISO Ucuna Uygunur. / Compatible with ISO Insert. / Под пластину ISO.

Sipariş Örneği/Ordering Example/Образец заказа
1 ad./pcs./шт. AEM90-SPGT0602-D16-W16-L150-Z02
Kesme Hesabı : S 377 / Cutting Calculation : P 377 / Расчет режимов резания: стр. 377

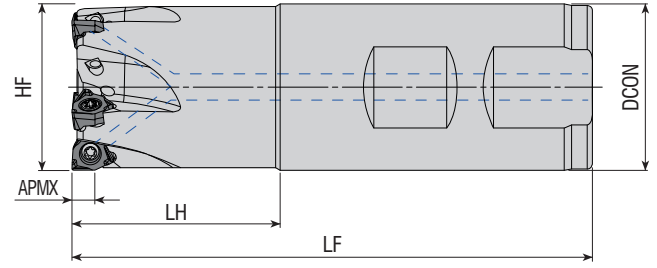

Takım Kodu Ordering Code Код для заказа	Stok Stock Наличие	Takım Ölçüleri (mm) Dimension (mm) Размеры (мм)						Kesici Uç Insert Пластина	Yedek Parçaları / Spare Parts / Запасные части		
		DC	ZEFP	DCON	LF	LH	APMX		Sıkma Vidası Screw Зажимной винт	Tork Anahtar Torx Key Торх Ключ	
new AEM90-WNG04-D20-W20-L81-Z02-H	●	20	2	20	81	31	4	WNGU 0403..	3008-M3x6	82-T08	
AEM90-WNG04-D20-W20-L81-Z03-H	●	20	3	20	81	31	4				
new AEM90-WNG04-D20-C20-L170-Z02-H	●	20	2	20	170	50	4				
AEM90-WNG04-D20-C20-L170-Z03-H	●	20	3	20	170	50	4				
AEM90-WNG04-D25-W25-L88-Z03-H	●	25	3	25	88	32	4				
AEM90-WNG04-D25-W25-L88-Z04-H	●	25	4	25	88	32	4				
new AEM90-WNG04-D25-C25-L170-Z02-H	●	25	2	25	170	50	4				
AEM90-WNG04-D25-C25-L170-Z03-H	●	25	3	25	170	50	4				
AEM90-WNG04-D32-W25-L100-Z05-H	●	32	5	25	100	35	4				
AEM90-WNG04-D32-W32-L100-Z05-H	●	32	5	32	100	40	4				
new AEM90-WNG04-D32-C32-L170-Z03-H	●	32	3	32	170	50	4	WNGU 0806..	4015-M4x11	80-T15	
AEM90-WNG04-D32-C25-L170-Z04-H	●	32	4	25	170	35	4				
AEM90-WNG04-D32-C32-L170-Z04-H	●	32	4	32	170	50	4				
new AEM90-WNG08-D32-C32-L170-Z02-H	●	32	2	32	170	50	7.5				
AEM90-WNG08-D40-W32-L100-Z03-H	●	40	3	32	100	35	7.5				
new AEM90-WNG08-D40-W40-L110-Z03-H	●	40	3	40	110	40	7.5	WNGU 0806..	4015-M4x11	80-T15	
AEM90-WNG08-D40-C32-L170-Z03-H	●	40	3	32	170	35	7.5				

XTC-GSC Ucuna Uygunudur. / Compatible with XTC-GSC Insert. / Под пластину XTC-GSC

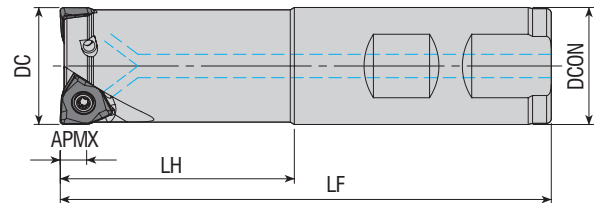





Takım Kodu Ordering Code Код для заказа	Stok Stock Наличие	Takım Ölçüleri (mm) Dimension (mm) Размеры (мм)						Kesici Uç Insert Пластина	Yedek Parçaları / Spare Parts / Запасные части		
		DC	ZEFP	DCON	LF	LH	APMX		Sıkma Vidası Screw Зажимной винт	Tork Anahtar Torx Key Торх Ключ	
AEM90L-WN0604Z-D25-C25-L200-Z02-H	●	25	2	25	200	100	5.7	WNHU 0604..	3008-M3x8	82-T08	
AEM90-WN0604Z-D25-W25-L150-Z02-H	●	25	2	25	150	50	5.7				
AEM90-WN0604Z-D32-W32-L150-Z03-H	●	32	3	32	150	50	5.7				
AEM90-WN0604Z-D40-W32-L150-Z04-H	●	40	4	32	150	35	5.7				

R: Sağ / Right / Правый L: Sol / Left / Левый
● Stokta / In Stock / В наличии ○ Stokta Yok / Non Stock Item / Нет в наличии
ZCC Ucuna Uygunudur. / Compatible with ZCC Insert. / Под пластину ZCC

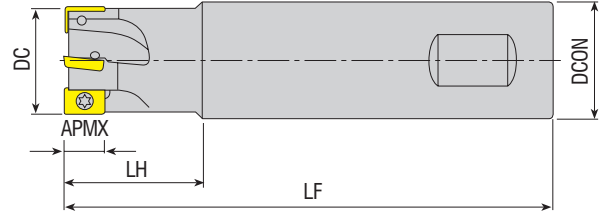
Sipariş Örneği/Ordering Example/Образец заказа
1 ad./pcs./шт. AEM90-WNG04-D20-W20-L81-Z02-H



Kesme Hesabı : S 377/ Cutting Calculation : P 377 / Расчет режимов резания: стр. 377

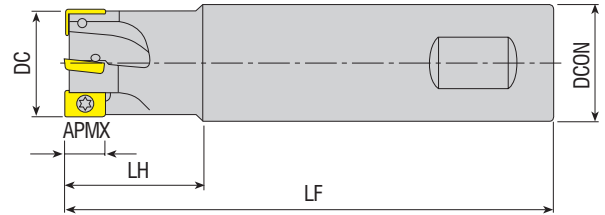

Takım Kodu Ordering Code Код для заказа	Stok Stock Наличие	Takım Ölçüleri (mm) Dimension (mm) Размеры (мм)						Kesici Uç Insert Пластина	Yedek Parçaları / Spare Parts / Запасные части		
		DC	ZEFP	DCON	LF	LH	APMX		Sıkma Vidası Screw Зажимной винт	Tork Anahtar Torx Key Торх Ключ	
AEM90-XD11T3-D16-W16-L150-Z02	●	16	2	16	150	30	10				
AEM90-XD11T3-D17-C16-L150-Z02	●	17	2	16	150	30	10				
AEM90-XD11T3-D20-W20-L150-Z03	●	20	3	20	150	50	10				
AEM90-XD11T3-D21-C20-L080-Z03-H	●	21	3	20	80	25	10		XD.T 11T3..	3008-M2.5x6	82-T08
AEM90-XD11T3-D21-C20-L150-Z03	●	21	3	20	150	30	10				
AEM90-XD11T3-D25-W25-L150-Z04	●	25	4	25	150	50	10				
AEM90-XD11T3-D30-W25-L120-Z04	●	30	4	25	120	30	10				
AEM90-XD11T3-D32-W32-L150-Z04	●	32	4	32	150	50	10				
AEM90-XD11T3-D33-C20-L080-Z04-H	●	33	4	20	80	30	10				

CRTZT Ucuna Uygundur. / Compatible with CRTZT Insert. / Под пластину CRTZT



Takım Kodu Ordering Code Код для заказа	Stok Stock Наличие	Takım Ölçüleri (mm) Dimension (mm) Размеры (мм)						Kesici Uç Insert Пластина	Yedek Parçaları / Spare Parts / Запасные части	
		DC	ZEFP	DCON	LF	LH	APMX		Sıkma Vidası Screw Зажимной винт	Tork Anahtar Torx Key Торх Ключ
AEM90-XC13-D20-W20-L150-Z02	●	20	2	20	150	60	13			
AEM90-XC13-D25-W25-L150-Z03	●	25	3	25	150	60	13			
AEM90-XC13-D32-W32-L150-Z04	●	32	4	32	150	60	13		XCX 13T3..	3008-M3x8

R: Sağ / Right / Правый L: Sol / Left / Левый

● Stokta / In Stock / В наличии ○ Stokta Yok / Non Stock Item / Нет в наличии
SC Ucuna Uygundur. / Compatible with SC Insert. / Под пластину SC

Sipariş Örneği/Ordering Example/Образец заказа

1 ad./pcs./шт. AEM90-XD11T3-D16-W16-L150-Z02

Kesme Hesabı : S 377 / Cutting Calculation : P 377 / Расчет режимов резания: стр. 377

S-SİSTEM YÜZEY PARMAK FREZELER

S-SYSTEM END MILLS

S-ТИП КОНЦЕВЫЕ ФРЕЗЫ

KAPR=90°

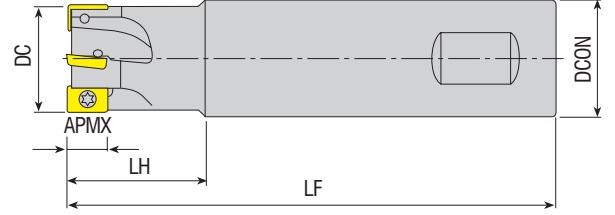

Takım Kodu Ordering Code Код для заказа	Stok Stock Наличие	Takım Ölçüleri (mm) Dimension (mm) Размеры (мм)						Kesici Uç Insert Пластина	Yedek Parçaları / Spare Parts / Запасные части		
		DC	ZEFP	DCON	LF	LH	APMX		Sıkma Vidası Screw Зажимной винт	Tork Anahtar Torx Key Торх Ключ	
AEM90-X006-D10-C12-L120-Z02	●	10	2	12	120	50	5	XO.. 0602..	3006-M1.8x4	82-T06	
AEM90-X006-D12-C12-L120-Z02	●	12	2	12	120	25	5				
AEM90-X009-D16-W16-L150-Z02	●	16	2	16	150	50	8	XO.. 0903..	3008-M2.5x5	82-T08	
AEM90-X009-D20-W20-L150-Z03	●	20	3	20	150	50	8				
AEM90-X012-D20-W20-L150-Z02	●	20	2	20	150	50	11	XO.. 1204..	3010-M3.5x7	82-T10	
AEM90-X012-D20-C20-L200-Z02	●	20	2	20	200	100	11				
AEM90-X012-D22-W20-L150-Z02	●	22	2	20	150	30	11				
AEM90-X012-D25-W25-L150-Z03	●	25	3	25	150	50	11				
AEM90-X012-D25-C25-L200-Z03	●	25	3	25	200	100	11				
AEM90-X012-D32-C25-L150-Z04	●	32	4	25	150	40	11				
AEM90-X012-D32-W32-L150-Z04	●	32	4	32	150	50	11				
AEM90-X012-D32-C32-L250-Z04	●	32	4	32	250	100	11				

SC Ucuna Uygundur. / Compatible with SC Insert. / Под пластину SC

KAPR=90°

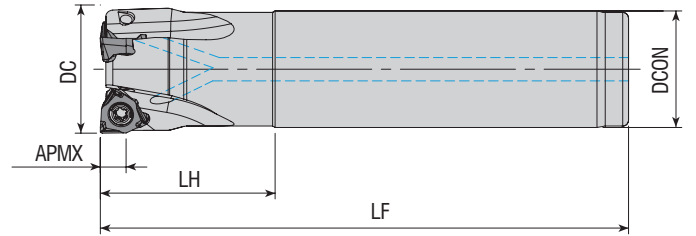

Takım Kodu Ordering Code Код для заказа	Stok Stock Наличие	Takım Ölçüleri (mm) Dimension (mm) Размеры (мм)						Kesici Uç Insert Пластина	Yedek Parçaları / Spare Parts / Запасные части		
		DC	ZEFP	DCON	LF	LH	APMX		Sıkma Vidası Screw Зажимной винт	Tork Anahtar Torx Key Торх Ключ	
AEM90-XN0403-D16-C16-L100-Z01-H	●	16	1	16	100	30	4	XNEX 0403..	3008-M2.5x6	82-T08	
AEM90-XN0403-D22-C20-L110-Z03-H	●	22	3	20	110	30	4				
AEM90-XN0806-D32-C32-L110-Z02-H	●	32	2	32	110	40	7.5	XNEX 0806..	4015-M4x11	80-T15	

R: Sağ / Right / Правый L: Sol / Left / Левый

● Stokta / In Stock / В наличии ○ Stokta Yok / Non Stock Item / Нет в наличии

SC Ucuna Uygundur. / Compatible with SC Insert. / Под пластину SC

Sipariş Örneği/Ordering Example/Образец заказа

1 ad./pcs./шт. AEM90-X006-D10-C12-L120-Z02

Kesme Hesabı : S 377/ Cutting Calculation : P 377 / Расчет режимов резания: стр. 377

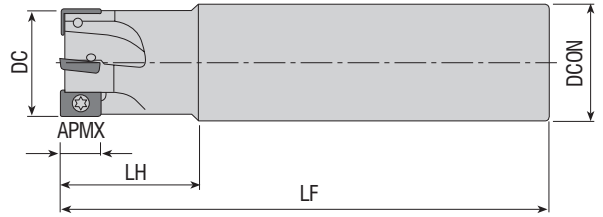

Takım Kodu Ordering Code Код для заказа	Stok Stock Наличие	Takım Ölçüleri (mm) Dimension (mm) Размеры (мм)						Kesici Uç Insert Пластина	Yedek Parçaları / Spare Parts / Запасные части		
		DC	ZEPF	DCON	LF	LH	APMX		Sıkma Vidası Screw Зажимной винт	Tork Anahtar Torx Key Торх Ключ	
AEM90-ZC1003-D16-C14-L150-Z02	●	16	2	14	150	25	9	ZCMT 100308R	3008-M2.5x6	82-T08	
AEM90-ZC1003-D16-C14-L200-Z02	●	16	2	14	200	25	9				
AEM90-ZC1003-D16-C15-L150-Z02	●	16	2	15	150	25	9				
AEM90-ZC1003-D16-C16-L150-Z02	●	16	2	16	150	25	9				
AEM90-ZC1003-D16-C16-L200-Z02	●	16	2	16	200	50	9				
AEM90-ZC1003-D17-C16-L150-Z02	●	17	2	16	150	25	9				
AEM90-ZC1003-D17-C16-L200-Z02	●	17	2	16	200	25	9				
AEM90-ZC1003-D20-C18-L150-Z03	●	20	3	18	150	25	9				
AEM90-ZC1003-D20-C18-L200-Z02	●	20	2	18	200	25	9				
AEM90-ZC1003-D20-C20-L150-Z03	●	20	3	20	150	40	9				
AEM90-ZC1003-D20-C18-L200-Z03	●	20	3	18	200	25	9				
AEM90-ZC1003-D21-C20-L150-Z02	●	21	2	20	150	30	9				
AEM90-ZC1003-D21-C20-L150-Z03	●	21	3	20	150	30	9				
AEM90-ZC1003-D21-C20-L200-Z03	●	21	3	20	200	30	9				
AEM90-ZC1003-D25-C20-L150-Z03	●	25	3	20	150	30	9				
AEM90-ZC1003-D25-C20-L200-Z03	●	25	3	20	200	30	9				
AEM90-ZC1003-D25-C25-L150-Z03	●	25	3	25	150	40	9				
AEM90-ZC1003-D26-C25-L170-Z03	●	26	3	25	170	25	9				
AEM90-ZC1003-D26-C25-L200-Z03	●	26	3	25	200	25	9				
AEM90-ZC1003-D32-C25-L180-Z04	●	32	4	25	180	30	9				
AEM90-ZC1003-D33-C32-L200-Z04	●	33	4	32	200	25	9				

DJT Ucuna Uygundur. / Compatible with DJT Insert. / Под пластину DJT

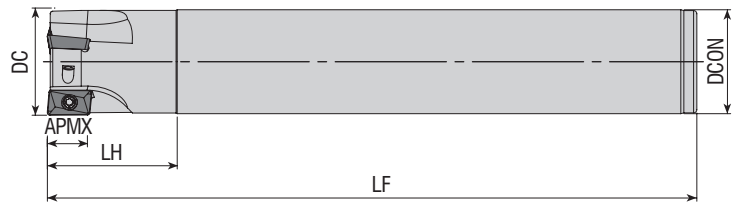

Takım Kodu Ordering Code Код для заказа	Stok Stock Наличие	Takım Ölçüleri (mm) Dimension (mm) Размеры (мм)						Kesici Uç Insert Пластина	Yedek Parçaları / Spare Parts / Запасные части		
		DC	ZEPF	DCON	LF	LH	APMX		Sıkma Vidası Screw Зажимной винт	Tork Anahtar Torx Key Торх Ключ	
AEM90-ZP13T3-D26-C25-L200-Z02	●	26	2	25	200	35	13	ZPMT 13T3..	4010-M3x8	82-T10	
AEM90-ZP13T3-D26-C25-L200-Z03	●	26	3	25	200	35	13				
AEM90-ZP13T3-D26-C25-L250-Z02	●	26	2	25	250	35	13				
AEM90-ZP13T3-D33-C32-L200-Z03	●	33	3	32	200	40	13				
AEM90-ZP13T3-D33-C32-L250-Z03	●	33	3	32	250	40	13				

R: Sağ / Right / Правый L: Sol / Left / Левый

● Stokta / In Stock / В наличии ○ Stokta Yok / Non Stock Item / Нет в наличии

DJT Ucuna Uygundur. / Compatible with DJT Insert. / Под пластину DJT

Sipariş Örneği/Ordering Example/Образец заказа

1 ad./pcs./шт. AEM90-ZC1003-D16-C14-L150-Z02

Kesme Hesabı : S 377/ Cutting Calculation : P 377 / Расчет режимов резания: стр. 377

S-SİSTEM YÜZEY PARMAK FREZELER

S-SYSTEM END MILLS

S-ТИП КОНЦЕВЫЕ ФРЕЗЫ

KAPR=90°

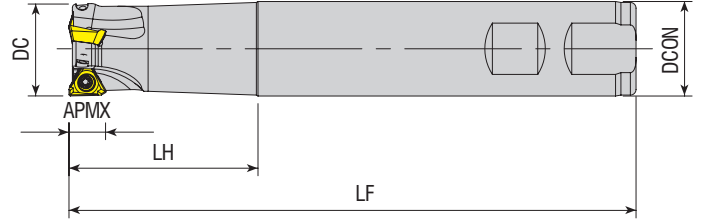

Takım Kodu Ordering Code Код для заказа	Stok Stock Наличие	Takım Ölçüleri (mm) Dimension (mm) Размеры (мм)						Kesici Uç Insert Пластина	Yedek Parçaları / Spare Parts / Запасные части		
		DC	ZEFP	DCON	LF	LH	APMX		Sıkma Vidası Screw Зажимной винт	Tork Anahtar Torx Key Торх Ключ	
new AEM90-3P0603-D12-C12-L120-Z01-H	●	12	1	12	120	25	4.7	3PKT 0603	3006-M2x4	82-T06	
AEM90-3P0603-D16-W16-L120-Z03-H	●	16	3	16	120	25	4.7				
AEM90-3P0603-D20-W20-L150-Z03-H	●	20	3	20	150	25	4.7				
AEM90-3P0603-D25-W25-L150-Z05-H	●	25	5	25	150	25	4.7				
AEM90-3P1004-D20-W20-L150-Z02	●	20	2	20	150	40	7	3PKT 1004	1108-M2.5x6	82-T08	
AEM90-3P1004-D21-C20-L200-Z02	●	21	2	20	200	30	7				
new AEM90-3P1004-D22-W20-L150-Z02	●	22	2	20	150	30	7	3PKT 1505	1115-M4x10	80-T15	
AEM90-3P1004-D25-W25-L150-Z03	●	25	3	25	150	40	7				
AEM90-3P1505-D32-W32-L150-Z03	●	32	3	32	150	50	11	3PKT 1505	1115-M4x10	80-T15	
AEM90-3P1505-D38-W32-L150-Z03	●	38	3	32	150	35	11				
AEM90-3P1505-D40-W32-L150-Z04	●	40	4	32	150	35	11				

TGTC Ucuna Uygun. / Compatible with TGTC Insert. / Под пластину TGTC.

KAPR=90°

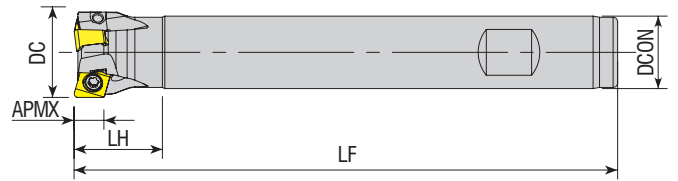

Takım Kodu Ordering Code Код для заказа	Stok Stock Наличие	Takım Ölçüleri (mm) Dimension (mm) Размеры (мм)						Kesici Uç Insert Пластина	Yedek Parçaları / Spare Parts / Запасные части		
		DC	ZEFP	DCON	LF	LH	APMX		Sıkma Vidası Screw Зажимной винт	Tork Anahtar Torx Key Торх Ключ	
AEM90-4N06-D16-W16-L120-Z02-H	●	16	2	16	120	25	6	4NKT 0603..	1108-M3x6.8	82-T08	
AEM90-4N06-D16-W16-L160-Z02	●	16	2	16	160	25	6				
AEM90-4N06-D20-W16-L120-Z03-H	●	20	3	16	120	20	6				
AEM90-4N06-D20-W16-L160-Z03	●	20	3	16	160	20	6				
new AEM90-4N06-D20-W20-L160-Z03	●	20	3	20	160	25	6				

TGTC Ucuna Uygun. / Compatible with TGTC Insert. / Под пластину TGTC.

R: Sağ / Right / Правый L: Sol / Left / Левый

● Stokta / In Stock / В наличии ○ Stokta Yok / Non Stock Item / Нет в наличии

Sipariş Örneği/Ordering Example/Образец заказа

1 ad./pcs./шт. AEM90-3P0603-D12-C12-L120-Z01-H

Kesme Hesabı : S 377/ Cutting Calculation : P 377 / Расчет режимов резания: стр. 377

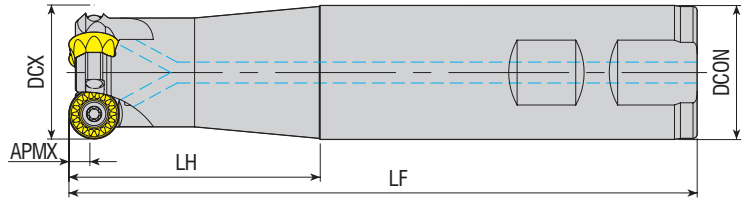

Takım Kodu Ordering Code Код для заказа	Stok Stock Наличие	Takım Ölçüleri (mm) Dimension (mm) Размеры (мм)						Kesici Uç Insert Пластина	Yedek Parçaları / Spare Parts / Запасные части			
		DCX	ZEFP	DCON	LF	LH	APMX		Sıkma Vidası Screw Зажимной винт	Baskı Parçası Wedge Clamp Прижим	Baskı Vidası Clamp Screw Зажимной винт	Tork Anahtar Torx Key Торх Ключ
AEMR-RP08T2M-D20-W20-L150-Z02-H	●	20	2	20	150	60	4	RPMT 08T2..	3008-M2.5x6	-	-	82-T08
AEMR-RP08T2M-D25-W25-L200-Z03-H	●	25	3	25	200	100	4					
AEMR-RP10T3M-D25-W25-L200-Z02-H	●	25	2	25	200	100	5	RPMT 10T3..	4015-M3.5x9	-	-	
AEMR-RP10T3M-D32-W32-L200-Z03-H	●	32	3	32	200	100	5					
new AEMR-RP1204M-D25-C25-L180-Z02	●	25	2	25	180	50	6	RPMT 1204..	4015-M4x9	-	-	80-T15
new AEMR-RP1204M-D25-C25-L180-Z02-H	●	25	2	25	180	50	6					
AEMR-RP1204M-D32-W32-L150-Z03-H	●	32	3	32	150	60	6					
AEMR-RP1204M-D32-W32-L200-Z03-H	●	32	3	32	200	100	6					
new AEMR-RP1204M-D36-C25-L160-Z03	●	36	3	25	160	30	3	RPMT 1606..	1020-M5x11	-	-	80-T20
AEMR-RP1606M-D40-W32-L150-Z02-H	●	40	2	16	150	35	8					
AEMR-RP1606M-D40-W32-L200-Z02-H	●	40	2	16	200	35	8					

R: Sağ / Right / Правый L: Sol / Left / Левый
● Stokta / In Stock / В наличии ○ Stokta Yok / Non Stock Item / Нет в наличии
MTSBH Ucuna Uygunudur. / Compatible with MTSBH Insert. / Под пластину MTSBH

Sipariş Örneği/Ordering Example/Образец заказа
1 ad./pcs./шт. AEMR-RP08T2M-D20-W20-L150-Z02-H
Kesme Hesabı : S 377 / Cutting Calculation : P 377 / Расчет режимов резания: стр. 377



➤ **S-SİSTEM YÜZEY ve KOPYA PARMAK FREZELER**
S-SYSTEM FACE and COPY END MILLS
С-ТИП КОНЦЕВЫЕ РАДИУСНЫЕ ФРЕЗЫ

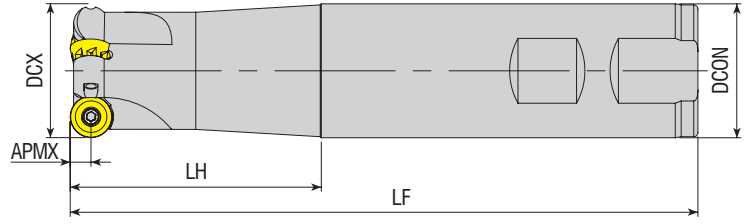

Takım Kodu Ordering Code Код для заказа	Stok Stock Наличие	Takım Ölçüleri (mm) Dimension (mm) Размеры (мм)						Kesici Uç Insert Пластина	Yedek Parçaları / Spare Parts / Запасные части			
		DCX	ZEFP	DCON	LF	LH	APMX		Sıkma Vidası Screw Зажимной винт	Baskı Parçası Wedge Clamp Прижим	Baskı Vidası Clamp Screw Зажимной винт	Tork Anahtar Torx Key Торх Ключ
AEMR-RP10T3-D25-W25-L125-Z02	●	25	2	25	125	60	5	RPNX 10T3..	4010-M3x8	-	-	82-T10
AEMR-RP10T3-D25-W25-L150-Z02	●	25	2	25	150	60	5					
AEMR-RP10T3-D32-W32-L150-Z03	●	32	3	32	150	60	5					

CRTZT Ucuna Uygunur. / Compatible with CRTZT Insert. / Под пластину CRTZT

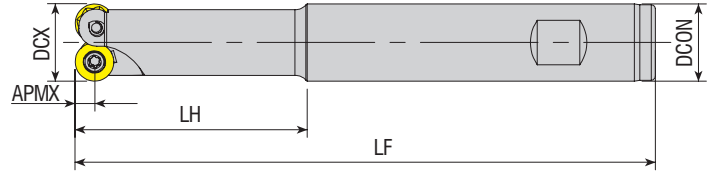

Takım Kodu Ordering Code Код для заказа	Stok Stock Наличие	Takım Ölçüleri (mm) Dimension (mm) Размеры (мм)						Kesici Uç Insert Пластина	Yedek Parçaları / Spare Parts / Запасные части		
		DCX	ZEFP	DCON	LF	LH	APMX		Sıkma Vidası Screw Зажимной винт	Tork Anahtar Torx Key Торх Ключ	
AEMR-RY08-D16-W16-L150-Z02	●	16	2	16	150	55	4	RYMX 0803..	4010-M3x6	82-T10	
AEMR-RY10-D20-W20-L150-Z02	●	20	2	20	150	60	5				
AEMR-RY10-D20-C20-L200-Z02	●	20	2	20	200	100	5	RYMX 1004..	4015-M3.5x8	80-T15	
AEMR-RY10-D21-W20-L200-Z02-H	●	21	2	20	200	30	5				
AEMR-RY10-D25-W25-L150-Z02	●	25	2	25	150	60	5				
AEMR-RY10-D26-W25-L200-Z02-H	●	26	2	25	200	60	5				
AEMR-RY10-D32-W32-L160-Z04-H	●	32	4	32	160	60	5	RYMX 1205..	4015-M4x11		
AEMR-RY12-D32-C25-L160-Z03	●	32	3	25	160	30	6				

R: Sağ / Right / Правый L: Sol / Left / Левый
 ● Stokta / In Stock / В наличии ○ Stokta Yok / Non Stock Item / Нет в наличии
 TGTC Ucuna Uygunur. / Compatible with TGTC Insert. / Под пластину TGTC.

Sipariş Örneği/Ordering Example/Образец заказа
 1 ad./pcs./шт. AEMR-RP10T3-D25-W25-L125-Z02
 Kesme Hesabı : S 377/ Cutting Calculation : P 377 / Расчет режимов резания: стр. 377

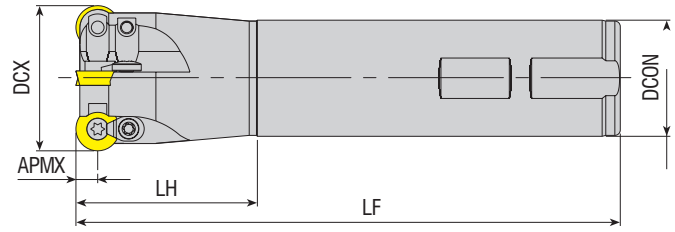

Takım Kodu Ordering Code Код для заказа	Stok Stock Наличие	Takım Ölçüleri (mm) Dimension (mm) Размеры (мм)						Kesici Uç Insert Пластина	Yedek Parçaları / Spare Parts / Запасные части					
		DCX	ZEP	DCON	LF	LH	APMX		Sıkma Vidası Screw Зажимной винт	Baskı Parçası Wedge Clamp Прижим	Baskı Vidası Clamp Screw Зажимной винт	Tork Anahtar Torx Key Торх Ключ		
AEMR-RD0501-D08-W10-L100-Z01-H	●	8	1	10	100	20	2.5	RD.. 0501	3006-M2x3.6			82-T06		
AEMR-RD0501-D10-W12-L100-Z02-H	●	10	2	12	100	20	2.5		3006-M2x4					
AEMR-RD0501-D12-W12-L120-Z02-H	●	12	2	12	120	20	2.5	RD.. 0803	3008-M3x6	-	-	82-T08		
AEMR-RD0803-D16-W16-L150-Z02	●	16	2	16	150	60	4							
AEMR-RD0803-D16-C20-L200-Z02	●	16	2	20	200	60	4	RD.. 08T2	3008-M2.5x6			82-T08		
AEMR-RD0803-D20-W20-L150-Z03	●	20	3	20	150	60	4							
AEMR-RD08T2-D16-W16-L150-Z02	●	16	2	16	150	60	4	RD.. 1003				80-T15		
AEMR-RD08T2-D20-W20-L150-Z02	●	20	2	20	150	60	4							
AEMRC-RD1003-D20-W20-L150-Z02	●	20	2	20	150	60	5							
AEMRC-RD1003-D20-C20-L160-Z02	●	20	2	20	160	70	5							
AEMRC-RD1003-D20-C20-L250-Z02	●	20	2	20	250	150	5							
AEMRC-RD1003-D21-C20-L160-Z02	●	21	2	20	160	70	5							
AEMRC-RD1003-D25-W25-L150-Z02	●	25	2	25	150	60	5							
AEMRC-RD1003-D25-C25-L160-Z02	●	25	2	25	160	70	5							
AEMRC-RD1003-D25-C25-L200-Z02	●	25	2	25	200	100	5							
AEMRC-RD1003-D25-C25-L200-Z02	●	25	2	25	200	100	5							
AEMRC-RD1003-D25-C25-L250-Z02	●	25	2	25	250	150	5							
AEMRC-RD1003-D26-C25-L160-Z02	●	26	2	25	160	70	5							
AEMRC-RD1003-D32-W32-L150-Z03	●	32	3	32	150	60	5							
AEMRC-RD1003-D32-C32-L250-Z02	●	32	2	32	250	150	5							
AEMRC-RD1003-D33-C32-L160-Z03	●	33	3	32	160	70	5							
AEMRC-RD1003-D40-W32-L150-Z04	●	40	4	32	150	35	5							
AEMRC-RD1003-D40-C32-L250-Z02	●	40	2	32	250	50	5							
new AEMR-RD10T3-D20-C20-L180-Z02-H	○	20	2	20	180	60	5				4015-M3.5x9			
AEMRC-RD10T3-D20-C20-L150-Z02	●	20	2	20	150	60	5		RD.. 10T3	4015-M3.5x9	ACK-15		4015-M3.5x11	80-T15
AEMRC-RD10T3-D20-W20-L150-Z02	●	20	2	20	150	60	5							
new AEMRC-RD10T3-D21-C20-L200-Z02-H	○	21	2	20	200	80	5							
AEMRC-RD10T3-D25-C25-L150-Z02	●	25	2	25	150	60	5							
AEMRC-RD10T3-D25-C25-L200-Z02-H	●	25	2	25	200	100	5							
new AEMRC-RD10T3-D25-C32-L150-Z03	●	25	3	32	150	50	5							
AEMRC-RD10T3-D25-W25-L150-Z02	●	25	2	25	150	60	5							
new AEMRC-RD10T3-D26-C25-L200-Z02-H	○	26	2	25	200	35	5							
AEMRC-RD10T3-D32-C25-L250-Z03-H	●	32	3	25	250	35	5							
AEMRC-RD10T3-D32-W32-L150-Z03	●	32	3	32	150	60	5							
new AEMRC-RD10T3-D32-C32-L150-Z04	●	32	4	32	150	60	5							
AEMRC-RD12T3-D25-W25-L150-Z02	●	25	2	25	150	60	6	RD.. 12T3					80-T15	
AEMRC-RD12T3-D25-W25-L200-Z02	●	25	2	25	200	100	6							
AEMRC-RD12T3-D25-C25-L250-Z02	●	25	2	25	250	150	6							
AEMRC-RD12T3-D25-C25-L300-Z02	●	25	2	25	300	200	6							
AEMRC-RD12T3-D32-W32-L150-Z03	●	32	3	32	150	60	6							
AEMRC-RD12T3-D32-C32-L250-Z02	●	32	2	32	250	150	6							
AEMRC-RD12T3-D40-W32-L150-Z04	●	40	4	32	150	50	6							
AEMRC-RD12T3-D40-C32-L250-Z02	●	40	2	32	250	50	6							
new AEMRC-RD1204-D32-C32-L200-Z02	●	32	2	32	200	100	6	RD.. 1204					80-T15	
AEMRC-RD1204-D32-C32-L160-Z03	●	32	3	32	160	70	6							
AEMRC-RD1204-D32-W32-L160-Z03	●	32	3	32	160	70	6							
AEMRC-RD1204-D33-C32-L160-Z03	●	33	3	32	160	70	6							
new AEMRC-RD1204-D32-C32-L160-Z03-H	●	32	3	32	160	70	6	RD.. 1604	4015-M4.5x11	ACK-05	4015-M4x11	80-T15		
AEMRC-RD1604-D40-W32-L150-Z02	●	40	2	32	150	35	8							

R: Sağ / Right / Правый L: Sol / Left / Левый

● Stokta / In Stock / В наличии ○ Stokta Yok / Non Stock Item / Нет в наличии
ISO Uçuna Uygundur. / Compatible with ISO Insert. / Под пластину ISO.

Sipariş Örneği/Ordering Example/Образец заказа

1 ad./pcs./шт. AEMR-RD0501-D08-W10-L100-Z01-H

Kesme Hesabı : S 377/ Cutting Calculation : P 377 / Расчет режимов резания: стр. 377

S-SİSTEM YÜZEY ve KOPYA PARMAK FREZELER
S-SYSTEM FACE and COPY END MILLS
S-ТИП КОНЦЕВЫЕ РАДИУСНЫЕ ФРЕЗЫ

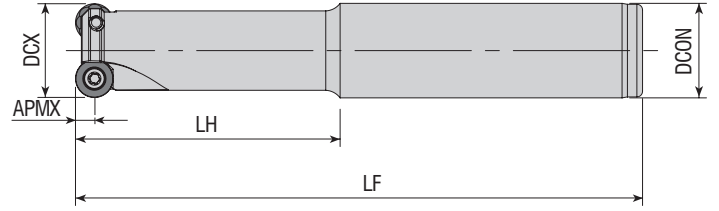

Takım Kodu Ordering Code Код для заказа	Stok Stock Наличие	Takım Ölçüleri (mm) Dimension (mm) Размеры (мм)						Kesici Uç Insert Пластина	Yedek Parçaları / Spare Parts / Запасные части			
		DCX	ZEFP	DCON	LF	LH	APMX		Sıkma Vidası Screw Зажимной винт	Baskı Parçası Wedge Clamp Прижим	Baskı Vidası Clamp Screw Зажимной винт	Tork Anahtar Torx Key Торх Ключ
AEMR-QP10T3-D20-C20-L150-Z01-H	●	20	1	20	150	70	5	QP. 10T3..	4015-M3.5x9	-	-	80-T15
AEMR-QP10T3-D25-C25-L120-Z02-H	●	25	2	25	120	40	5					
AEMR-QP10T3-D25-C25-L150-Z02-H	●	25	2	25	150	70	5					
AEMR-QP10T3-D25-C25-L170-Z02	●	25	2	25	170	90	5					
AEMR-QP10T3-D32-C32-L150-Z03-H	●	32	3	32	150	70	5					
AEMR-QP10T3-D32-C32-L170-Z03	●	32	3	32	170	90	5					
AEMR-QP1204-D25-C25-L150-Z02-H	●	25	2	25	150	70	6	QP. 1204..	4015-M4x9	-	-	

SMTM Ucuna Uygundur. / Compatible with SMTM Insert. / Под пластину SMTM.

S-SİSTEM HIZLI İLERLEMELİ PARMAK FREZELER
S-SYSTEM HIGHFEED END MILLS
S-ТИП ВЫСОКОПРОИЗВОДИТЕЛЬНЫЕ КОНЦЕВЫЕ ФРЕЗЫ

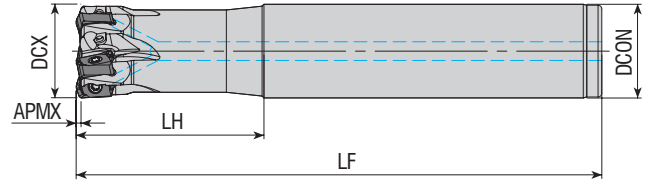

Takım Kodu Ordering Code Код для заказа	Stok Stock Наличие	Takım Ölçüleri (mm) Dimension (mm) Размеры (мм)						Kesici Uç Insert Пластина	Yedek Parçaları / Spare Parts / Запасные части	
		DCX	ZEFP	DCON	LF	LH	APMX		Sıkma Vidası Screw Зажимной винт	Tork Anahtar Torx Key Торх Ключ
AHFM-BN10T3-D16-C16-L100-Z02-H	●	16	2	16	100	30	1	BNGX 10T3..	3008-M2.5x6	82-T08
AHFM-BN10T3-D16-C16-L150-Z02-H	●	16	2	16	150	50	1			
AHFM-BN10T3-D20-C20-L130-Z03-H	●	20	3	20	130	40	1			
AHFM-BN10T3-D20-C20-L130-Z04-H	●	20	4	20	130	40	1			
AHFM-BN10T3-D20-C20-L160-Z03-H	●	20	3	20	160	80	1			
AHFM-BN10T3-D25-C25-L140-Z04-H	●	25	4	25	140	50	1			
AHFM-BN10T3-D25-W25-L140-Z04-H	●	25	4	25	140	50	1			
AHFM-BN10T3-D25-C25-L140-Z05-H	●	25	5	25	140	50	1			
AHFM-BN10T3-D25-C25-L180-Z04-H	●	25	4	25	180	100	1			
AHFM-BN10T3-D32-C32-L150-Z05-H	●	32	5	32	150	70	1			
AHFM-BN10T3-D32-C32-L150-Z06-H	●	32	6	32	150	70	1			
AHFM-BN10T3-D35-C32-L200-Z06-H	●	35	6	32	200	50	1			

R: Sağ / Right / Правый L: Sol / Left / Левый

● Stokta / In Stock / В наличии ○ Stokta Yok / Non Stock Item / Нет в наличии

PRMT Ucuna Uygundur. / Compatible with PRMT Insert. / Под пластину PRMT.

Sipariş Örneği/Ordering Example/Образец заказа

1 ad./pcs./шт. AEMR-QP10T3-D20-C20-L150-Z01-H

Kesme Hesabı : S 377 / Cutting Calculation : P 377 / Расчет режимов резания: стр. 377



www.akkо.com.tr

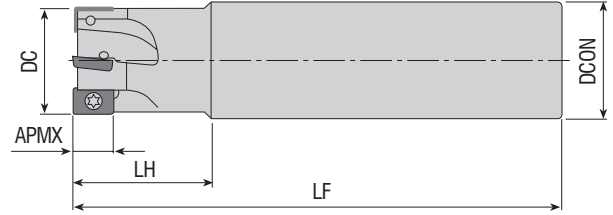

Takım Kodu Ordering Code Код для заказа	Stok Stock Наличие	Takım Ölçüleri (mm) Dimension (mm) Размеры (мм)						Kesici Uç Insert Пластина	Yedek Parçaları / Spare Parts / Запасные части		
		DC	ZEFP	DCON	LF	LH	APMX		Sıkma Vidası Screw Зажимной винт	Tork Anahtar Torx Key Торх Ключ	
AHFM-E00602-D10-C10-L080-Z02	●	10	2	10	80	20	-	EO.. 0602.. ZOMT 0602..	3006-M1.8x4	82-T06	
AHFM-E00602-D10-C09-L120-Z02	●	10	2	9	120	15	-				
AHFM-E00602-D10-C10-L120-Z02	●	10	2	10	120	60	-				
AHFM-E00602-D12-C12-L080-Z02	●	12	2	12	80	20	-				
AHFM-E00602-D12-C12-L080-Z03	●	12	3	12	80	20	-				
AHFM-E00602-D12-C11-L120-Z02	●	12	2	11	120	15	-				
AHFM-E00602-D12-C11-L120-Z03	●	12	3	11	120	15	-				
AHFM-E00602-D12-C12-L120-Z02	●	12	2	12	120	60	-				
AHFM-E00602-D12-C12-L120-Z03	●	12	3	12	120	60	-				
AHFM-E00602-D16-C16-L150-Z04	●	16	4	16	150	60	-				

DJT Ucuna Uygundur. / Compatible with DJT Insert. / Под пластину DJT

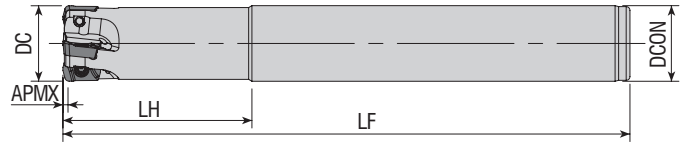

Takım Kodu Ordering Code Код для заказа	Stok Stock Наличие	Takım Ölçüleri (mm) Dimension (mm) Размеры (мм)						Kesici Uç Insert Пластина	Yedek Parçaları / Spare Parts / Запасные части		
		DC	ZEFP	DCON	LF	LH	APMX		Sıkma Vidası Screw Зажимной винт	Tork Anahtar Torx Key Торх Ключ	
new AHFM-EP1003-D16-C16-L80-Z02-H	●	16	2	16	80	20	1	EP. 1003.. ZPMT 1003.. YPHW 1003..	3008-M2.5x5	82-T08	
AHFM-EP1003-D16-C16-L150-Z02-H	●	16	2	16	150	50	1				
AHFM-EP1003-D17-C16-L150-Z02-H	●	17	2	16	150	20	1				
AHFM-EP1003-D20-C20-L150-Z04-H	●	20	4	20	150	50	1				
AHFM-EP1003-D21-C20-L150-Z04-H	●	21	4	20	150	20	1				
AHFM-EP1003-D25-C25-L200-Z04-H	●	25	4	25	200	100	1				
AHFM-EP1003-D25-C25-L250-Z04-H	●	25	4	25	250	100	1				

R: Sağ / Right / Правый L: Sol / Left / Левый

● Stokta / In Stock / В наличии ○ Stokta Yok / Non Stock Item / Нет в наличии

DJT Ucuna Uygundur. / Compatible with DJT Insert. / Под пластину DJT

Sipariş Örneği/Ordering Example/Образец заказа

1 ad./pcs./шт. AHFM-E00602-D10-C10-L080-Z02

Kesme Hesabı : S 377 / Cutting Calculation : P 377 / Расчет режимов резания: стр. 377

S-SİSTEM HIZLI İLERLEMELİ PARMAK FREZELER

S-SYSTEM HIGHFEED END MILLS

S-ТИП ВЫСОКОПРОИЗВОДИТЕЛЬНЫЕ КОНЦЕВЫЕ ФРЕЗЫ

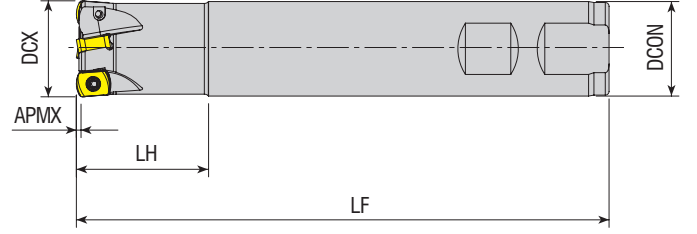

Takım Kodu Ordering Code Код для заказа	Stok Stock Наличие	Takım Ölçüleri (mm) Dimension (mm) Размеры (мм)						Kesici Uç Insert Пластина	Yedek Parçaları / Spare Parts / Запасные части		
		DCX	ZEFP	DCON	LF	LH	APMX		Sıkma Vidası Screw Зажимной винт	Tork Anahtar Torx Key Торх Ключ	
AHFM-BL0603-D16-C15-L150-Z02	●	16	2	15	150	20	1	BLMP 0603..	3008-M2.5x6	82-T08	
AHFM-BL0603-D16-C16-L100-Z02-H	●	16	2	16	100	30	1				
AHFM-BL0603-D16-C16-L150-Z02	●	16	2	16	150	50	1				
AHFM-BL0603-D17-C16-L150-Z02	●	17	2	16	150	20	1				
AHFM-BL0603-D17-W16-L170-Z02	●	17	2	16	170	20	1				
AHFM-BL0603-D17-W16-L170-Z02-H	●	17	2	16	170	20	1				
AHFM-BL0603-D17-C16-L200-Z02	●	17	2	16	200	30	1				
AHFM-BL0603-D18-C16-L150-Z02	●	18	2	16	150	20	1				
AHFM-BL0603-D18-W16-L150-Z02-H	●	18	2	16	150	20	1				
AHFM-BL0603-D20-C20-L130-Z03	●	20	3	20	130	50	1				
AHFM-BL0603-D20-C20-L160-Z03	●	20	3	20	160	50	1				
AHFM-BL0603-D21-C20-L200-Z03	●	21	3	20	200	25	1				
AHFM-BL0603-D21-W20-L200-Z03	●	21	3	20	200	25	1				
AHFM-BL0603-D22-W20-L150-Z03	●	22	3	20	150	20	1				
AHFM-BL0603-D25-C25-L250-Z04	●	25	4	25	250	40	1				
new AHFM-BL0603-D26-C25-L150-Z04	●	26	4	25	150	35	1				
AHFM-BL0603-D26-C25-L200-Z04	●	26	4	25	200	35	1				
AHFM-BL0603-D26-W25-L200-Z04	●	26	4	25	200	35	1				
AHFM-BL0603-D26-C25-L250-Z04	●	26	4	25	250	35	1				
AHFM-BL0603-D32-C32-L150-Z05	●	32	5	32	150	70	1				
AHFM-BL0603-D32-C32-L200-Z05	●	32	5	32	200	120	1				
AHFM-BL0603-D33-C32-L150-Z05	●	33	5	32	150	40	1				
AHFM-BL0603-D33-C32-L200-Z05	●	33	5	32	200	40	1				
AHFM-BL0603-D33-C32-L250-Z05	●	33	5	32	250	40	1				
new AHFM-BL0904-D28-W25-L180-Z03	●	28	3	25	180	30	1.5	BLMP 0904..	3010-M3.5x9	82-T10	

R: Sağ / Right / Правый L: Sol / Left / Левый
 ● Stokta / In Stock / В наличии ○ Stokta Yok / Non Stock Item / Нет в наличии
 TGTC Ucuna Uygunudur. / Compatible with TGTC Insert. / Под пластину TGTC.

Sipariş Örneği/Ordering Example/Образец заказа
 1 ad./pcs./шт. AHFM-BL0603-D16-C15-L150-Z02
 Kesme Hesabı : S 377/ Cutting Calculation : P 377 / Расчет режимов резания: стр. 377

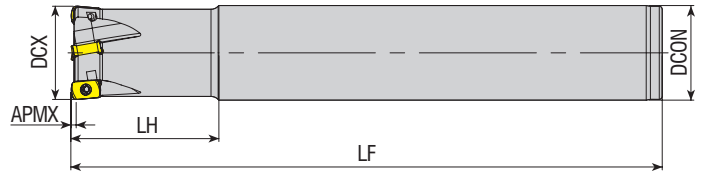

Takım Kodu Ordering Code Код для заказа	Stok Stock Наличие	Takım Ölçüleri (mm) Dimension (mm) Размеры (мм)						Kesici Uç Insert Пластина	Yedek Parçaları / Spare Parts / Запасные части		
		DCX	ZEFP	DCON	LF	LH	APMX		Sıkma Vidası Screw Зажимной винт	Tork Anahtar Torx Key Торх Ключ	
AHFM-EN1004-D16-C15-L150-Z02	●	16	2	15	150	25	1	ENMU 1004..	3008-M2.5x6	82-T08	
AHFM-EN1004-D16-C16-L150-Z02	●	16	2	16	150	25	1				
AHFM-EN1004-D16-C16-L250-Z02	●	16	2	16	250	70	1				
AHFM-EN1004-D17-C16-L150-Z02-H	●	17	2	16	150	25	1				
AHFM-EN1004-D17-C16-L150-Z02	●	17	2	16	150	25	1				
AHFM-EN1004-D17-C16-L200-Z02	●	17	2	16	200	25	1				
AHFM-EN1004-D18-C16-L150-Z02	●	18	2	16	150	25	1				
AHFM-EN1004-D20-C20-L150-Z03	●	20	3	20	150	40	1				
AHFM-EN1004-D20-C20-L250-Z03	●	20	3	20	250	70	1				
AHFM-EN1004-D21-C20-L150-Z02	●	21	2	20	150	30	1				
AHFM-EN1004-D21-C20-L150-Z03	●	21	3	20	150	30	1				
AHFM-EN1004-D21-C20-L150-Z03-H	●	21	3	20	150	30	1				
AHFM-EN1004-D21-C20-L200-Z03	●	21	3	20	200	30	1				
AHFM-EN1004-D22-C20-L150-Z03	●	22	3	20	150	30	1				
AHFM-EN1004-D25-C25-L150-Z03	●	25	3	25	150	40	1				
AHFM-EN1004-D25-C25-L150-Z04	●	25	4	25	150	40	1				
AHFM-EN1004-D26-C25-L150-Z03	●	26	3	25	150	30	1				
AHFM-EN1004-D26-C25-L150-Z04	●	26	4	25	150	30	1				
AHFM-EN1004-D26-C25-L200-Z03	●	26	3	25	200	30	1				
AHFM-EN1004-D26-C25-L200-Z03-H	●	26	3	25	200	30	1				
AHFM-EN1004-D26-C25-L250-Z03-H	●	26	3	25	250	30	1				
AHFM-EN1004-D28-C25-L200-Z04	●	28	4	25	200	30	1				
AHFM-EN1004-D32-C32-L200-Z04	●	32	4	32	200	50	1				
AHFM-EN1004-D33-C32-L200-Z04	●	33	4	32	200	30	1				
AHFM-EN1004-D33-C32-L200-Z04-H	●	33	4	32	200	30	1				

R: Sağ / Right / Правый L: Sol / Left / Левый

● Stokta / In Stock / В наличии ○ Stokta Yok / Non Stock Item / Нет в наличии

DJT Ucuna Uygun. / Compatible with DJT Insert. / Под пластину DJT

Sipariş Örneği/Ordering Example/Образец заказа

1 ad./pcs./шт. AHFM-EN1004-D16-C15-L150-Z02

Kesme Hesabı : S 377/ Cutting Calculation : P 377 / Расчет режимов резания: стр. 377



S-SİSTEM HIZLI İLERLEMELİ PARMAK FREZELER
S-SYSTEM HIGHFEED END MILLS
S-ТИП ВЫСОКОПРОИЗВОДИТЕЛЬНЫЕ КОНЦЕВЫЕ ФРЕЗЫ

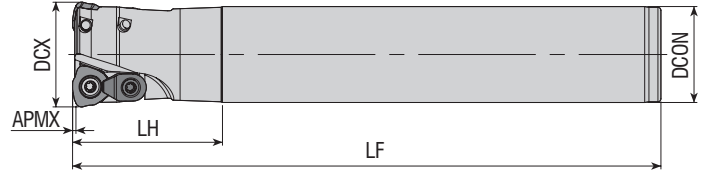

Takım Kodu Ordering Code Код для заказа	Stok Stock Наличие	Takım Ölçüleri (mm) Dimension (mm) Размеры (мм)						Kesici Uç Insert Пластина	Yedek Parçaları / Spare Parts / Запасные части			
		DCX	ZEFP	DCON	LF	LH	APMX		Sıkma Vidası Screw Зажимной винт	Baskı Parçası Wedge Clamp Прижим	Baskı Vidası Clamp Screw Зажимной винт	Tork Anahtar Torx Key Торх Ключ
AHFMC-JD1204-D32-C32-L150-Z02	●	32	2	32	150	50	1	JDMW 1204..	4615-M4x11	ACK-05	4015-M4x11	80-T15
AHFMC-JD1204-D32-C32-L200-Z02	●	32	2	32	200	50	1					
AHFMC-JD1204-D35-C32-L200-Z02	●	35	2	32	200	50	1					
AHFMC-JD1204-D35-C32-L250-Z02	●	35	2	32	250	50	1					

MTSBH Ucuna Uygundur. / Compatible with MTSBHInsert. / Под пластину MTSBH.

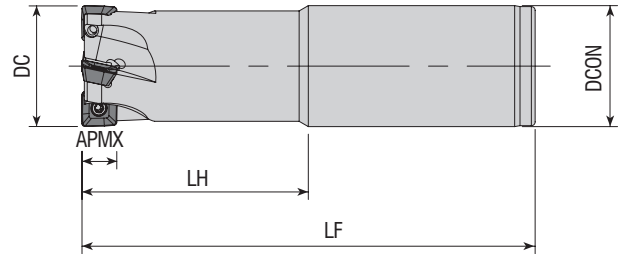

Takım Kodu Ordering Code Код для заказа	Stok Stock Наличие	Takım Ölçüleri (mm) Dimension (mm) Размеры (мм)						Kesici Uç Insert Пластина	Yedek Parçaları / Spare Parts / Запасные части	
		DCX	ZEFP	DCON	LF	LH	APMX		Sıkma Vidası Screw Зажимной винт	Tork Anahtar Torx Key Торх Ключ
AHFM-SP0735-D16-C16-L160-Z02-H	●	16	2	16	160	30	1.2	SPMX 073505	3108-M3x6	82-T08
AHFM-SP0735-D17-C16-L160-Z02-H	●	17	2	16	160	30	1.2			
AHFM-SP0735-D20-C20-L160-Z03-H	●	20	2	20	160	30	1.2			
AHFM-SP0735-D21-C20-L160-Z03-H	●	21	2	20	160	30	1.2			

R: Sağ / Right / Правый L: Sol / Left / Левый
 ● Stokta / In Stock / В наличии ○ Stokta Yok / Non Stock Item / Нет в наличии
 MTSBH Ucuna Uygundur. / Compatible with MTSBH Insert. / Под пластину MTSBH.

Sipariş Örneği/Ordering Example/Образец заказа
 1 ad./pcs./шт. AHFMC-JD1204-D32-C32-L150-Z02
 Kesme Hesabı : S 377 / Cutting Calculation : P 377 / Расчет режимов резания: стр. 377

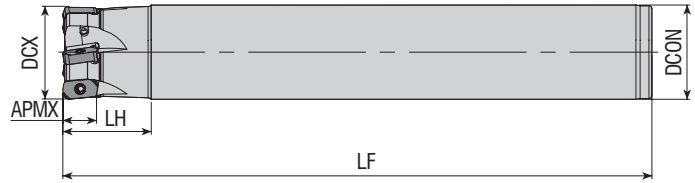

Takım Kodu Ordering Code Код для заказа	Stok Stock Наличие	Takım Ölçüleri (mm) Dimension (mm) Размеры (мм)						Kesici Uç Insert Пластина	Yedek Parçaları / Spare Parts / Запасные части		
		DCX	ZEFP	DCON	LF	LH	APMX		Sıkma Vidası Screw Зажимной винт	Tork Anahtar Torx Key Торх Ключ	
AHFM-LN0303-D16-C15-L150-Z02	●	16	2	15	150	30	12	LNMU 0303..	3008-M2.5x6	82-T08	
AHFM-LN0303-D16-W16-L150-Z02-H	●	16	2	16	150	50	12				
new AHFM-LN0303-D17-C16-L150-Z02-H	●	17	2	16	150	30	12				
AHFM-LN0303-D20-W20-L150-Z03-H	●	20	3	20	150	50	12				
AHFM-LN0303-D21-C20-L150-Z03	●	21	3	20	150	30	12				
AHFM-LN0303-D25-W25-L150-Z04-H	●	25	4	25	150	50	12				
AHFM-LN0303-D26-C25-L150-Z04	●	26	4	25	150	30	12				
new AHFM-LN0303-D28-C25-L180-Z03	●	28	3	25	180	30	12				
AHFM-LN0303-D33-C32-L200-Z05	●	33	5	32	200	30	12				

TNGLY Uçuna Uygundur. / Compatible with TNGLY Insert. / Под пластину TNGLY.

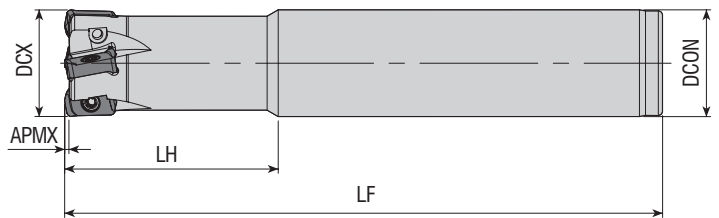

Takım Kodu Ordering Code Код для заказа	Stok Stock Наличие	Takım Ölçüleri (mm) Dimension (mm) Размеры (мм)						Kesici Uç Insert Пластина	Yedek Parçaları / Spare Parts / Запасные части		
		DCX	ZEFP	DCON	LF	LH	APMX		Sıkma Vidası Screw Зажимной винт	Tork Anahtar Torx Key Торх Ключ	
AHFM-L003-D16-C15-L160-Z02	●	16	2	15	160	30	1	LOGU 0303..	1108-M3x6.8	82-T08	
AHFM-L003-D16-C16-L100-Z02-F	●	16	2	16	100	30	1				
AHFM-L003-D16-C16-L100-Z02	●	16	2	16	100	30	1				
AHFM-L003-D16-C16-L130-Z02-H	●	16	2	16	130	40	1				
AHFM-L003-D16-C16-L160-Z02	●	16	2	16	160	50	1				
AHFM-L003-D16-C16-L160-Z02-H	●	16	2	16	160	100	1				
AHFM-L003-D17-C16-L180-Z02	●	17	2	16	180	30	1				
AHFM-L003-D20-C20-L130-Z03	●	20	3	20	130	40	1				
AHFM-L003-D20-C20-L130-Z03-H	●	20	3	20	130	40	1				
AHFM-L003-D20-C20-L160-Z03	●	20	3	20	160	80	1				
AHFM-L003-D20-C20-L160-Z03-H	●	20	3	20	160	100	1				
AHFM-L003-D21-C20-L150-Z03-H	●	21	3	20	150	30	1				
AHFM-L003-D21-C20-L200-Z03	●	21	3	20	200	30	1				
AHFM-L003-D21-C20-L200-Z03-H	●	21	3	20	200	30	1				
AHFM-L003-D25-C25-L140-Z04-F	●	25	4	25	140	50	1				
AHFM-L003-D25-C25-L140-Z04	●	25	4	25	140	50	1				
AHFM-L003-D25-C25-L180-Z04	●	25	4	25	180	100	1				
AHFM-L003-D26-C25-L250-Z04	●	26	4	25	250	40	1				
AHFM-L003-D32-C32-L200-Z05	●	32	5	32	200	120	1				
AHFM-L003-D33-C32-L250-Z05	●	33	5	32	250	40	1				

R: Sağ / Right / Правый L: Sol / Left / Левый

● Stokta / In Stock / В наличии ○ Stokta Yok / Non Stock Item / Нет в наличии

KYCR Uçuna Uygundur. / Compatible with KYCR Insert. / Под пластину KYCR

F: Eksenel ve Radyal Salgı Değeri 0,02 mm içindedir. / F: Axial and Radial Runout Value is within 0,02 mm.

F: значение радиального и осевого биения в пределах 0,02 мм.

Sipariş Örneği/Ordering Example/Образец заказа
1 ad./pcs./шт. AHFM-LN0303-D16-C15-L150-Z02
Kesme Hesabı : S 377/ Cutting Calculation : P 377 / Расчет режимов резания: стр. 377

S-SİSTEM HIZLI İLERLEMELİ PARMAK FREZELER
S-SYSTEM HIGHFEED END MILLS
S-ТИП ВЫСОКОПРОИЗВОДИТЕЛЬНЫЕ КОНЦЕВЫЕ ФРЕЗЫ

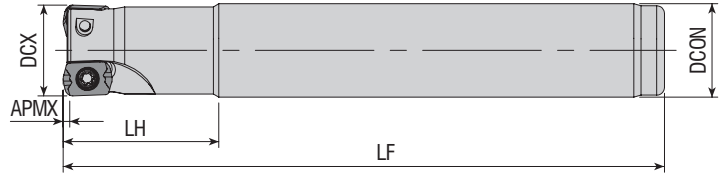

Takım Kodu Ordering Code Код для заказа	Stok Stock Наличие	Takım Ölçüleri (mm) Dimension (mm) Размеры (мм)						Kesici Uç Insert Пластина	Yedek Parçaları / Spare Parts / Запасные части		
		DCX	ZEFP	DCON	LF	LH	APMX		Sıkma Vidası Screw Зажимной винт	Tork Anahtar Torx Key Торх Ключ	
AHFM-LP0102-D10-C09-L120-Z02	●	10	2	9	120	20	0.5	LPGT 0102..		3006-M1.8x4	
AHFM-LP0102-D10-C10-L120-Z02	●	10	2	10	120	20	0.5				
AHFM-LP0102-D12-C11-L120-Z02	●	12	2	11	120	20	0.5				
AHFM-LP0102-D12-C12-L120-Z02	●	12	2	12	120	20	0.5				

KYCR Ucuna Uygundur. / Compatible with KYCR Insert. / Под пластину KYCR

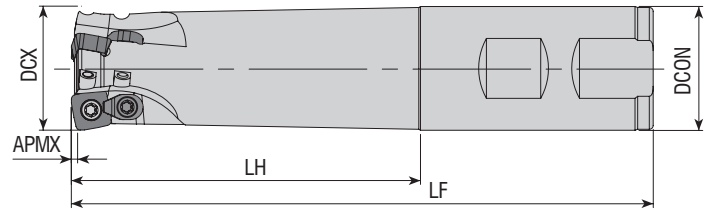

Takım Kodu Ordering Code Код для заказа	Stok Stock Наличие	Takım Ölçüleri (mm) Dimension (mm) Размеры (мм)						Kesici Uç Insert Пластина	Yedek Parçaları / Spare Parts / Запасные части			
		DCX	ZEFP	DCON	LF	LH	APMX		Sıkma Vidası Screw Зажимной винт	Baskı Parçası Wedge Clamp Прижим	Baskı Vidası Clamp Screw Зажимной винт	Tork Anahtar Torx Key Торх Ключ
AHFM-SD06T2-D16-C16-L100-Z02-H	●	16	2	16	100	50	0.8	SD.. 06T2..				82-T07
AHFM-SD06T2-D16-C16-L150-Z02-H	●	16	2	16	150	50	0.8					
AHFM-SD06T2-D16-C16-L200-Z02	●	16	2	16	200	100	0.8					
AHFM-SD06T2-D17-C16-L150-Z02-H	●	17	2	16	150	50	0.8					
AHFM-SD06T2-D20-C20-L150-Z03-H	●	20	3	20	150	50	0.8					
AHFM-SD06T2-D20-C20-L200-Z03	●	20	3	20	200	100	0.8					
AHFM-SD06T2-D21-C20-L150-Z03-H	●	21	3	20	150	50	0.8					
AHFM-SD06T2-D25-C25-L150-Z04-H	●	25	4	25	150	60	0.8					
AHFM-SD06T2-D26-C25-L150-Z04-H	●	26	4	25	150	60	0.8					
AHFMC-SD09T3-D22-W20-L150-Z02	●	22	2	20	150	30	1.4					
AHFMC-SD09T3-D25-C25-L150-Z02	●	25	2	25	150	94	1.4					
AHFMC-SD09T3-D25-W25-L150-Z02	●	25	2	25	150	94	1.4					
AHFMC-SD09T3-D28-C25-L150-Z02	●	28	2	25	150	30	1.4					
AHFMC-SD09T3-D32-C32-L150-Z03	●	32	3	32	150	100	1.4					
AHFMC-SD09T3-D32-W32-L150-Z03	●	32	3	32	150	90	1.4					
AHFMC-SD09T3-D25-C25-L150-Z03	●	25	3	25	150	60	1.4					
AHFMC-SD09T3-D32-C32-L150-Z04	●	32	4	25	150	60	1.4					



R: Sağ / Right / Правый L: Sol / Left / Левый
 ● Stokta / In Stock / В наличии ○ Stokta Yok / Non Stock Item / Нет в наличии
 ZCC Ucuna Uygundur. / Compatible with ZCC Insert. / Под пластину ZCC

Sipariş Örneği/Ordering Example/Образец заказа

1 ad./pcs./шт. AHFM-LP0102-D10-C09-L120-Z02

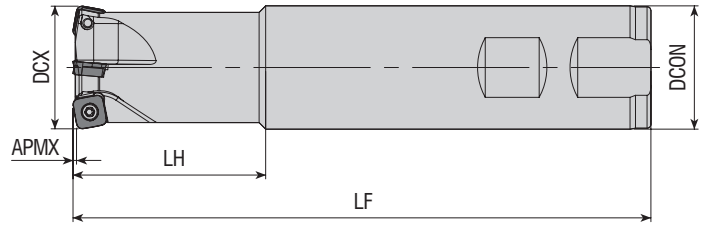

Kesme Hesabı : S 377/ Cutting Calculation : P 377 / Расчет режимов резания: стр. 377

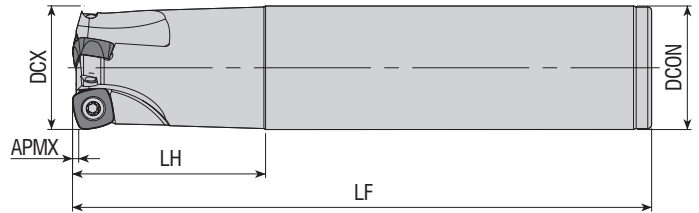

Takım Kodu Ordering Code Код для заказа	Stok Stock Наличие	Takım Ölçüleri (mm) Dimension (mm) Размеры (мм)						Kesici Uç Insert Пластина	Yedek Parçaları / Spare Parts / Запасные части				
		DCX	ZEFP	DCON	LF	LH	APMX		Sıkma Vidası Screw Зажимной винт	Tork Anahtar Torx Key Торх Ключ			
AHFM-S00803-D20-W20-L150-Z02	●	20	2	20	150	50	-						
AHFM-S00803-D25-W25-L150-Z03	●	25	3	25	150	50	-				SOMW 0803..	4010-M3x8	82-T10
AHFM-S00803-D32-W32-L150-Z04	●	32	4	32	150	50	-						

KPTK Ucuna Uygunudur. / Compatible with KPTK Insert. / Под пластину KPTK



Takım Kodu Ordering Code Код для заказа	Stok Stock Наличие	Takım Ölçüleri (mm) Dimension (mm) Размеры (мм)						Kesici Uç Insert Пластина	Yedek Parçaları / Spare Parts / Запасные части		
		DCX	ZEFP	DCON	LF	LH	APMX		Sıkma Vidası Screw Зажимной винт	Tork Anahtar Torx Key Торх Ключ	
AHFM-SP1004-D25-C25-L150-Z02	●	25	2	25	150	50	1.5				
AHFM-SP1004-D32-C32-L150-Z03	●	32	3	32	150	50	1.5				SPNW 1004..

R: Sağ / Right / Правый L: Sol / Left / Левый

● Stokta / In Stock / В наличии ○ Stokta Yok / Non Stock Item / Нет в наличии
DJT Ucuna Uygunudur. / Compatible with DJT Insert. / Под пластину DJT



Sipariş Örneği/Ordering Example/Образец заказа

1 ad./pcs./шт. AHFM-S00803-D20-W20-L150-Z02

Kesme Hesabı : S 377/ Cutting Calculation : P 377 / Расчет режимов резания: стр. 377

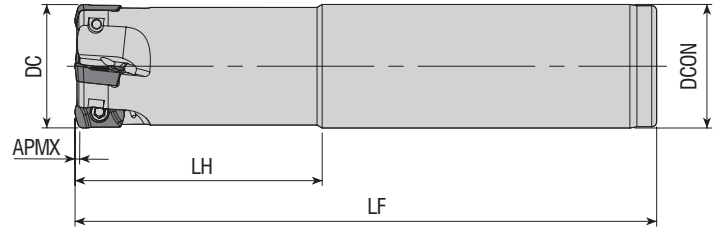
S-SİSTEM HIZLI İLERLEMELİ PARMAK FREZELER
S-SYSTEM HIGHFEED END MILLS
S-ТИП ВЫСОКОПРОИЗВОДИТЕЛЬНЫЕ КОНЦЕВЫЕ ФРЕЗЫ



Takım Kodu Ordering Code Код для заказа	Stok Stock Наличие	Takım Ölçüleri (mm) Dimension (mm) Размеры (мм)						Kesici Uç Insert Пластина	Yedek Parçaları / Spare Parts / Запасные части		
		DC	ZEFP	DCON	LF	LH	APMX		Sıkma Vidası Screw Зажимной винт	Tork Anahtar Torx Key Торх Ключ	
AHFM-YP1003-D16-C15-L150-Z02-F	●	16	2	15	150	20	1	 EP. 1003.. YPHW 1003.. ZPMT 1003..	 3008-M2.5x5	 82-T08	
AHFM-YP1003-D16-C15-L200-Z02-F	●	16	2	15	200	20	1				
AHFM-YP1003-D16-C16-L150-Z02-F	●	16	2	16	150	50	1				
AHFM-YP1003-D17-C16-L150-Z02-F	●	17	2	16	150	20	1				
AHFM-YP1003-D17-C16-L200-Z02-F	●	17	2	16	200	20	1				
AHFM-YP1003-D20-C18-L150-Z03-F	●	20	3	18	150	25	1				
AHFM-YP1003-D20-C18-L200-Z03-F	●	20	3	18	200	25	1				
AHFM-YP1003-D20-C20-L150-Z03-F	●	20	3	20	150	50	1				
AHFM-YP1003-D21-C20-L150-Z03-F	●	21	3	20	150	20	1				
AHFM-YP1003-D21-C20-L150-Z03-H	●	21	3	20	150	20	1				
AHFM-YP1003-D21-C20-L150-Z04-F	●	21	4	20	150	20	1				
AHFM-YP1003-D21-C20-L200-Z03	●	21	3	20	200	20	1				
AHFM-YP1003-D21-C20-L200-Z03-F	●	21	3	20	200	20	1				
AHFM-YP1003-D25-C20-L150-Z04-F	●	25	4	20	150	25	1				
AHFM-YP1003-D25-C20-L200-Z04-F	●	25	4	20	200	25	1				
AHFM-YP1003-D25-C25-L150-Z04-F	●	25	4	25	150	50	1				
AHFM-YP1003-D26-C25-L150-Z04	●	26	4	25	150	30	1				
new AHFM-YP1003-D25-C25-L150-Z04-H	●	25	4	25	150	50	1				
AHFM-YP1003-D26-C25-L150-Z04-F	●	26	4	25	150	30	1				
new AHFM-YP1003-D26-C25-L250-Z04-F	●	26	4	25	250	30	1				
AHFM-YP1003-D26-C25-L200-Z03-F	●	26	3	25	200	30	1				
AHFM-YP1003-D26-C25-L200-Z04-F	●	26	4	25	200	30	1				
new AHFM-YP1003-D33-C32-L200-Z04-F	●	33	4	32	200	30	1				
new AHFM-YP1003-D33-C32-L250-Z04-F	●	33	4	32	250	30	1				
new AHFM-YP1003-D33-C32-L300-Z04-F	●	33	4	32	300	30	1				

R: Sağ / Right / Правый L: Sol / Left / Левый

● Stokta / In Stock / В наличии ○ Stokta Yok / Non Stock Item / Нет в наличии

DJT Ucuna Uygunudur. / Compatible with DJT Insert. / Под пластину DJT

Çap Ölçüsü - 0,02 mm Olarak üretiliyor. F: ± 0,02 mm Demektir. Ör: Ø16 Takım 15,98 ± 0,02 mm yani 16,00 mm - 15,96 mm Olmalıdır.

Diameter Size is produced as - 0,02 mm. F: means ± 0,02 mm. For example: Ø16 tool 15,98 ± 0,02 mm, it means that it should be 16,00 mm - 15,96 mm.

Размер диаметра составляет -0,02 мм. F: означает ± 0,02 мм. Например: Ø16 инструмент 15,98 ± 0,02 мм, должно быть 16,00 мм - 15,96 мм.

Sipariş Örneği/Ordering Example/Образец заказа

1 ad./pcs./шт. AHFM-YP1003-D16-C15-L150-Z02-F

Kesme Hesabı : S 377/ Cutting Calculation : P 377 / Расчет режимов резания: стр. 377



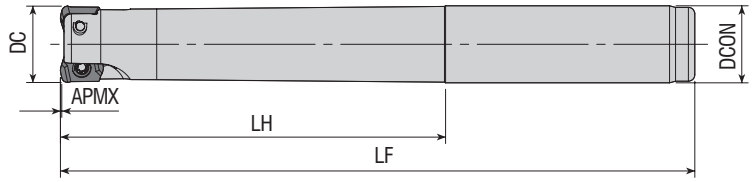

Takım Kodu Ordering Code Код для заказа	Stok Stock Наличие	Takım Ölçüleri (mm) Dimension (mm) Размеры (мм)						Kesici Uç Insert Пластина	Yedek Parçaları / Spare Parts / Запасные части		
		DC	ZEFP	DCON	LF	LH	APMX		Sıkma Vidası Screw Зажимной винт	Baskı Parçası Wedge Clamp Прижим	Tork Anahtar Torx Key Торх Ключ
AHFM-YO0602-D10-C09-L120-Z02-F	●	10	2	9	120	15	0.3	YOHW 0602..	3006-M1.8X4	82-T06	
AHFM-YO0602-D10-C10-L080-Z02-F	●	10	2	10	80	20	0.3				
AHFM-YO0602-D10-C10-L120-Z02-F	●	10	2	10	120	60	0.3				
AHFM-YO0602-D10-C10-L120-Z02-H-F	●	10	2	10	120	60	0.3				
AHFM-YO0602-D10-C10-L120-Z02-H	●	10	2	10	120	60	0.3				
AHFM-YO0602-D12-C11-L120-Z02-F	●	12	2	11	120	15	0.3				
AHFM-YO0602-D12-C11-L120-Z02-H-F	●	12	2	11	120	15	0.3				
AHFM-YO0602-D12-C11-L120-Z02-H	●	12	2	11	120	15	0.3				
AHFM-YO0602-D12-C11-L120-Z03-F	●	12	3	11	120	15	0.3				
AHFM-YO0602-D12-C12-L080-Z02-F	●	12	2	12	80	20	0.3				
AHFM-YO0602-D12-C12-L080-Z03-F	●	12	3	12	80	20	0.3				
AHFM-YO0602-D12-C12-L120-Z02-F	●	12	2	12	120	60	0.3				
AHFM-YO0602-D12-C12-L120-Z02-H	●	12	2	12	120	60	0.3				
AHFM-YO0602-D12-C12-L120-Z03-F	●	12	3	12	120	60	0.3				
AHFM-YO0602-D12-C12-L120-Z03-H	●	12	3	12	120	60	0.3				

DJT Ucuna Uygunudur. / Compatible with DJT Insert. / Под пластину DJT

F: Eksenel ve Radyal Salgı Değeri 0,02 mm içindedir. / F: Axial and radial runout value is within 0,02mm / F: значение радиального и осевого биения в пределах 0,02 мм.

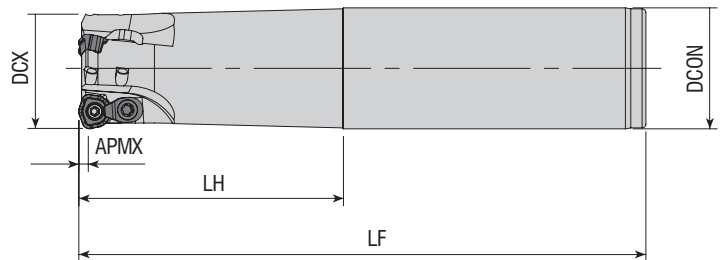

Takım Kodu Ordering Code Код для заказа	Stok Stock Наличие	Takım Ölçüleri (mm) Dimension (mm) Размеры (мм)						Kesici Uç Insert Пластина	Yedek Parçaları / Spare Parts / Запасные части			
		DCX	ZEFP	DCON	LF	LH	APMX		Sıkma Vidası Screw Зажимной винт	Baskı Parçası Wedge Clamp Прижим	Baskı Vidası Clamp Screw Зажимной винт	Tork Anahtar Torx Key Торх Ключ
AHFM-WD0603-D16-C16-L150-Z02	●	16	2	16	150	70	2	WDMT 0603..	3008-M2.5x6	-	-	82-T08
AHFM-WD0603-D20-C20-L150-Z03	●	20	3	20	150	70	2	WDMT 0603..	3008-M2.5x6	-	-	82-T08
AHFMC-WD0804-D25-C25-L150-Z02	●	25	2	25	150	70	1.5	WDMT 0804..	4010-M3X8	ACK-15	4010-M3x8	82-T10
AHFMC-WD0804-D32-C32-L150-Z03	●	32	3	32	150	70	1.5	WDMT 0804..	4010-M3X8	ACK-15	4010-M3x8	82-T10
AHFMC-WD1205-D32-C32-L150-Z02	●	32	2	32	150	70	3	WDMT 1205..	1415-M4x11	ACK-05	4015-M4x11	80-T15

R: Sağ / Right / Правый L: Sol / Left / Левый

● Stokta / In Stock / В наличии ○ Stokta Yok / Non Stock Item / Нет в наличии

SMTM Ucuna Uygunudur. / Compatible with SMTM Insert. / Под пластину SMTM.

Sipariş Örneği/Ordering Example/Образец заказа

1 ad./pcs./шт. AHFM-YO0602-D10-C09-L120-Z02-F

Kesme Hesabı : S 377 / Cutting Calculation : P 377 / Расчет режимов резания: стр. 377

S-SİSTEM HIZLI İLERLEMELİ PARMAK FREZELER
S-SYSTEM HIGHFEED END MILLS
S-ТИП ВЫСОКОПРОИЗВОДИТЕЛЬНЫЕ КОНЦЕВЫЕ ФРЕЗЫ

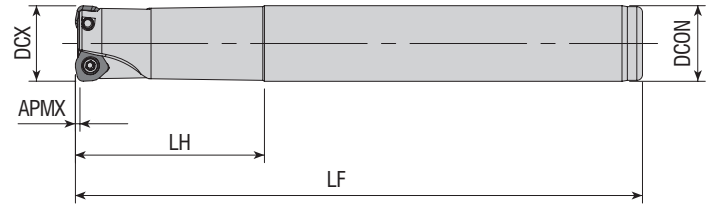

Takım Kodu Ordering Code Код для заказа	Stok Stock Наличие	Takım Ölçüleri (mm) Dimension (mm) Размеры (мм)						Kesici Uç Insert Пластина	Yedek Parçaları / Spare Parts / Запасные части			
		DCX	ZEFP	DCON	LF	LH	APMX		Sıkma Vidası Screw Зажимной винт	Baskı Parçası Wedge Clamp Прижим	Baskı Vidası Clamp Screw Зажимной винт	Tork Anahtar Torx Key Торк Ключ
AHFM-WD0503D-D20-C20-L150-Z02	●	20	2	20	150	50	1.25	WD.W 0503..	4010-M3x6	-	-	82-T10
AHFM-WD0503D-D21-C20-L150-Z02	●	21	2	20	150	30	1.25					
AHFMC-WD06T3D-D26-C25-L200-Z02	●	26	2	25	200	30	1.5	WD.W 06T3..	3015-M3.5x9	ACK-15	4015-M3.5x11	80-T15
AHFMC-WD06T3D-D33-C32-L200-Z03	●	33	3	32	200	32	1.5					

DJT Ucuna Uygundur. / Compatible with DJT Insert. / Под пластину DJT

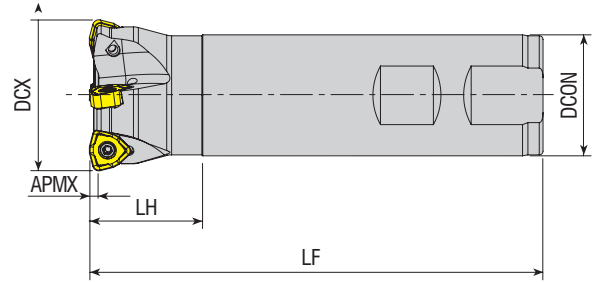

Takım Kodu Ordering Code Код для заказа	Stok Stock Наличие	Takım Ölçüleri (mm) Dimension (mm) Размеры (мм)						Kesici Uç Insert Пластина	Yedek Parçaları / Spare Parts / Запасные части	
		DCX	ZEFP	DCON	LF	LH	APMX		Sıkma Vidası Screw Зажимной винт	Tork Anahtar Torx Key Торк Ключ
AHFM-WN0603-D16-C16-L110-Z02-H	●	16	2	16	110	30	1	WNMX 0603..	3008-M2.5x6	82-T08
AHFM-WN0603-D16-C16-L150-Z02-H	●	16	2	16	150	70	1			
AHFM-WN0603-D17-C16-L150-Z02-H	●	17	2	16	150	20	1			
AHFM-WN0603-D20-C20-L150-Z02-H	●	20	2	20	150	70	1			
AHFM-WN0603-D20-C20-L200-Z02-H	●	20	2	20	200	100	1			
AHFM-WN0603-D21-C20-L150-Z02-H	●	21	2	20	150	20	1	WNMX 09T3..	4010-M3x8	82-T10
AHFM-WN09T3-D25-W25-L120-Z02-H	●	25	2	25	120	40	1.5			
AHFML-WN09T3-D25-W25-L120-Z02-H	●	25	2	25	120	40	1.5			
AHFM-WN09T3-D25-C25-L200-Z02	●	25	2	25	200	120	1.5			
AHFM-WN09T3-D32-W32-L120-Z03-H	●	32	3	32	120	30	1.5			
AHFM-WN09T3-D32-W32-L200-Z03-H	○	32	3	32	200	100	1.5			
AHFM-WN09T3-D35-W32-L200-Z04-H	●	35	4	32	200	50	1.5			
AHFM-WN09T3-D40-W32-L120-Z04-H	●	40	4	32	120	30	1.5			
AHFM-WN09T3-D40-C32-L200-Z04	●	40	4	32	200	30	1.5			
AHFM-WN1305-D32-C32-L150-Z02-H	○	32	2	32	150	70	2			
AHFM-WN1305-D32-C32-L200-Z02-H	●	32	2	32	200	120	2			
AHFM-WN1305-D40-C32-L200-Z03-H	●	40	3	32	200	30	2			

R: Sağ / Right / Правый L: Sol / Left / Левый
 ● Stokta / In Stock / В наличии ○ Stokta Yok / Non Stock Item / Нет в наличии
 KRYL Ucuna Uygundur. / Compatible with KRYL Insert. / Под пластину KRYL

Sipariş Örneği/Ordering Example/Образец заказа
 1 ad./pcs./шт. AHFM-WD0503D-D20-C20-L150-Z02
 Kesme Hesabı : S 377 / Cutting Calculation : P 377 / Расчет режимов резания: стр. 377



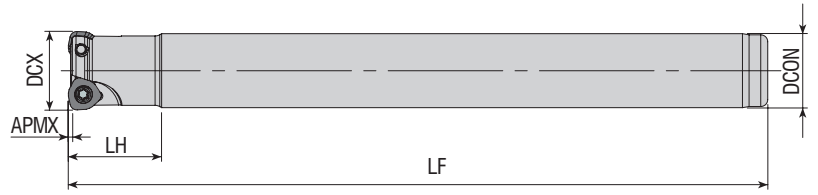

Takım Kodu Ordering Code Код для заказа	Stok Stock Наличие	Takım Ölçüleri (mm) Dimension (mm) Размеры (мм)						Kesici Uç Insert Пластина	Yedek Parçaları / Spare Parts / Запасные части		
		DCX	ZEFP	DCON	LF	LH	APMX		Sıkma Vidası Screw Зажимной винт	Tork Anahtar Torx Key Торх Ключ	
AHFM-W004T2D-D16-C16-L150-Z02	●	16	2	16	150	20	0.8	WOMW 04T2..		3008-M2.5x6	
AHFM-W004T2D-D17-C16-L150-Z02	●	17	2	16	150	20	0.8				

DJT Ucuna Uygunudur. / Compatible with DJT Insert. / Под пластину DJT

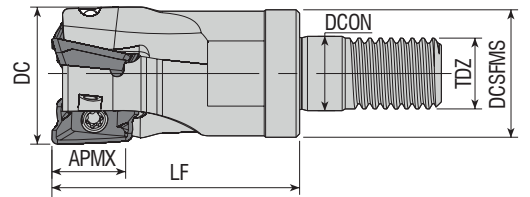
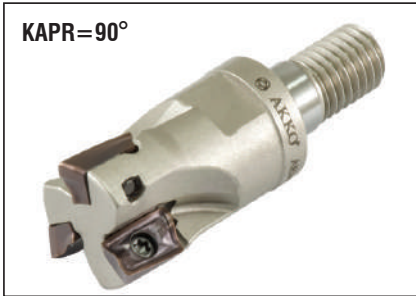

Takım Kodu Ordering Code Код для заказа	Stok Stock Наличие	Takım Ölçüleri (mm) Dimension (mm) Размеры (мм)							Kesici Uç Insert Пластина	Yedek Parçaları / Spare Parts / Запасные части		
		DC	Z	DCSFMS	TDZ	LF	DCON	APMX		Sıkma Vidası Screw Зажимной винт	Tork Anahtar Torx Key Торх Ключ	
AEM90-A01236-D16-M08-L30-Z02	●	16	2	14.8	M08	30	8.5	10	A0.. 1236..			
AEM90-A01236-D20-M10-L35-Z03	●	20	3	18	M10	35	10.5	10				

R: Sağ / Right / Правый L: Sol / Left / Левый
● Stokta / In Stock / В наличии ○ Stokta Yok / Non Stock Item / Нет в наличии
MTSBH Ucuna Uygunudur. / Compatible with MTSBH Insert. / Под пластину MTSBH.

Sipariş Örneği/Ordering Example/Образец заказа
1 ad./pcs./шт. AHFM-W004T2D-D16-C16-L150-Z02
Kesme Hesabı : S 377 / Cutting Calculation : P 377 / Расчет режимов резания: стр. 377
Sıkma Tork Değeri : S 376 / Tightening Torque : P 376 / Момент затяжки: стр. 376

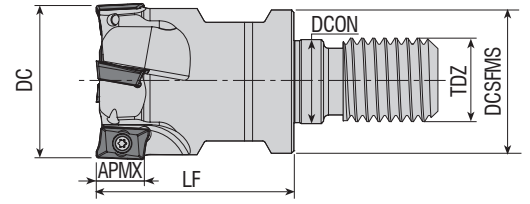

Takım Kodu Ordering Code Код для заказа	Stok Stock Наличие	Takım Ölçüleri (mm) Dimension (mm) Размеры (мм)							Kesici Uç Insert Пластина	Yedek Parçaları / Spare Parts / Запасные части		
		DC	ZEPF	DCSFMS	TDZ	LF	DCON	APMX		Sıkma Vidası Screw Зажимной винт	Tork Anahtar Torx Key Торх Ключ	
AEM90-AD1505D-D25-M12-L43-Z02-H	●	25	2	21	M12	43	12.5	14.3	ADKT 150508	4015-M4x9 4015-M4x11	80-T15	
AEM90-AD1505D-D32-M16-L43-Z03-H	●	32	3	29	M16	43	17	14.3				

DJT Ucuna Uygun. / Compatible with DJT Insert. / Под пластину DJT

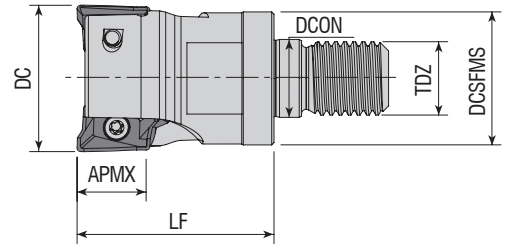

Takım Kodu Ordering Code Код для заказа	Stok Stock Наличие	Takım Ölçüleri (mm) Dimension (mm) Размеры (мм)							Kesici Uç Insert Пластина	Yedek Parçaları / Spare Parts / Запасные части		
		DC	ZEPF	DCSFMS	TDZ	LF	DCON	APMX		Sıkma Vidası Screw Зажимной винт	Tork Anahtar Torx Key Торх Ключ	
AEM90-AX1235-D16-M08-L30-Z02-H	●	16	2	14.75	M08	30	8.5	10	AX.T 1235..	3108-M3x6	82-T08	
AEM90-AX1235-D20-M10-L30-Z03-H	●	20	3	18	M10	30	10.5	10				
AEM90-AX1235-D25-M12-L35-Z04-H	●	25	4	21	M12	35	12.5	10	AX.T 1705..	4015-M4x9	80-T15	
AEM90-AX1705-D25-M12-L43-Z02-H	●	25	2	21	M12	43	12.5	14				
AEM90-AX1705-D32-M16-L43-Z02-H	●	32	2	29	M16	43	17	14				

R: Sağ / Right / Правый L: Sol / Left / Левый

● Stokta / In Stock / В наличии ○ Stokta Yok / Non Stock Item / Нет в наличии
SMTM Ucuna Uygun. / Compatible with SMTM Insert. / Под пластину SMTM.

Sipariş Örneği/Ordering Example/Образец заказа

1 ad./pcs./шт. AEM90-AD1505D-D25-M12-L43-Z02-H

Kesme Hesabı : S 377/ Cutting Calculation : P 377 / Расчет режимов резания: стр. 377

Sıkma Tork Değeri : S 376 / Tightening Torque : P 376 / Момент затяжки: стр. 376

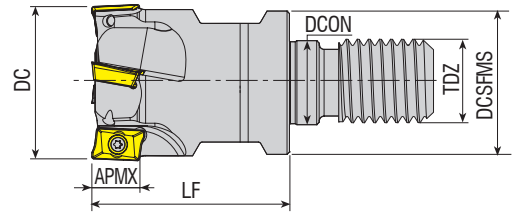
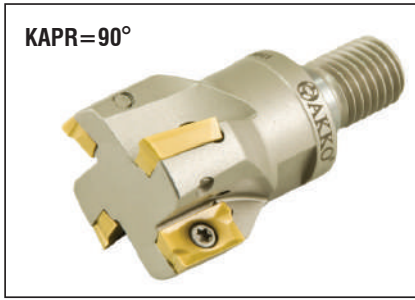

Takım Kodu Ordering Code Код для заказа	Stok Stock Наличие	Takım Ölçüleri (mm) Dimension (mm) Размеры (мм)							Kesici Uç Insert Пластина	Yedek Parçaları / Spare Parts / Запасные части	
		DC	ZEFP	DCSFMS	TDZ	LF	DCON	APMX		Sıkma Vidası Screw Зажимной винт	Tork Anahtar Torx Key Торх Ключ
AEM90-AP0903-D20-M12-L35-Z03	●	20	3	18	M12	35	12.5	9			
AEM90-AP0903-D25-M12-L35-Z03	●	25	3	21	M12	35	12.5	9			
AEM90-AP10-D16-M08-L30-Z02-H	●	16	2	14.75	M08	30	8.5	10		3008-M2.5x6	82-T08
AEM90-AP10-D20-M10-L30-Z03-H	●	20	3	18	M10	30	10.5	10			
AEM90-AP10-D25-M12-L35-Z03-H	●	25	3	21	M12	35	12.5	10			
AEM90-AP10-D32-M16-L35-Z04-H	●	32	4	29	M16	35	17	10			
AEM90-AP10-D32-M16-L40-Z04-H	●	32	4	29	M16	40	17	10			
AEM90-AP10-D40-M16-L43-Z05-H	●	40	5	29	M16	43	17	10			
AEM90-AP10-D42-M16-L43-Z05-H	●	42	5	29	M16	43	17	10			
AEM90-AP10D-D16-M08-L30-Z02-H	●	16	2	14.75	M08	30	8.5	10			
AEM90-AP10D-D20-M10-L30-Z03-H	●	20	3	18	M10	30	10.5	10			
AEM90-AP10D-D25-M12-L35-Z03-H	●	25	3	21	M12	35	12.5	10			
AEM90-AP11-D16-M08-L30-Z02-H	●	16	2	14.75	M08	30	8.5	11			
AEM90-AP11-D20-M10-L30-Z03-H	●	20	3	18	M10	30	10.5	11			
AEM90-AP11-D25-M12-L35-Z03-H	●	25	3	21	M12	35	12.5	11			
AEM90-AP11-D32-M16-L35-Z04-H	●	32	4	29	M16	35	17	11			
AEM90-AP11-D40-M16-L43-Z05-H	●	40	5	29	M16	43	17	11			
AEM90-AP16-D25-M12-L43-Z02-H	●	25	2	21	M12	43	12.5	16		4015-M4x9	80-T15
AEM90-AP16-D32-M16-L43-Z03-H	●	32	3	29	M16	43	17	16			
AEM90-AP16-D40-M16-L43-Z04-H	●	40	4	29	M16	43	17	16			
AEM90-AP16-D42-M16-L43-Z04-H	●	42	4	29	M16	43	17	16			
AEM90-AP16DJ-D25-M12-L43-Z02-H	●	25	2	21	M12	43	12.5	16		4015-M4x9	80-T15
AEM90-AP16DJ-D32-M16-L43-Z03-H	●	32	3	29	M16	43	17	16			
AEM90-AP16DJ-D40-M16-L43-Z04-H	●	40	4	29	M16	43	17	16			
AEM90-AP16L-D25-M12-L43-Z02-H	●	25	2	21	M12	43	12.5	16		4015-M4x9	80-T15
AEM90-AP16L-D32-M16-L43-Z03-H	●	32	3	29	M16	43	17	16			
AEM90-AP16L-D40-M16-L43-Z04-H	●	40	4	29	M16	43	17	16			

R: Sağ / Right / Правый L: Sol / Left / Левый

● Stokta / In Stock / В наличии ○ Stokta Yok / Non Stock Item / Нет в наличии

Sipariş Örneği/Ordering Example/Образец заказа

1 ad./pcs./шт. AEM90-AP0903-D20-M12-L35-Z03

Kesme Hesabı : S 377 / Cutting Calculation : P 377 / Расчет режимов резания: стр. 377

Sıkma Tork Değeri : S 376 / Tightening Torque : P 376 / Момент затяжки: стр. 376

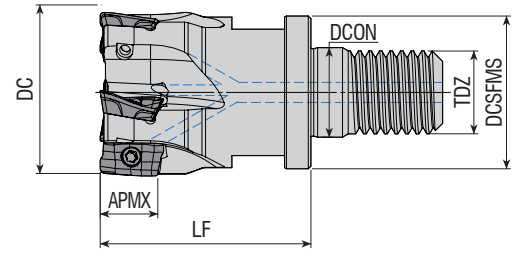

Takım Kodu Ordering Code Код для заказа	Stok Stock Наличие	Takım Ölçüleri (mm) Dimension (mm) Размеры (мм)							Kesici Uç Insert Пластина	Yedek Parçaları / Spare Parts / Запасные части	
		DC	ZEPF	DCSFMS	TDZ	LF	DCON	APMX		Sıkma Vidası Screw Зажимной винт	Tork Anahtar Torx Key Торх Ключ
AEM90-BD11T3-D16-M08-L25-Z02-H	●	16	2	14.75	M08	25	8.5	10	BDMT 11T3..	3008-M2.5x6	82-T08
AEM90-BD11T3-D25-M12-L35-Z04-H	●	25	4	21	M12	35	12.5	10			
AEM90-BD11T3-D32-M16-L40-Z05-H	●	32	5	29	M16	40	17	10			

KYCR Ucuna Uygundur. / Compatible with KYCR Insert. / Под пластину KYCR

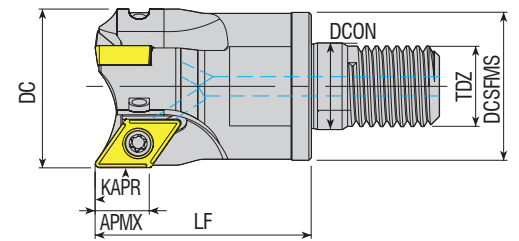

Takım Kodu Ordering Code Код для заказа	Stok Stock Наличие	Takım Ölçüleri (mm) Dimension (mm) Размеры (мм)							Kesici Uç Insert Пластина	Yedek Parçaları / Spare Parts / Запасные части	
		DC	ZEPF	DCSFMS	TDZ	LF	DCON	APMX		Sıkma Vidası Screw Зажимной винт	Tork Anahtar Torx Key Торх Ключ
AEM90-DC07-D20-M10-L30-Z02-H	●	20	2	18	M10	30	10.5	7	DC.T 0702..	3008-M2.5x6	82-T08
AEM90-DC07-D25-M12-L35-Z03-H	●	25	3	21	M12	35	12.5	7			
AEM90-DC07-D32-M16-L43-Z04-H	●	32	4	29	M16	43	17	7			
AEM90-DC07-D40-M16-L43-Z05-H	●	40	5	29	M16	43	17	7			
AEM90-DC11-D32-M16-L43-Z03-H-F	●	32	3	29	M16	43	17	11	DC.T 11T3..	4015-M3.5x9	80-T15
AEM90-DC11-D40-M16-L43-Z03-H-F	●	40	3	29	M16	43	17	11			

R: Sağ / Right / Правый L: Sol / Left / Левый



● Stokta / In Stock / В наличии ○ Stokta Yok / Non Stock Item / Нет в наличии

ISO Ucuna Uygundur. / Compatible with ISO Insert. / Под пластину ISO.

F: Eksenel ve Radyal Salgi Değeri 0,02 mm içindedir. / F: Axial and Radial Runout Value is within 0,02 mm. / F: значение радиального и осевого биения в пределах 0,02 мм.

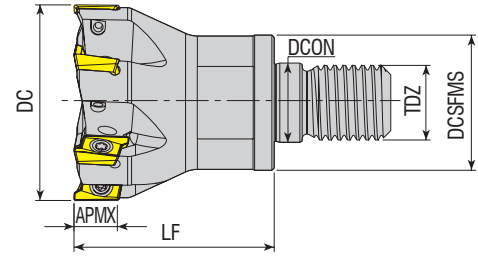

Sipariş Örneği/Ordering Example/Образец заказа
 1 ad./pcs./шт. AEM90-BD11T3-D16-M08-L25-Z02-H

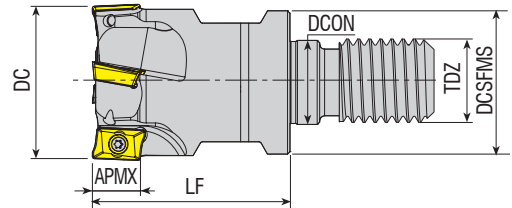

Takım Kodu Ordering Code Код для заказа	Stok Stock Наличие	Takım Ölçüleri (mm) Dimension (mm) Размеры (мм)							Kesici Uç Insert Пластина	Yedek Parçaları / Spare Parts / Запасные части	
		DC	ZEFP	DCSFMS	TDZ	LF	DCON	APMX		Sıkma Vidası Screw Зажимной винт	Tork Anahtar Torx Key Торх Ключ
AEM90-RT10-D16-M08-L20-Z02-H	●	16	2	14.75	M08	20	8.5	10			
AEM90-RT10-D20-M10-L25-Z03-H	●	20	3	18	M10	25	10.5	10			
AEM90-RT10-D25-M12-L30-Z04-H	●	25	4	21	M12	30	12.5	10			
AEM90-RT10-D32-M16-L43-Z05-H	●	32	5	29	M16	43	17	10			
AEM90-RT10-D42-M16-L43-Z06-H	●	42	6	29	M16	43	17	10			

SFTY Ucuna Uygundur. / Compatible with SFTY Insert. / Под пластину SFTY



Takım Kodu Ordering Code Код для заказа	Stok Stock Наличие	Takım Ölçüleri (mm) Dimension (mm) Размеры (мм)							Kesici Uç Insert Пластина	Yedek Parçaları / Spare Parts / Запасные части	
		DC	ZEFP	DCSFMS	TDZ	LF	DCON	APMX		Sıkma Vidası Screw Зажимной винт	Tork Anahtar Torx Key Торх Ключ
AEM90-R390.11-D16-M08-L30-Z02-H	●	16	2	14.75	M08	30	8.5	10		3008-M2.5x5	
AEM90-R390.11-D20-M10-L30-Z03-H	●	20	3	18	M10	30	10.5	10			
AEM90-R390.11-D25-M12-L35-Z03-H	●	25	3	21	M12	35	12.5	10			
AEM90-R390.11-D32-M16-L43-Z04-H	●	32	4	29	M16	43	17	10			
AEM90-R390.11-D42-M16-L43-Z06-H	●	42	6	29	M16	43	17	10			

R: Sağ / Right / Правый L: Sol / Left / Левый

● Stokta / In Stock / В наличии ○ Stokta Yok / Non Stock Item / Нет в наличии

SNDVK Ucuna Uygundur. / Compatible with SNDVK Insert. / Под пластину SNDVK

Sipariş Örneği/Ordering Example/Образец заказа
1 ad./pcs./шт. AEM90-RT10-D16-M08-L20-Z02-H

S-SİSTEM MODÜLER PARMAK FREZELER
S-SYSTEM MODULAR END MILLS (SCREW TYPE TOOLS)
S-ТИП СМЕННЫЕ ФРЕЗЕРНЫЕ ГОЛОВКИ (КРЕПЛЕНИЕ ПОД РЕЗЬБУ)

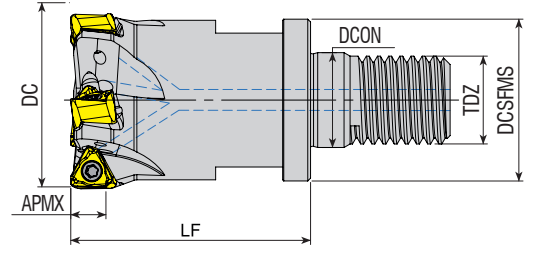

Takım Kodu Ordering Code Код для заказа	Stok Stock Наличие	Takım Ölçüleri (mm) Dimension (mm) Размеры (мм)							Kesici Uç Insert Пластина	Yedek Parçaları / Spare Parts / Запасные части		
		DC	ZEFP	DCSFMS	TDZ	LF	DCON	APMX		Sıkma Vidası Screw Зажимной винт	Tork Anahtar Torx Key Торх Ключ	
• new • AEM90-TNG10-D20-M10-L26-Z02-H	●	20	2	18	M10	26	10.5	5	TNGX 1004..	3008-M2.5x6	82-T08	
• new • AEM90-TNG10-D20-M10-L26-Z03-H	●	20	3	18	M10	26	10.5	5				
AEM90-TNG10-D21-M10-L25-Z03-H	●	21	3	18	M10	25	10.5	5				
• new • AEM90-TNG10-D25-M12-L33-Z03-H	●	25	3	21	M12	33	12.5	5				
• new • AEM90-TNG10-D25-M12-L33-Z04-H	●	25	4	21	M12	33	12.5	5				
AEM90-TNG10-D26-M12-L30-Z04-H	●	26	4	21	M12	30	12.5	5				
• new • AEM90-TNG10-D32-M16-L43-Z04-H	●	32	4	29	M16	43	17	5				
• new • AEM90-TNG10-D32-M16-L43-Z05-H	●	32	5	29	M16	43	17	5				
AEM90-TNG10-D33-M16-L43-Z05-H	●	33	5	29	M16	43	17	5				
AEM90-TNG10-D35-M16-L43-Z05-H	●	35	5	29	M16	43	17	5				

PRMT Ucuna Uygun. / Compatible with PRMT Insert. / Под пластину PRMT.

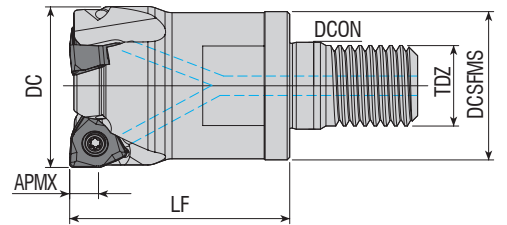



Takım Kodu Ordering Code Код для заказа	Stok Stock Наличие	Takım Ölçüleri (mm) Dimension (mm) Размеры (мм)							Kesici Uç Insert Пластина	Yedek Parçaları / Spare Parts / Запасные части		
		DC	ZEFP	DCSFMS	TDZ	LF	DCON	APMX		Sıkma Vidası Screw Зажимной винт	Tork Anahtar Torx Key Торх Ключ	
AEM90-WN0604Z-D25-M12-L35-Z02-H	●	25	2	21	M12	35	12.5	5.7	WNHU 0604..	3008-M3x8	82-T08	
AEM90-WN0604Z-D32-M16-L43-Z03-H	●	32	3	29	M16	43	17	5.7				
AEM90-WN0604Z-D40-M16-L43-Z04-H	●	40	4	29	M16	43	17	5.7				

R: Sağ / Right / Правый L: Sol / Left / Левый
 ● Stokta / In Stock / В наличии ○ Stokta Yok / Non Stock Item / Нет в наличии
 ZCC Ucuna Uygun. / Compatible with ZCC Insert. / Под пластину ZCC

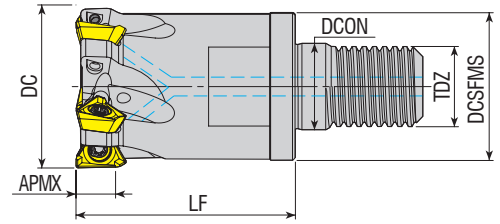

Sipariş Örneği/Ordering Example/Образец заказа
 1 ad./pcs./шт. AEM90-TNG10-D20-M10-L26-Z02-H
 Kesme Hesabı : S 377 / Cutting Calculation : P 377 / Расчет режимов резания: стр. 377
 Sıkma Tork Değeri : S 376 / Tightening Torque : P 376 / Момент затяжки: стр. 376

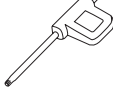

Takım Kodu Ordering Code Код для заказа	Stok Stock Наличие	Takım Ölçüleri (mm) Dimension (mm) Размеры (мм)							Kesici Uç Insert Пластина	Yedek Parçaları / Spare Parts / Запасные части	
		DC	ZEFP	DCSFMS	TDZ	LF	DCON	APMX		Sıkma Vidası Screw Зажимной винт	Tork Anahtar Torx Key Торх Ключ
AEM90-3P1004-D20-M10-L35-Z02	●	20	2	18	M10	35	10.5	7			
AEM90-3P1004-D32-M16-L43-Z05-H	●	32	5	29	M16	43	17	7			

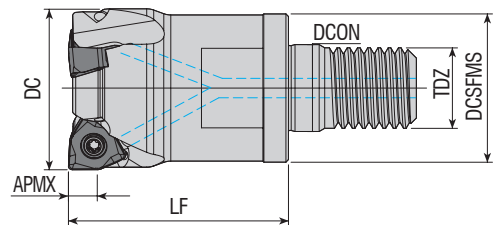
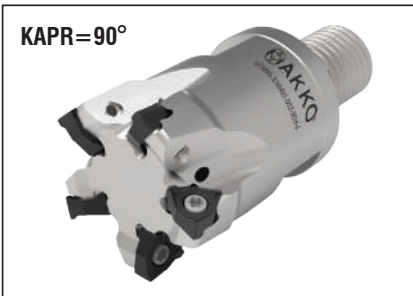
TGTC Ucuna Uygun. / Compatible with TGTC Insert. / Под пластину TGTC.

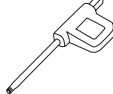

Takım Kodu Ordering Code Код для заказа	Stok Stock Наличие	Takım Ölçüleri (mm) Dimension (mm) Размеры (мм)							Kesici Uç Insert Пластина	Yedek Parçaları / Spare Parts / Запасные части	
		DC	ZEFP	DCSFMS	TDZ	LF	DCON	APMX		Sıkma Vidası Screw Зажимной винт	Tork Anahtar Torx Key Торх Ключ
AEM90-XN0403-D32-M16-L43-Z05-H	●	32	5	29	M16	43	17	4			
AEM90-XN0403-D42-M16-L43-Z06-H	●	42	6	29	M16	43	17	4			

R: Sağ / Right / Правый L: Sol / Left / Левый
● Stokta / In Stock / В наличии ○ Stokta Yok / Non Stock Item / Нет в наличии
SC Ucuna Uygun. / Compatible with SC Insert. / Под пластину SC.

Sipariş Örneği/Ordering Example/Образец заказа
1 ad./pcs./шт. AEM90-3P1004-D20-M10-L35-Z02
Kesme Hesabı : S 377 / Cutting Calculation : P 377 / Расчет режимов резания: стр. 377

S-SİSTEM MODÜLER PARMAK FREZELER

S-SYSTEM MODULAR END MILLS (SCREW TYPE TOOLS)

S-ТИП СМЕННЫЕ ФРЕЗЕРНЫЕ ГОЛОВКИ (КРЕПЛЕНИЕ ПОД РЕЗЬБУ)

KAPR=95°

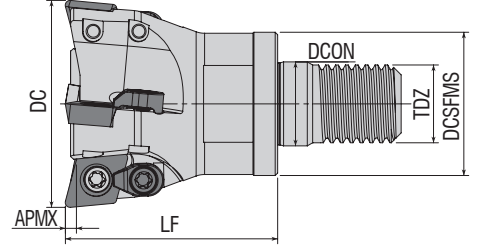

Takım Kodu Ordering Code Код для заказа	Stok Stock Наличие	Takım Ölçüleri (mm) Dimension (mm) Размеры (мм)						Kesici Uç Insert Пластина	Yedek Parçaları / Spare Parts / Запасные части				
		DC	ZEFP	DCSFMS	TDZ	LF	DCON		APMX	Sıkma Vidası Screw Зажимной винт	Baskı Parçası Wedge Clamp Прижим	Baskı Vidası Clamp Screw Зажимной винт	Tork Anahtar Torx Key Торх Ключ
AEM95-XD0206-D16-M08-L23-Z02-H	●	16	2	14.75	M08	23	8.5	1	XDHW 0206..		-	-	82-T08
AEM95-XD0206-D16-M08-L23-Z02-H-F	●	16	2	14.75	M08	23	8.5	1					
AEM95-XD0206-D20-M10-L30-Z03-H	●	20	3	18	M10	30	10.5	1					
AEM95-XD0206-D20-M10-L30-Z03-H-F	●	20	3	18	M10	30	10.5	1					
AEM95-XD0206-D25-M12-L35-Z03-H	●	25	3	21	M12	35	12.5	1					
AEM95-XD0206-D25-M12-L35-Z03-H-F	●	25	3	21	M12	35	12.5	1					
AEM95C-XD0310-D35-M16-L43-Z03-H	●	35	3	29	M16	43	17	1.5	XDHW 0310..		ACK-15	4015-M3.5x11	80-T15
AEM95C-XD0310-D35-M16-L43-Z03-H-F	●	35	3	29	M16	43	17	1.5					
AEM95C-XD0310-D42-M16-L43-Z04-H	●	42	4	29	M16	43	17	1.5					
AEM95C-XD0310-D42-M16-L43-Z04-H-F	●	42	4	29	M16	43	17	1.5					

DJT Ucuna Uygunudur. / Compatible with DJT Insert. / Под пластину DJT

Çap Ölçüsü - 0,02 mm Olarak üretiliyor. F: ± 0,02 mm Demektir. Ör: Ø16 Takım 15,98 ± 0,02 mm yani 16,00 mm - 15,96 mm Olmalıdır.

Diameter Size is produced as - 0.02 mm. F: means ± 0,02 mm. For example: Ø16 tool 15,98 ± 0,02 mm, it means that it should be 16,00 mm - 15,96 mm.

Размер диаметра составляет -0,02 мм. F: означает ± 0,02 мм. Например: Ø16 инструмент 15,98 ± 0,02 мм, должно быть 16,00мм - 15,96 мм.

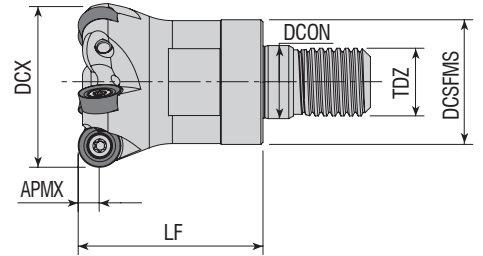

Takım Kodu Ordering Code Код для заказа	Stok Stock Наличие	Takım Ölçüleri (mm) Dimension (mm) Размеры (мм)						Kesici Uç Insert Пластина	Yedek Parçaları / Spare Parts / Запасные части			
		DCX	ZEFP	DCSFMS	TDZ	LF	DCON		APMX	Sıkma Vidası Screw Зажимной винт	Tork Anahtar Torx Key Торх Ключ	
AEMR-RC10T3-D25-M12-L35-Z03-H	●	25	3	21	M12	35	12.5	5	RC.. 10T3..		4015-M4x9	80-T15
AEMR-RC10T3-D32-M16-L43-Z04-H	●	32	4	29	M16	43	17	5				
AEMR-RC10T3-D40-M16-L43-Z05-H	●	40	5	29	M16	43	17	5				

ZCC Ucuna Uygunudur. / Compatible with ZCC Insert. / Под пластину ZCC

Sipariş Örneği/Ordering Example/Образец заказа

1 ad./pcs./шт. AEM95-XD0206-D16-M08-L23-Z02-H

Kesme Hesabı : S 367 / Cutting Calculation : P 367 / Расчет режимов резания: стр. 367

Sıkma Tork Değeri : S 376 / Tightening Torque : P 376 / Момент затяжки: стр. 376



www.akkо.com.tr

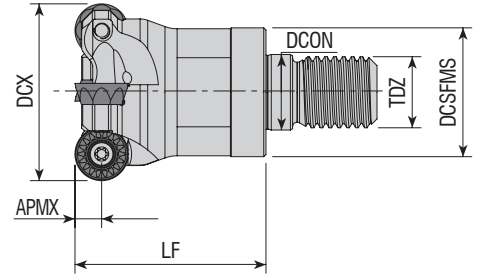

Takım Kodu Ordering Code Код для заказа	Stok Stock Наличие	Takım Ölçüleri (mm) Dimension (mm) Размеры (мм)							Kesici Uç Insert Пластина	Yedek Parçaları / Spare Parts / Запасные части	
		DCX	ZEFP	DCSFMS	TDZ	LF	DCON	APMX		Sıkma Vidası Screw Зажимной винт	Tork Anahtar Torx Key Торк Ключ
AEMR-RP08T2M-D20-M10-L30-Z02-H	●	20	2	18	M10	30	10.5	4		3008-M2.5x6	82-T08
AEMR-RP10T3M-D25-M12-L35-Z02-H	●	25	2	21	M12	35	12.5	5	RPMT 10T3..	4015-M3.5x9	80-T15
AEMR-RP10T3M-D32-M16-L43-Z03-H	●	32	3	29	M16	43	17	5			
AEMR-RP1204M-D32-M16-L43-Z03-H	●	32	3	29	M16	43	17	6	RPMT 1204..	4015-M4x9	
AEMR-RP1204M-D40-M16-L43-Z04-H	●	40	4	29	M16	43	17	6			

MTSBH Ucuna Uygunudur. / Compatible with MTSBH Insert. / Под пластину MTSBH

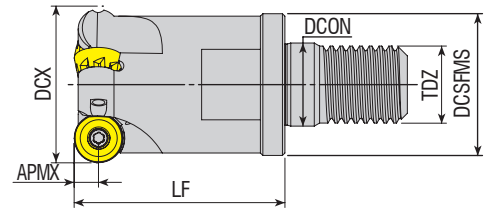

Takım Kodu Ordering Code Код для заказа	Stok Stock Наличие	Takım Ölçüleri (mm) Dimension (mm) Размеры (мм)							Kesici Uç Insert Пластина	Yedek Parçaları / Spare Parts / Запасные части	
		DCX	ZEFP	DCSFMS	TDZ	LF	DCON	APMX		Sıkma Vidası Screw Зажимной винт	Tork Anahtar Torx Key Торк Ключ
AEMR-RP10T3-D25-M12-L35-Z02-H	●	25	2	21	M12	35	12.5	5	RPNX 10T3..	4010-M3x8	82-T10
AEMR-RP10T3-D32-M16-L43-Z03-H	●	32	3	29	M16	43	17	5			
AEMR-RP1204-D32-M16-L43-Z03-H	●	32	3	29	M16	43	17	6	RPNX 1204..	4015-M4x9	80-T15

R: Sağ / Right / Правый L: Sol / Left / Левый

● Stokta / In Stock / В наличии ○ Stokta Yok / Non Stock Item / Нет в наличии

CRTZT Ucuna Uygunudur. / Compatible with CRTZT Insert. / Под пластину CRTZT

Sipariş Örneği/Ordering Example/Образец заказа

1 ad./pcs./шт. AEMR-RP08T2M-D20-M10-L30-Z02-H

Kesme Hesabı : S 367 / Cutting Calculation : P 367 / Расчет режимов резания: стр. 367

Sıkma Tork Değeri : S 367 / Tightening Torque : P 367 / Момент затяжки: стр. 367

S-SİSTEM MODÜLER PARMAK FREZELER
S-SYSTEM MODULAR END MILLS (SCREW TYPE TOOLS)
S-ТИП СМЕННЫЕ ФРЕЗЕРНЫЕ ГОЛОВКИ (КРЕПЛЕНИЕ ПОД РЕЗЬБУ)

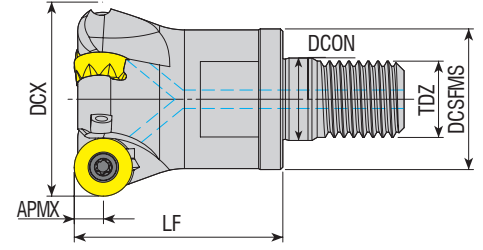

Takım Kodu Ordering Code Код для заказа	Stok Stock Наличие	Takım Ölçüleri (mm) Dimension (mm) Размеры (мм)							Kesici Uç Insert Пластина	Yedek Parçaları / Spare Parts / Запасные части		
		DCX	ZEP	DCSFMS	TDZ	LF	DCON	APMX		Sıkma Vidası Screw Зажимной винт	Baskı Parçası Wedge Clamp Прижим	Baskı Vidası Clamp Screw Зажимной винт
new AEMR-RY10-D25-M12-L43-Z03-H	●	25	3	21	M12	43	12.5	5	RYMX 1004..	4015-M3.5x9	80-T15	
AEMR-RY10-D32-M16-L43-Z04-H	●	32	4	29	M16	43	17	5				
AEMR-RY10-D40-M16-L43-Z05-H	●	40	5	29	M16	43	17	5				
AEMR-RY12-D32-M16-L43-Z03-H	●	32	3	29	M16	43	17	6	RYMX 1205..	4015-M4x9	80-T15	
AEMR-RY12-D40-M16-L43-Z03-H	●	40	3	29	M16	43	17	6				

TGTC Uçuna Uygundur. / Compatible with TGTC Insert. / Под пластину TGTC.

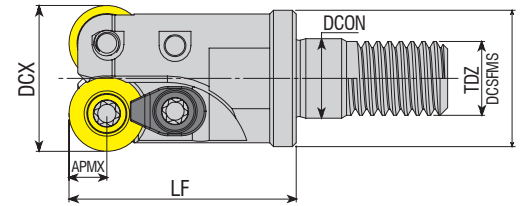

Takım Kodu Ordering Code Код для заказа	Stok Stock Наличие	Takım Ölçüleri (mm) Dimension (mm) Размеры (мм)							Kesici Uç Insert Пластина	Yedek Parçaları / Spare Parts / Запасные части			
		DCX	ZEP	DCSFMS	TDZ	LF	DCON	APMX		Sıkma Vidası Screw Зажимной винт	Baskı Parçası Wedge Clamp Прижим	Baskı Vidası Clamp Screw Зажимной винт	Tork Anahtar Torx Key Торх Ключ
AEMRC-RD10T3-D20-M10-L30-Z02	●	20	2	18	M10	30	10.5	5	RD.. 10T3	4015-M3.5x9	ACK-15	4015-M3.5x11	80-T15
AEMRC-RD10T3-D32-M16-L43-Z03-H	●	32	3	29	M16	43	17	5					

R: Sağ / Right / Правый L: Sol / Left / Левый
 ● Stokta / In Stock / В наличии ○ Stokta Yok / Non Stock Item / Нет в наличии
 ISO Uçuna Uygundur. / Compatible with ISO Insert. / Под пластину ISO.

Sipariş Örneği/Ordering Example/Образец заказа
 1 ad./pcs./шт. AEMR-RY10-D25-M12-L43-Z03-H
 Kesme Hesabı : S 377/ Cutting Calculation : P 377 / Расчет режимов резания: стр. 377

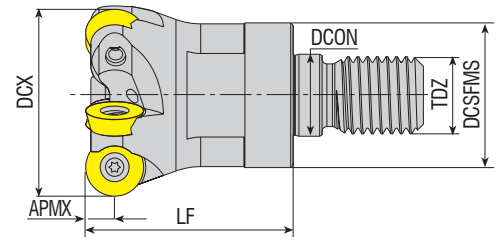
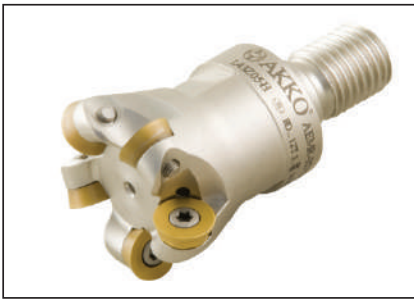

Takım Kodu
Ordering Code
Код для заказа

Stok
Stock
Наличие

Takım Ölçüleri (mm)
Dimension (mm)
Размеры (мм)

Kesici Uç
Insert
Пластина

Yedek Parçaları / Spare Parts / Запасные части

Sıkma Vidası
Screw
Зажимной винт

Tork Anahtar
Torx Key
Торк Ключ

DCX ZEFP DCSFMS TDZ LF DCON APMX

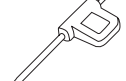

AEMR-RD0702-D15-M08-L23-Z02-H	●	15	2	13	M08	23	8.5	3.5	RD.. 0702	3008-M2.5x6	82-T08						
AEMR-RD0702-D16-M08-L23-Z02-H	●	16	2	14.75	M08	23	8.5	3.5									
AEMR-RD0702-D20-M10-L30-Z04-H	●	20	4	18	M10	30	10.5	3.5									
AEMR-RD0702-D25-M12-L35-Z05-H	●	25	5	21	M12	35	12.5	3.5									
AEMR-RD0702-D30-M16-L42-Z05-H	●	30	5	29	M16	42	17	3.5									
AEMR-RD0702-D32-M16-L43-Z05-H	●	32	5	29	M16	43	17	3.5									
AEMR-RD0702-D35-M16-L42-Z06-H	●	35	6	29	M16	42	17	3.5									
AEMR-RD0702-D42-M16-L43-Z05-H	●	42	5	29	M16	43	17	3.5									
AEMR-RD0702-D42-M16-L43-Z07-H	●	42	7	29	M16	43	17	3.5									
AEMR-RD08T2-D16-M08-L23-Z02-H	●	16	2	13	M08	23	8.5	4				RD.. 08T2	3008-M2.5x6	82-T08			
AEMR-RD08T2-D16-M10-L23-Z02-H	●	16	2	13	M10	23	8.5	4									
AEMR-RD08T2-D20-M10-L30-Z03-H	●	20	3	18	M10	30	10.5	4									
AEMR-RD08T2-D25-M12-L35-Z04-H	●	25	4	21	M12	35	12.5	4									
AEMR-RD0802-D16-M08-L23-Z02-H	●	16	2	13	M08	23	8.5	4	RD.. 0802	3008-M3x6	80-T15						
AEMR-RD0803-D16-M08-L23-Z02-H	●	16	2	13	M08	23	8.5	4									
AEMR-RD0803-D20-M10-L30-Z03-H	●	20	3	18	M10	30	10.5	4	RD.. 0803	3008-M3x8							
AEMR-RD0803-D25-M12-L35-Z04-H	●	25	4	21	M12	35	12.5	4									
AEMR-RD1003-D20-M10-L30-Z02-H	●	20	2	18	M10	30	10.5	5	RD.. 1003	4015-M3.5x9					80-T15		
AEMR-RD1003-D25-M12-L35-Z02-H	●	25	2	21	M12	35	12.5	5									
AEMR-RD1003-D25-M12-L35-Z03-H	●	25	3	21	M12	35	12.5	5									
AEMR-RD1003-D30-M16-L43-Z04-H	●	30	4	29	M16	43	17	5									
AEMR-RD1003-D32-M16-L43-Z04-H	●	32	4	29	M16	43	17	5									
AEMR-RD1003-D35-M16-L43-Z04-H	●	35	4	29	M16	43	17	5									
AEMR-RD1003-D40-M16-L43-Z05-H	●	40	5	29	M16	43	17	5									
AEMR-RD1003-D42-M16-L43-Z05-H	●	42	5	29	M16	43	17	5									
AEMR-RD10T3-D25-M12-L35-Z03-H	●	25	3	21	M12	35	12.5	5			RD.. 10T3	4015-M3.5x9	80-T15				
AEMR-RD10T3-D32-M16-L45-Z04-H	●	32	4	29	M16	45	17	5									
new AEMR-RD10T3-D35-M16-L43-Z04-H	●	35	4	29	M16	43	17	5									
new AEMR-RD10T3-D42-M16-L43-Z05-H	●	42	5	29	M16	43	17	5									
AEMR-RD1004-D25-M12-L35-Z03-H	●	25	3	21	M12	35	12.5	5	RD.. 1004	4515-M4x8				80-T15			
AEMR-RD1004-D32-M16-L43-Z04-H	●	32	4	29	M16	43	17	5									
AEMR-RD1004-D42-M16-L43-Z05-H	●	42	5	29	M16	43	17	5									
AEMR-RD12T3-D24-M12-L35-Z02-H	●	24	2	21	M12	35	12.5	6							RD.. 12T3	4015-M3.5x9	80-T15
AEMR-RD12T3-D25-M12-L35-Z02-H	●	25	2	21	M12	35	12.5	6									
AEMR-RD12T3-D32-M16-L43-Z03-H	●	32	3	29	M16	43	17	6									
AEMR-RD12T3-D35-M16-L43-Z03-H	●	35	3	29	M16	43	17	6									
AEMR-RD12T3-D35-M16-L43-Z04-H	●	35	4	29	M16	43	17	6									
AEMR-RD12T3-D40-M16-L43-Z04-H	●	40	4	29	M16	43	17	6									
AEMR-RD12T3-D42-M16-L43-Z05-H	●	42	5	29	M16	43	17	6									
new AEMR-RD1204-D25-M12-L35-Z02-H	●	25	2	21	M12	35	12.5	6	RD.. 1204	4015-M3.5x9	80-T15						
AEMR-RD1204-D32-M16-L43-Z03-H	●	32	3	29	M16	43	17	6									
new AEMR-RD1204-D40-M16-L43-Z04-H	●	40	4	29	M16	43	17	6									
AEMR-RD1204-D42-M16-L43-Z04-H	●	42	4	29	M16	43	17	6									
AEMR-RD1604-D32-M16-L43-Z02-H	●	32	2	29	M16	43	17	8				RD.. 1604	4015-M4.5x11	80-T15			
AEMR-RD1604-D40-M16-L43-Z02-H	●	40	2	29	M16	43	17	8									
AEMR-RD1604-D42-M16-L43-Z03-H	●	42	3	29	M16	43	17	8									

R: Sağ / Right / Правый L: Sol / Left / Левый

● Stokta / In Stock / В наличии ○ Stokta Yok / Non Stock Item / Нет в наличии
ISO Ucuna Uygunudur. / Compatible with ISO Insert. / Под пластину ISO.

Sipariş Örneği/Ordering Example/Образец заказа

1 ad./pcs./шт. AEMR-RD0702-D15-M08-L23-Z02-H

Kesme Hesabı : S 377 / Cutting Calculation : P 377 / Расчет режимов резания: стр. 377

Sıkma Tork Değeri : S 376 / Tightening Torque : P 376 / Момент затяжки: стр. 376

S-SİSTEM MODÜLER PARMAK FREZELER
S-SYSTEM MODULAR END MILLS (SCREW TYPE TOOLS)
С-ТИП СМЕННЫЕ ФРЕЗЕРНЫЕ ГОЛОВКИ (КРЕПЛЕНИЕ ПОД РЕЗЬБУ)

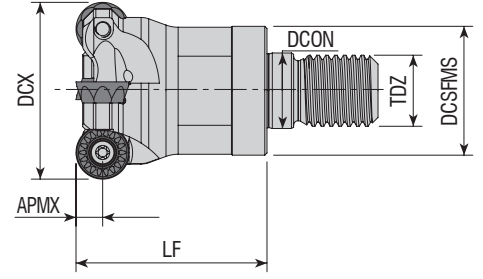

Takım Kodu Ordering Code Код для заказа	Stok Stock Наличие	Takım Ölçüleri (mm) Dimension (mm) Размеры (мм)							Kesici Uç Insert Пластина	Yedek Parçaları / Spare Parts / Запасные части		
		DCX	ZEFP	DCSFMS	TDZ	LF	DCON	APMX		Sikma Vidası Screw Зажимной винт	Tork Anahtar Torx Key Торх Ключ	
AEMR-RP10T3A-D32-M16-L43-Z04-H	●	32	4	29	M16	43	17	5	RPMW 10T3..		4015-M3.5x9	80-T15
AEMR-RP10T3A-D42-M16-L43-Z05-H	●	42	5	29	M16	43	17	5				

АЧТК Ucuna Uygundur. / Compatible with АЧТК Insert. / Под пластину АЧТК.

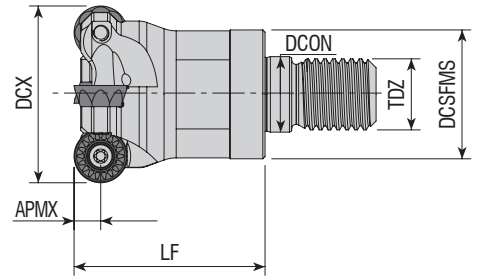

Takım Kodu Ordering Code Код для заказа	Stok Stock Наличие	Takım Ölçüleri (mm) Dimension (mm) Размеры (мм)							Kesici Uç Insert Пластина	Yedek Parçaları / Spare Parts / Запасные части		
		DCX	ZEFP	DCSFMS	TDZ	LF	DCON	APMX		Sikma Vidası Screw Зажимной винт	Tork Anahtar Torx Key Торх Ключ	
AEMR-RP10T3K-D32-M16-L43-Z04-H	●	32	4	29	M16	43	17	5	RPMT 10T3..		4010-M3x8	82-T10
AEMR-RP10T3K-D42-M16-L43-Z05-H	●	42	5	29	M16	43	17	5				

R: Sağ / Right / Правый L: Sol / Left / Левый

● Stokta / In Stock / В наличии ○ Stokta Yok / Non Stock Item / Нет в наличии

KYCR Ucuna Uygundur. / Compatible with KYCR Insert. / Под пластину KYCR.

Sipariş Örneği/Ordering Example/Образец заказа



1 ad./pcs./шт. AEMR-RP10T3A-D32-M16-L43-Z04-H

Kesme Hesabı : S 377/ Cutting Calculation : P 377 / Расчет режимов резания: стр. 377



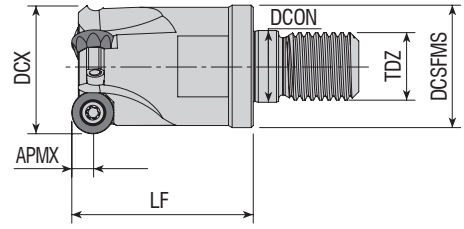



www.akkо.com.tr

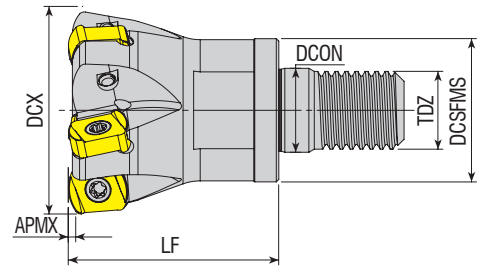

Takım Kodu Ordering Code Код для заказа	Stok Stock Наличие	Takım Ölçüleri (mm) Dimension (mm) Размеры (мм)							Kesici Uç Insert Пластина	Yedek Parçaları / Spare Parts / Запасные части		
		DCX	ZEFP	DCSFMS	TDZ	LF	DCON	APMX		Sıkma Vidası Screw Зажимной винт	Tork Anahtar Torx Key Торх Ключ	
AEMR-QP10T3-D25-M12-L35-Z02-H	●	25	2	21	M12	35	12.5	5				
AEMR-QP10T3-D32-M16-L43-Z03-H	●	32	3	29	M16	43	17	5				QP. 10T3..

SMTM Ucuna Uygun. / Compatible with SMTM Insert. / Под пластину SMTM.

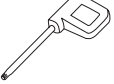

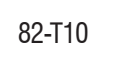
Takım Kodu Ordering Code Код для заказа	Stok Stock Наличие	Takım Ölçüleri (mm) Dimension (mm) Размеры (мм)							Kesici Uç Insert Пластина	Yedek Parçaları / Spare Parts / Запасные части		
		DCX	ZEFP	DCSFMS	TDZ	LF	DCON	APMX		Sıkma Vidası Screw Зажимной винт	Tork Anahtar Torx Key Торх Ключ	
AHFM-BL0603-D20-M10-L30-Z03-H	●	20	3	18	M10	30	10.5	1				
new AHFM-BL0603-D25-M12-L35-Z04-H	●	25	4	21	M12	35	12.5	1				BLMP 0603..
AHFM-BL0603-D32-M16-L40-Z05-H	●	32	5	29	M16	40	17	1	BLMP 0904..			
AHFM-BL0904-D32-M16-L40-Z04-H	●	32	4	29	M16	40	17	1.5				
AHFM-BL0904-D32-M16-L43-Z04-H	●	32	4	29	M16	43	17	1.5				
AHFM-BL0904-D42-M16-L43-Z05-H	●	42	5	29	M16	43	17	1.5				

R: Sağ / Right / Правый L: Sol / Left / Левый

● Stokta / In Stock / В наличии ○ Stokta Yok / Non Stock Item / Нет в наличии

TGTC Ucuna Uygun. / Compatible with TGTC Insert. / Под пластину TGTC.

Sipariş Örneği/Ordering Example/Образец заказа

1 ad./pcs./шт. AEMR-QP10T3-D25-M12-L35-Z02-H

Kesme Hesabı : S 377 / Cutting Calculation : P 377 / Расчет режимов резания: стр. 377

Sıkma Tork Değeri : S 376 / Tightening Torque : P 376 / Момент затяжки: стр. 376

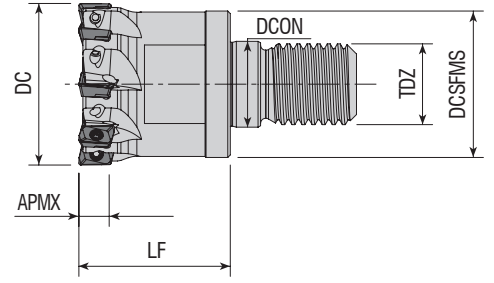

Takım Kodu Ordering Code Код для заказа	Stok Stock Наличие	Takım Ölçüleri (mm) Dimension (mm) Размеры (мм)							Kesici Uç Insert Пластина	Yedek Parçaları / Spare Parts / Запасные части	
		DC	ZEFP	DCSFMS	TDZ	LF	DCON	APMX		Sıkma Vidası Screw Зажимной винт	Tork Anahtar Torx Key Торх Ключ
AHFM-ED0702-D12-M06-L20-Z03	●	12	3	10	M06	20	6.5	6	EDMT 0702 JDMT 070204	3006-M1.8x4	82-T06
AHFM-ED0702-D16-M08-L25-Z04-H	●	16	4	14.75	M08	25	8.5	6			
AHFM-ED0702-D20-M10-L30-Z05-H	●	20	5	18	M10	30	10.5	6			
AHFM-ED0702-D25-M12-L30-Z06-H	●	25	6	21	M12	30	12.5	6			
AHFM-ED0702-D32-M16-L30-Z08-H	●	32	8	29	M16	30	17	6			

HTCH Ucuna Uygundur. / Compatible with HTCH Insert. / Под пластину HTCH

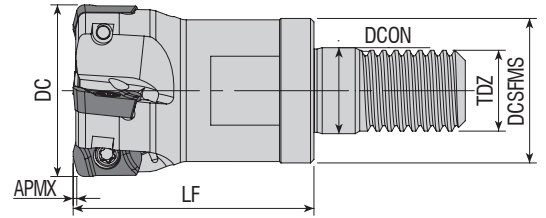
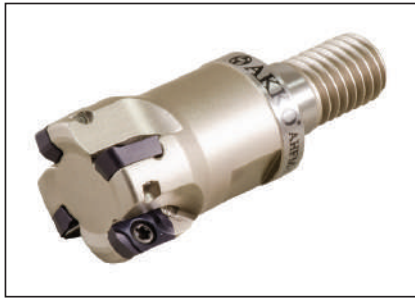

Takım Kodu Ordering Code Код для заказа	Stok Stock Наличие	Takım Ölçüleri (mm) Dimension (mm) Размеры (мм)							Kesici Uç Insert Пластина	Yedek Parçaları / Spare Parts / Запасные части	
		DC	ZEFP	DCSFMS	TDZ	LF	DCON	APMX		Sıkma Vidası Screw Зажимной винт	Tork Anahtar Torx Key Торх Ключ
new AHFM-EP1003-D16-M08-L23-Z02	●	16	2	14.75	M08	23	8.5	1	EP. 1003.. ZPMT 1003.. YPHW 1003..	3008-M2.5x5	82-T08
AHFM-EP1003-D16-M08-L23-Z02-H	●	16	2	14.75	M08	23	8.5	1			
new AHFM-EP1003-D20-M10-L30-Z03	●	20	3	18	M10	30	10.5	1			
AHFM-EP1003-D20-M10-L30-Z04-H	●	20	4	18	M10	30	10.5	1			
AHFM-EP1003-D25-M12-L35-Z04-H	●	25	4	21	M12	35	12.5	1			
AHFM-EP1003-D32-M16-L43-Z05-H	●	32	5	29	M16	43	17	1			
AHFM-EP1003-D35-M16-L43-Z05-H	●	35	5	29	M16	43	17	1			
AHFM-EP1003-D42-M16-L43-Z06-H	●	42	6	29	M16	43	17	1			

R: Sağ / Right / Правый L: Sol / Left / Левый

● Stokta / In Stock / В наличии ○ Stokta Yok / Non Stock Item / Нет в наличии

DJT Ucuna Uygundur. / Compatible with DJT Insert. / Под пластину DJT

Sipariş Örneği/Ordering Example/Образец заказа

1 ad./pcs./шт. AHFM-ED0702-D12-M06-L20-Z03

Kesme Hesabı : S 377 / Cutting Calculation : P 377 / Расчет режимов резания: стр. 377

Sıkma Tork Değeri : S 376 / Tightening Torque : P 376 / Момент затяжки: стр. 376

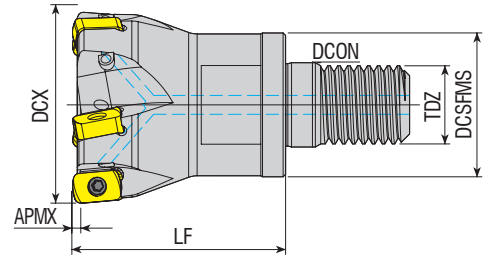

Takım Kodu Ordering Code Код для заказа	Stok Stock Наличие	Takım Ölçüleri (mm) Dimension (mm) Размеры (мм)						Kesici Uç Insert Пластина	Yedek Parçaları / Spare Parts / Запасные части				
		DCX	ZEFP	DCSFMS	TDZ	LF	DCON		APMX	Sıkma Vidası Screw Зажимной винт	Baskı Parçası Wedge Clamp Прижим	Baskı Vidası Clamp Screw Зажимной винт	Tork Anahtar Torx Key Торх Ключ
AHFM-EN1004-D16-M08-L23-Z02-H	●	16	2	14.75	M08	23	8.5	1	ENMU 1004..	3008-M2.5x5			82-T08
AHFM-EN1004-D20-M10-L30-Z03-H	●	20	3	18	M10	30	10.5	1					
AHFM-EN1004-D25-M12-L35-Z03-H	●	25	3	21	M12	35	12.5	1					
AHFM-EN1004-D25-M12-L35-Z04-H	●	25	4	21	M12	35	12.5	1					
AHFM-EN1004-D32-M16-L43-Z05-H	●	32	5	29	M16	43	17	1					
AHFM-EN1004-D35-M16-L43-Z05-H	●	35	5	29	M16	43	17	1					
AHFM-EN1004-D40-M16-L43-Z05-H	●	40	5	29	M16	43	17	1					
AHFM-EN1004-D42-M16-L43-Z05-H	●	42	5	29	M16	43	17	1					

DJT Ucuna Uygunudur. / Compatible with DJT Insert. / Под пластину DJT

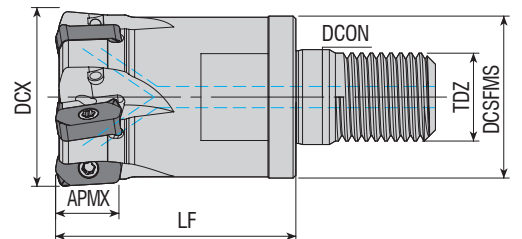

Takım Kodu Ordering Code Код для заказа	Stok Stock Наличие	Takım Ölçüleri (mm) Dimension (mm) Размеры (мм)						Kesici Uç Insert Пластина	Yedek Parçaları / Spare Parts / Запасные части				
		DCX	ZEFP	DCSFMS	TDZ	LF	DCON		APMX	Sıkma Vidası Screw Зажимной винт	Baskı Parçası Wedge Clamp Прижим	Baskı Vidası Clamp Screw Зажимной винт	Tork Anahtar Torx Key Торх Ключ
AHFM-LN0303-D25-M12-L35-Z04-H	●	25	4	21	M12	35	12.5	12	LNMU 0303..	3008-M2.5x6	-	-	82-T08
AHFM-LN0303-D32-M16-L43-Z05-H	●	32	5	29	M16	43	17	12					
AHFM-LN0303-D42-M16-L43-Z06-H	●	42	6	29	M16	43	17	12					

R: Sağ / Right / Правый L: Sol / Left / Левый

● Stokta / In Stock / В наличии ○ Stokta Yok / Non Stock Item / Нет в наличии

TNGLY Ucuna Uygunudur. / Compatible with TNGLY Insert. / Под пластину TNGLY

Sipariş Örneği/Ordering Example/Образец заказа

1 ad./pcs./шт. AHFM-EN1004-D16-M08-L23-Z02-H

Kesme Hesabı : S 377 / Cutting Calculation : P 377 / Расчет режимов резания: стр. 377

Sıkma Tork Değeri : S 376 / Tightening Torque : P 376 / Момент затяжки: стр. 376

➤ **S-SİSTEM HIZLI İLERLEMELİ MODÜLER PARMAK FREZELER**
S-SYSTEM MODULAR (SCREW TYPE) HIGHFEED END MILLS
С-ТИП ВЫСОКОПРОИЗВОДИТЕЛЬНЫЕ СМЕННЫЕ ФРЕЗЕРНЫЕ ГОЛОВКИ

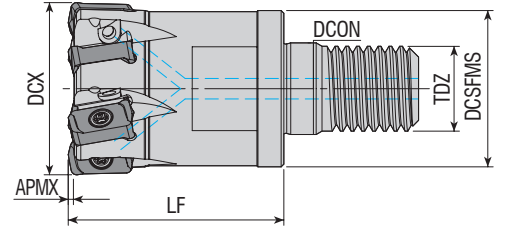

Takım Kodu Ordering Code Код для заказа	Stok Stock Наличие	Takım Ölçüleri (mm) Dimension (mm) Размеры (мм)						Kesici Uç Insert Пластина	Yedek Parçaları / Spare Parts / Запасные части				
		DCX	ZEPF	DCSFMS	TDZ	LF	DCON		APMX	Sıkma Vidası Screw Зажимной винт	Baskı Parçası Wedge Clamp Прижим	Baskı Vidası Clamp Screw Зажимной винт	Tork Anahtar Torx Key Торх Ключ
AHFM-L003-D20-M10-L30-Z04-H-F	●	20	4	18	M10	30	10.5	1	LOGU 0303..	1108-M3x6.8	-	-	82-T08
AHFM-L003-D25-M12-L35-Z04-H-F	●	25	4	21	M12	35	12.5	1					
AHFM-L003-D25-M12-L35-Z04-H	●	25	4	21	M12	35	12.5	1					
AHFM-L003-D32-M16-L40-Z05-H-F	●	32	5	29	M16	40	17	1					
AHFM-L003-D32-M16-L40-Z05-H	●	32	5	29	M16	40	17	1					
AHFM-L003-D32-M16-L40-Z06-H-F	●	32	6	29	M16	40	17	1					
AHFM-L003-D32-M16-L40-Z06-H	●	32	6	29	M16	40	17	1					
AHFM-L003-D35-M16-L40-Z05-H	●	35	5	29	M16	40	17	1					
AHFM-L003-D35-M16-L40-Z06-H	●	35	6	29	M16	40	17	1					
AHFM-L003-D42-M16-L40-Z05-H	●	42	5	29	M16	40	17	1					
AHFM-L003-D42-M16-L40-Z06-H	●	42	6	29	M16	40	17	1					

R: Sağ / Right / Правый L: Sol / Left / Левый

● Stokta / In Stock / В наличии ○ Stokta Yok / Non Stock Item / Нет в наличии

KYCR Ucuna Uygunur. / Compatible with KYCR Insert. / Под пластину KYCR

F: Eksenel ve Radyal Salgı Değeri 0,02 mm içindedir. / F: Axial and Radial Runout Value is within 0,02 mm.

F: значение радиального и осевого биения в пределах 0,02 мм.

Kesme Hesabı : S 367 / Cutting Calculation : P 367 / Расчет режимов резания: стр. 367

Sıkma Tork Değeri : S 367 / Tightening Torque : P 367 / Момент затяжки: стр. 367

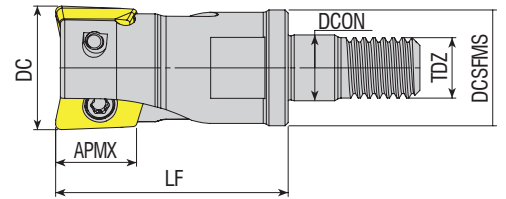

Takım Kodu Ordering Code Код для заказа	Stok Stock Наличие	Takım Ölçüleri (mm) Dimension (mm) Размеры (мм)						Kesici Uç Insert Пластина	Yedek Parçaları / Spare Parts / Запасные части		
		DC	ZEPF	DCSFMS	TDZ	LF	DCON		APMX	Sıkma Vidası Screw Зажимной винт	Tork Anahtar Torx Key Торх Ключ
AHFM-JD1003-D16-M08-L30-Z02-H	●	16	2	14.75	M08	30	8.5	9	JDMT 1003..	3008-M2.5x6	82-T08
AHFM-JD1003-D20-M10-L30-Z03-H	●	20	3	18	M10	30	10.5	9			

HTCH Ucuna Uygunur. / Compatible with HTCH Insert. / Под пластину HTCH

Sipariş Örneği/Ordering Example/Образец заказа
1 ad./pcs./шт. AHFM-L003-D20-M10-L30-Z04-H-F

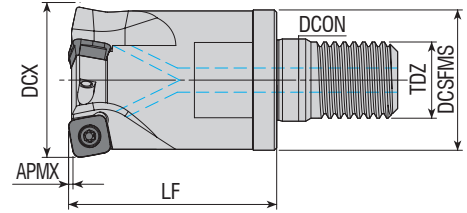

Takım Kodu Ordering Code Код для заказа	Stok Stock Наличие	Takım Ölçüleri (mm) Dimension (mm) Размеры (мм)							Kesici Uç Insert Пластина	Yedek Parçaları / Spare Parts / Запасные части		
		DCX	ZEFP	DCSFMS	TDZ	LF	DCON	APMX		Sıkma Vidası Screw Зажимной винт	Tork Anahtar Torx Key Торх Ключ	
AHFM-SD1205-D32-M16-L40-Z03-H	●	32	3	29	M16	40	17	2				
AHFM-SD1205-D35-M16-L40-Z03-H	●	35	3	29	M16	40	17	2				
AHFM-SD1205-D40-M16-L43-Z03-H	●	40	3	29	M16	43	17	2				
AHFM-SD1205-D42-M16-L43-Z03-H	●	42	3	29	M16	43	17	2				

HTCH Ucuna Uygundur. / Compatible with HTCH Insert. / Под пластину HTCH.

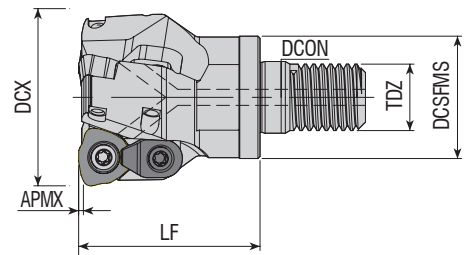

Takım Kodu Ordering Code Код для заказа	Stok Stock Наличие	Takım Ölçüleri (mm) Dimension (mm) Размеры (мм)							Kesici Uç Insert Пластина	Yedek Parçaları / Spare Parts / Запасные части			
		DCX	ZEFP	DCSFMS	TDZ	LF	DCON	APMX		Sıkma Vidası Screw Зажимной винт	Baskı Parçası Wedge Clamp Прижим	Baskı Vidası Clamp Screw Зажимной винт	Tork Anahtar Torx Key Торх Ключ
AHFMC-JD1204-D32-M16-L43-Z02-H	●	32	2	29	M16	43	17	1.5					
AHFMC-JD1204-D42-M16-L43-Z03-H	●	42	3	29	M16	43	17	1.5					

R: Sağ / Right / Правый L: Sol / Left / Левый

● Stokta / In Stock / В наличии ○ Stokta Yok / Non Stock Item / Нет в наличии

MTSBH Ucuna Uygundur. / Compatible with MTSBH Insert. / Под пластину MTSBH

Sipariş Örneği/Ordering Example/Образец заказа
1 ad./pcs./шт. AHFM-SD1205-D32-M16-L40-Z03-H

➤ **S-SİSTEM HIZLI İLERLEMELİ MODÜLER PARMAK FREZELER**
S-SYSTEM MODULAR (SCREW TYPE) HIGHFEED END MILLS
С-ТИП ВЫСОКОПРОИЗВОДИТЕЛЬНЫЕ СМЕННЫЕ ФРЕЗЕРНЫЕ ГОЛОВКИ

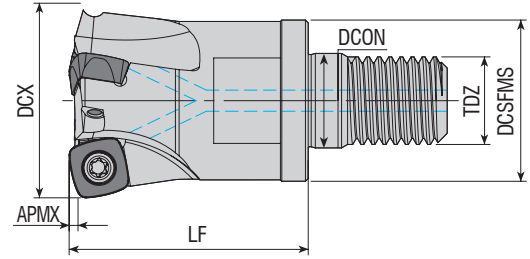

Takım Kodu Ordering Code Код для заказа	Stok Stock Наличие	Takım Ölçüleri (mm) Dimension (mm) Размеры (мм)							Kesici Uç Insert Пластина	Yedek Parçaları / Spare Parts / Запасные части	
		DCX	ZEFP	DC SFMS	TDZ	LF	DCON	APMX		Sıkma Vidası Screw Зажимной винт	Tork Anahtar Torx Key Торх Ключ
AHFM-SP0735-D16-M08-L23-Z02-H	●	16	2	14.75	M08	23	8.5	1.2	SPMX 073505		
AHFM-SP0735-D20-M10-L30-Z03-H	●	20	3	18	M10	30	10.5	1.2			
AHFM-SP0735-D25-M12-L35-Z04-H	●	25	4	21	M12	35	12.5	1.2			

MTSBH Ucuna Uygunur. / Compatible with MTSBH Insert. / Под пластину MTSBH.

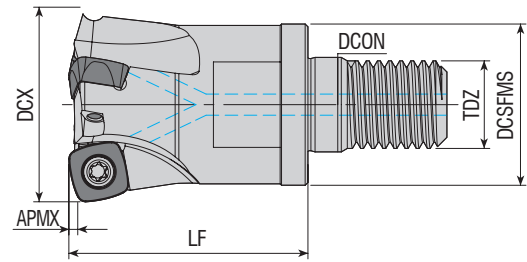

Takım Kodu Ordering Code Код для заказа	Stok Stock Наличие	Takım Ölçüleri (mm) Dimension (mm) Размеры (мм)							Kesici Uç Insert Пластина	Yedek Parçaları / Spare Parts / Запасные части	
		DCX	ZEFP	DC SFMS	TDZ	LF	DCON	APMX		Sıkma Vidası Screw Зажимной винт	Tork Anahtar Torx Key Торх Ключ
AHFM-SP0945-D32-M16-L43-Z04-H	●	32	4	29	M16	43	17	1.4	SPMX 094506		
AHFM-SP0945-D35-M16-L43-Z04-H	●	35	4	29	M16	43	17	1.4			
AHFM-SP0945-D42-M16-L43-Z05-H	●	42	5	29	M16	43	17	1.4			

R: Sağ / Right / Правый L: Sol / Left / Левый

● Stokta / In Stock / В наличии ○ Stokta Yok / Non Stock Item / Нет в наличии

MTSBH Ucuna Uygunur. / Compatible with MTSBH Insert. / Под пластину MTSBH.

Sipariş Örneği/Ordering Example/Образец заказа

1 ad./pcs./шт. AHFM-SP0735-D16-M08-L23-Z02-H

Kesme Hesabı : S 367 / Cutting Calculation : P 367 / Расчет режимов резания: стр. 367



www.akkо.com.tr

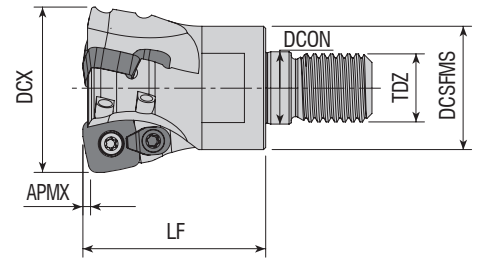

Takım Kodu Ordering Code Код для заказа	Stok Stock Наличие	Takım Ölçüleri (mm) Dimension (mm) Размеры (мм)						Kesici Uç Insert Пластина	Yedek Parçaları / Spare Parts / Запасные части				
		DCX	ZEFP	DCSFMS	TDZ	LF	DCON		APMX	Sıkma Vidası Screw Зажимной винт	Baskı Parçası Wedge Clamp Прижим	Baskı Vidası Clamp Screw Зажимной винт	Tork Anahtar Torx Key Торх Ключ
AHFM-SD06T2-D16-M08-L23-Z02-H	●	16	2	14.75	M08	23	8.5	0.8					
AHFM-SD06T2-D20-M10-L30-Z03-H	●	20	3	18	M10	30	10.5	0.8	SD.. 06T2..	3007-M2.2x4.6	-	-	82-T07
AHFM-SD06T2-D25-M12-L35-Z04-H	●	25	4	21	M12	35	12.5	0.8					
AHFMC-SD09T3-D25-M12-L30-Z02-H	●	25	2	22	M12	30	12.5	1.4	SD.. 09T3..	3010-M3.5x9	ACK-15	1510-M3.5x9	82-T10
AHFMC-SD09T3-D32-M16-L43-Z03-H	●	32	3	29	M16	43	17	1.4					
AHFMC-SD09T3-D35-M16-L43-Z03-H	●	35	3	29	M16	43	17	1.4					
AHFMC-SD09T3-D40-M16-L43-Z04-H	●	40	4	29	M16	43	17	1.4					
AHFMC-SD1204-D32-M16-L43-Z02-H	●	32	2	29	M16	43	17	1.8	SD.. 1204..	4015-M4x9		4015-M3.5X11	80-T15
AHFMC-SD1204-D40-M16-L43-Z03-H	●	40	3	29	M16	43	17	1.8					

ZCC Ucuna Uygunudur. / Compatible with ZCC Insert. / Под пластину ZCC

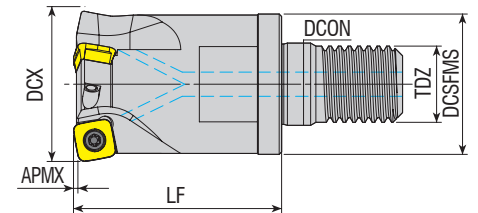

Takım Kodu Ordering Code Код для заказа	Stok Stock Наличие	Takım Ölçüleri (mm) Dimension (mm) Размеры (мм)						Kesici Uç Insert Пластина	Yedek Parçaları / Spare Parts / Запасные части				
		DCX	ZEFP	DCSFMS	TDZ	LF	DCON		APMX	Sıkma Vidası Screw Зажимной винт	Baskı Parçası Wedge Clamp Прижим	Baskı Vidası Clamp Screw Зажимной винт	Tork Anahtar Torx Key Торх Ключ
AHFM-SO0803-D20-M10-L30-Z02-H	●	20	2	18	M10	30	10.5	1	SOMW 0803..	4010-M3X8	-	-	82-T10
AHFM-SO0803-D25-M12-L35-Z03-H	●	25	3	22	M12	35	12.5	1					
AHFM-SO0803-D32-M16-L43-Z03-H	●	32	3	29	M16	43	17	1					
AHFM-SO0803-D32-M16-L43-Z04-H	●	32	4	29	M16	43	17	1					
AHFM-SO0803-D40-M16-L43-Z04-H	●	40	4	29	M16	43	17	1					

R: Sağ / Right / Правый L: Sol / Left / Левый
● Stokta / In Stock / В наличии ○ Stokta Yok / Non Stock Item / Нет в наличии
KPTK Ucuna Uygunudur. / Compatible with KPTK Insert. / Под пластину KPTK

Sipariş Örneği/Ordering Example/Образец заказа
1 ad./pcs./шт. AHFM-SD06T2-D16-M08-L23-Z02-H

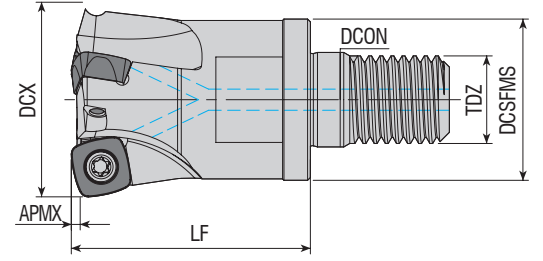

Takım Kodu Ordering Code Код для заказа	Stok Stock Наличие	Takım Ölçüleri (mm) Dimension (mm) Размеры (мм)							Kesici Uç Insert Пластина	Yedek Parçaları / Spare Parts / Запасные части		
		DCX	ZEPF	DC SFMS	TDZ	LF	DCON	APMX		Sıkma Vidası Screw Зажимной винт	Tork Anahtar Torx Key Торх Ключ	
AHFM-SO0803P-D32-M16-L35-Z04-H	●	32	4	29	M16	35	17	1	SOEW 0803	4010-M3x8	82-T10	
AHFM-SO0803P-D42-M16-L35-Z05-H	●	42	5	29	M16	35	17	1				

PLBT Ucuna Uygunur. / Compatible with PLBT Insert. / Под пластину PLBT.

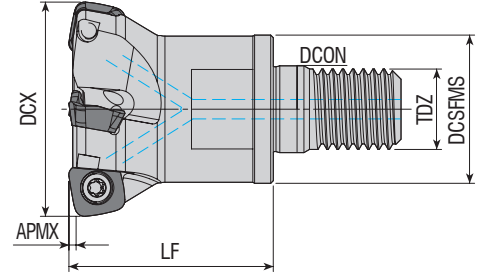

Takım Kodu Ordering Code Код для заказа	Stok Stock Наличие	Takım Ölçüleri (mm) Dimension (mm) Размеры (мм)							Kesici Uç Insert Пластина	Yedek Parçaları / Spare Parts / Запасные части			
		DCX	ZEPF	DCSFMS	TDZ	LF	DCON	APMX		Sıkma Vidası Screw Зажимной винт	Baskı Parçası Wedge Clamp Прижим	Baskı Vidası Clamp Screw Зажимной винт	Tork Anahtar Torx Key Торх Ключ
AHFM-SO1004-D32-M16-L40-Z03-H	●	32	3	29	M16	40	17	1.5	SOMT 1004..	4015-M4x9	-	-	80-T15
AHFM-SO1004-D40-M16-L40-Z04-H	●	40	4	29	M16	40	17	1.5					
AHFM-SO1004-D42-M16-L40-Z04-H	●	42	4	29	M16	40	17	1.5					

KYCR Ucuna Uygunur. / Compatible with KYCR Insert. / Под пластину KYCR

Sipariş Örneği/Ordering Example/Образец заказа

1 ad./pcs./шт. AHFM-SO0803P-D32-M16-L35-Z04-H

Kesme Hesabı : S 377/ Cutting Calculation : P 377 / Расчет режимов резания: стр. 377

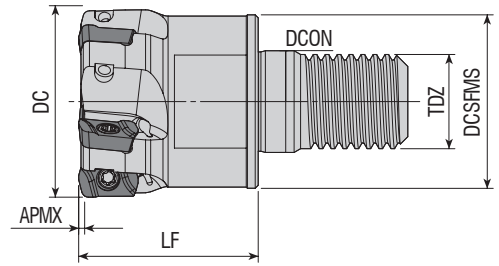

Takım Kodu Ordering Code Код для заказа	Stok Stock Наличие	Takım Ölçüleri (mm) Dimension (mm) Размеры (мм)							Kesici Uç Insert Пластина	Yedek Parçaları / Spare Parts / Залпасные части				
		DC	ZEFP	DCSFMS	TDZ	LF	DCON	APMX		Sıkma Vidası Screw Зажимной винт	Baskı Parçası Wedge Clamp Прижим	Baskı Vidası Clamp Screw Зажимной винт	Tork Anahtar Torx Key Торх Ключ	
AHFM-YP1003-D16-M08-L23-Z02-F	●	16	2	14.75	M08	23	8.5	1	EP. 1003.. ZPMT 1003.. YPHW 1003..	3008-M2.5x5	-	-	82-T08	
AHFM-YP1003-D16-M08-L23-Z02-H-F	●	16	2	14.75	M08	23	8.5	1						
AHFM-YP1003-D17-M08-L23-Z02-H	●	17	2	14.75	M08	23	8.5	1						
AHFM-YP1003-D17-M08-L23-Z02-H-F	●	17	2	14.75	M08	23	8.5	1						
AHFM-YP1003-D20-M10-L30-Z03-H	●	20	3	18	M10	30	10.5	1						
AHFM-YP1003-D20-M10-L30-Z03-H-F	●	20	3	18	M10	30	10.5	1						
AHFM-YP1003-D20-M10-L30-Z04-H	●	20	4	18	M10	30	10.5	1						
AHFM-YP1003-D20-M10-L30-Z04-F	●	20	4	18	M10	30	10.5	1						
AHFM-YP1003-D21-M10-L30-Z03-H	●	21	3	18	M10	30	10.5	1						
AHFM-YP1003-D21-M10-L30-Z03-H-F	●	21	3	18	M10	30	10.5	1						
AHFM-YP1003-D25-M12-L35-Z04-H	●	25	4	21	M12	35	12.5	1						
AHFM-YP1003-D25-M12-L35-Z04-F	●	25	4	21	M12	35	12.5	1						
AHFM-YP1003-D25-M12-L35-Z04-H-F	●	25	4	21	M12	35	12.5	1						
AHFM-YP1003-D26-M12-L35-Z04-H-F	●	26	4	21	M12	35	12.5	1						
AHFM-YP1003-D32-M16-L30-Z05-F	●	32	5	29	M16	30	17	1						
AHFM-YP1003-D32-M16-L43-Z05-H-F	●	32	5	29	M16	43	17	1						
AHFM-YP1003-D40-M16-L43-Z06-H-F	●	40	6	29	M16	43	17	1						
AHFM-YP1003-D42-M16-L43-Z06-H-F	●	42	6	29	M16	43	17	1						
											3008-M2.5x6			

R: Sağ / Right / Правый L: Sol / Left / Левый

● Stokta / In Stock / В наличии ○ Stokta Yok / Non Stock Item / Нет в наличии

DJT Ucuna Uygunudur. / Compatible with DJT Insert. / Под пластину DJT

Çap Ölçüsü - 0,02 mm Olarak üretiliyor. F: ± 0,02 mm Demektir. Ör: Ø16 Takım 15,98 ± 0,02 mm yani 16,00 mm - 15,96 mm Olmalıdır.

Diameter Size is produced as - 0.02 mm. F: means ± 0,02 mm. For example: Ø16 tool 15,98 ± 0,02 mm, it means that it should be 16,00 mm - 15,96 mm.

Размер диаметра составляет -0,02 мм. F: означает ± 0,02 мм. Например: Ø16 инструмент 15,98 ± 0,02 мм, должно быть 16,00мм -15,96 мм.

Sipariş Örneği/Ordering Example/Образец заказа

1 ad./pcs./шт. AHFM-YP1003-D16-M08-L23-Z02-F

Kesme Hesabı : S 377 / Cutting Calculation : P 377 / Расчет режимов резания: стр. 377

Sıkma Tork Değeri : S 376 / Tightening Torque : P 376 / Момент затяжки: стр. 376

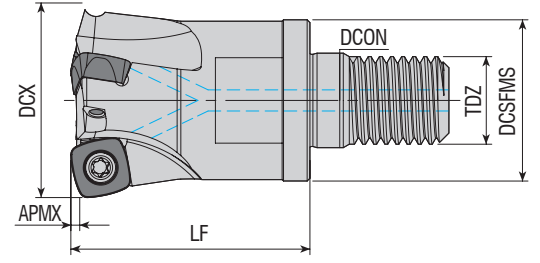

Takım Kodu Ordering Code Код для заказа	Stok Stock Наличие	Takım Ölçüleri (mm) Dimension (mm) Размеры (мм)							Kesici Uç Insert Пластина	Yedek Parçaları / Spare Parts / Запасные части			
		DCX	ZEFP	DCSFMS	TDZ	LF	DCON	APMX		Sıkma Vidası Screw Зажимной винт	Baskı Parçası Wedge Clamp Прижим	Baskı Vidası Clamp Screw Зажимной винт	Tork Anahtar Torx Key Торх Ключ
AHFM-SP1004-D25-M12-L35-Z02-H	●	25	2	21	M12	35	12.5	1	SPNW 1004..		-	-	80-T15
AHFM-SP1004-D32-M16-L43-Z03-H	●	32	3	29	M16	43	17	1.5					
AHFM-SP1004-D35-M16-L43-Z03-H	●	35	3	29	M16	43	17	1.5					
AHFM-SP1004-D42-M16-L43-Z04-H	●	42	4	29	M16	43	17	1.5					

DJT Ucuna Uygunur. / Compatible with DJT Insert. / Под пластину DJT

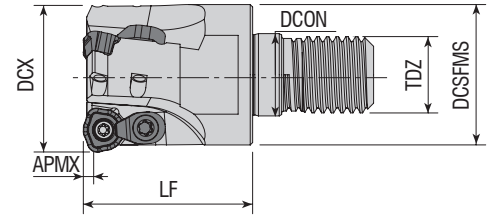

Takım Kodu Ordering Code Код для заказа	Stok Stock Наличие	Takım Ölçüleri (mm) Dimension (mm) Размеры (мм)							Kesici Uç Insert Пластина	Yedek Parçaları / Spare Parts / Запасные части			
		DCX	ZEFP	DCSFMS	TDZ	LF	DCON	APMX		Sıkma Vidası Screw Зажимной винт	Baskı Parçası Wedge Clamp Прижим	Baskı Vidası Clamp Screw Зажимной винт	Tork Anahtar Torx Key Торх Ключ
AHFMC-WD0804-D25-M12-L35-Z02-H	●	25	2	21	M12	35	12.5	1.5	WDMT 0804..		ACK-15	4010-M3x8	82-T10
AHFMC-WD0804-D32-M16-L35-Z03-H	●	32	3	29	M16	35	17	1.5					

R: Sağ / Right / Правый L: Sol / Left / Левый

● Stokta / In Stock / В наличии ○ Stokta Yok / Non Stock Item / Нет в наличии

SMTM Ucuna Uygunur. / Compatible with SMTM Insert. / Под пластину SMTM.

Sipariş Örneği/Ordering Example/Образец заказа

1 ad./pcs./шт. AHFM-SP1004-D25-M12-L35-Z02-H

Kesme Hesabı : S 377 / Cutting Calculation : P 377 / Расчет режимов резания: стр. 377

Sıkma Tork Değeri : S 376 / Tightening Torque : P 376 / Момент затяжки: стр. 376

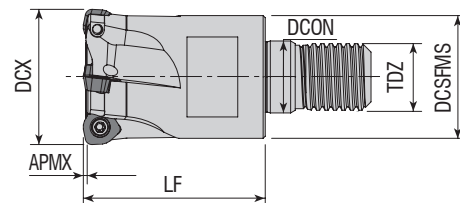

Takım Kodu Ordering Code Код для заказа	Stok Stock Наличие	Takım Ölçüleri (mm) Dimension (mm) Размеры (мм)							Kesici Uç Insert Пластина	Yedek Parçaları / Spare Parts / Запасные части			
		DCX	ZEFP	DCSFMS	TDZ	LF	DCON	APMX		Sıkma Vidası Screw Зажимной винт	Baskı Parçası Wedge Clamp Прижим	Baskı Vidası Clamp Screw Зажимной винт	Tork Anahtar Torx Key Торх Ключ
AHFM-WD0503D-D20-M10-L30-Z02-H	●	20	2	18	M10	30	10.5	1.25	WDMT 0503..	4010-M3x6	-	-	82-T10
AHFM-WD0503D-D25-M12-L35-Z03-H	●	25	3	21	M12	35	12.5	1.25		4010-M3x8	-	-	
AHFM-WD0503D-D32-M16-L43-Z04-H	●	32	4	29	M16	43	17	1.25		-	-	-	
AHFM-WD0503D-D40-M16-L43-Z05-H	●	40	5	29	M16	43	17	1.25		-	-	-	
AHFMC-WD06T3D-D35-M16-L43-Z03-H	●	35	3	29	M16	43	17	1.5	WDHW 06T3..	3015-M3.5x9	ACK-15	4015-M3.5x11	80-T15
AHFMC-WD0805D-D32-M16-L43-Z02-H	●	32	2	29	M16	43	17	2	WDHW 0805..	4020-M4.5x10	ACK-19	4020-M4.5x12	

DJT Ucuna Uygunudur. / Compatible with DJT Insert. / Под пластину DJT

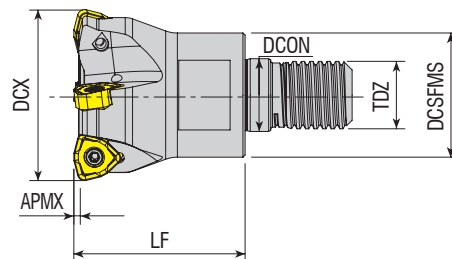

Takım Kodu Ordering Code Код для заказа	Stok Stock Наличие	Takım Ölçüleri (mm) Dimension (mm) Размеры (мм)							Kesici Uç Insert Пластина	Yedek Parçaları / Spare Parts / Запасные части		
		DCX	ZEFP	DCSFMS	TDZ	LF	DCON	APMX		Sıkma Vidası Screw Зажимной винт	Tork Anahtar Torx Key Торх Ключ	
AHFM-WN09T3-D32-M16-L40-Z03-H	●	32	3	29	M16	40	17	1.5	WNMX 09T3..	4010-M3x8	82-T10	
new AHFM-WN09T3-D35-M16-L40-Z04-H	●	35	4	26	M16	40	17	1.5				
AHFM-WN09T3-D40-M16-L40-Z04-H	●	40	4	29	M16	40	17	1.5				

R: Sağ / Right / Правый L: Sol / Left / Левый

● Stokta / In Stock / В наличии ○ Stokta Yok / Non Stock Item / Нет в наличии

KRLY Ucuna Uygunudur. / Compatible with KRLY Insert. / Под пластину KRLY

Sipariş Örneği/Ordering Example/Образец заказа

1 ad./pcs./шт. AHFM-WD0503D-D20-M10-L30-Z02-H

Kesme Hesabı : S 377 / Cutting Calculation : P 377 / Расчет режимов резания: стр. 377

Sıkma Tork Değeri : S 376 / Tightening Torque : P 376 / Момент затяжки: стр. 376

➤ KÜRE UÇLU PARMAK FREZELER
BALL NOSE END MILLS
СФЕРИЧЕСКИЕ КОНЦЕВЫЕ ФРЕЗЫ

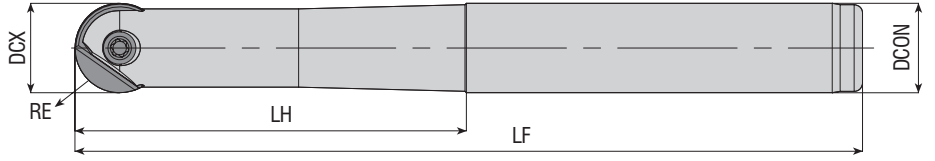

Takım Kodu Ordering Code Код для заказа	Stok Stock Наличие	Takım Ölçüleri (mm) Dimension (mm) Размеры (мм)					Kesici Uç Insert Пластина	Yedek Parçaları / Spare Parts / Запасные части	
		DCX	RE	DCON	LF	LH		Sıkma Vidası Screw Зажимной винт	Tork Anahtar Torx Key Торк Ключ
APMR-BNM12-D12-C12-L130	●	12	6	12	130	32			
APMR-BNM16-D16-C16-L175	●	16	8	16	175	70			
APMR-BNM16-D16-C16-L200	●	16	8	16	200	100			
APMR-BNM20-D20-C20-L160	●	20	10	20	160	70			
APMR-BNM20-D20-C20-L200	●	20	10	20	200	100			
APMR-BNM20-D20-C20-L250	●	20	10	20	250	150			
APMR-BNM25-D25-C25-L160	●	25	12.5	25	160	70			
APMR-BNM25-D25-C25-L200	●	25	12.5	25	200	100			
APMR-BNM25-D25-C25-L250	●	25	12.5	25	250	150			

DJT Ucuna Uygun dur. / Compatible with DJT Insert. / Под пластину DJT

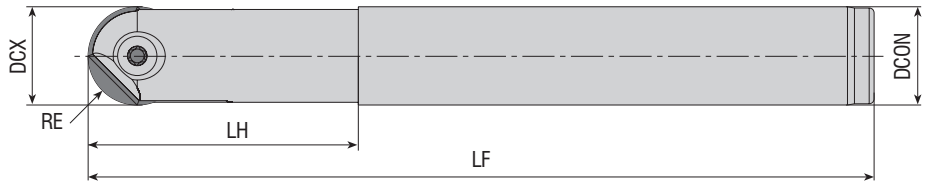

Takım Kodu Ordering Code Код для заказа	Stok Stock Наличие	Takım Ölçüleri (mm) Dimension (mm) Размеры (мм)					Kesici Uç Insert Пластина	Yedek Parçaları / Spare Parts / Запасные части	
		DCX	RE	DCON	LF	LH		Sıkma Vidası Screw Зажимной винт	Tork Anahtar Torx Key Торк Ключ
APMR-RO12-D12-C12-L120	●	12	6	12	120	35			
APMR-RO12-D12-C16-L160	●	12	6	16	160	50			
APMR-RO16-D16-C16-L160	●	16	8	16	160	45			
APMR-RO16-D16-C16-L200	●	16	8	16	200	45			
APMR-RO16-D16-C20-L200	●	16	8	20	200	65			
APMR-RO20-D20-C20-L160	●	20	10	20	160	55			
APMR-RO20-D20-C20-L200	●	20	10	20	200	55			
APMR-RO20-D20-C25-L220	●	20	10	25	220	80			

R: Sağ / Right / Правый L: Sol / Left / Левый

● Stokta / In Stock / В наличии ○ Stokta Yok / Non Stock Item / Нет в наличии

ZCC Ucuna Uygun dur. / Compatible with ZCC Insert. / Под пластину ZCC

Sipariş Örneği/Ordering Example/Образец заказа

1 ad./pcs./шт. APMR-BNM12-D12-C12-L130

Kesme Hesabı : S 377/ Cutting Calculation : P 377 / Расчет режимов резания: стр. 377

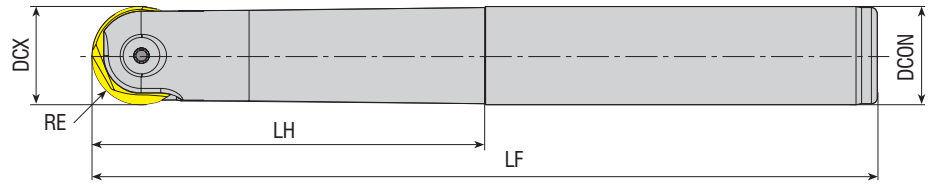

Takım Kodu Ordering Code Код для заказа	Stok Stock Наличие	Takım Ölçüleri (mm) Dimension (mm) Размеры (мм)					Kesici Uç Insert Пластина	Yedek Parçaları / Spare Parts / Запасные части	
		DCX	RE	DCON	LF	LH		Sıkma Vidası Screw Зажимной винт	Tork Anahtar Torx Key Торх Ключ
APMR-P3208-D08-C10-L110	●	8	4	10	110	25			
APMR-P3210-D10-C10-L130	●	10	5	10	130	30	P3210	1215-M4x0.5x9	80-T15
APMR-P3210-D10-C12-L130	●	10	5	12	130	30	P3212	1220-M5x0.5x9	80-T20
APMR-P3212-D12-C12-L130	●	12	6	12	130	32	P3216	1220-M5x0.5x12	
APMR-P3216-D16-C16-L175	●	16	8	16	175	75	P3220	1220-M5x0.5x15	
APMR-P3220-D20-C20-L200	●	20	10	20	200	100	P3225	1220-M6x0.75x20	AAL-05-4
APMR-P3225-D25-C25-L200	●	25	12.5	25	200	100	P3232	1204-M8x0.75x26	
APMR-P3232-D32-C32-L200	●	32	16	32	200	100			

WLTR Ucuna Uygunudur. / Compatible with WLTR Insert. / Под пластину WLTR

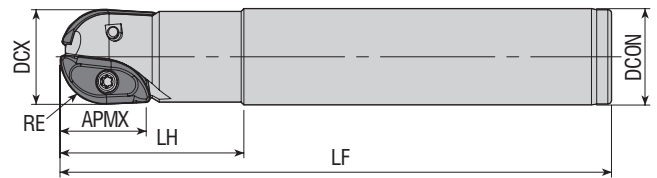

Takım Kodu Ordering Code Код для заказа	Stok Stock Наличие	Takım Ölçüleri (mm) Dimension (mm) Размеры (мм)						Kesici Uç Insert Пластина	Yedek Parçaları / Spare Parts / Запасные части	
		DCX	RE	DCON	LF	LH	APMX		Sıkma Vidası Screw Зажимной винт	Tork Anahtar Torx Key Торх Ключ
APMR-XP16-D16-C16-L150	●	16	8	16	150	40	16			
APMR-XP20-D20-C20-L150	●	20	10	20	150	50	20	XPHT 20R10T3	3010-M3.5x7	82-T10
APMR-XP25-D25-C25-L150	●	25	12.5	25	150	50	25	XPHT 25R1204	4015-M4x9	80-T15

R: Sağ / Right / Правый L: Sol / Left / Левый

● Stokta / In Stock / В наличии ○ Stokta Yok / Non Stock Item / Нет в наличии

ZCC Ucuna Uygunudur. / Compatible with ZCC Insert. / Под пластину ZCC



Sipariş Örneği/Ordering Example/Образец заказа

1 ad./pcs./шт. APMR-P3208-D08-C10-L110

Kesme Hesabı : S 377 / Cutting Calculation : P 377 / Расчет режимов резания: стр. 377

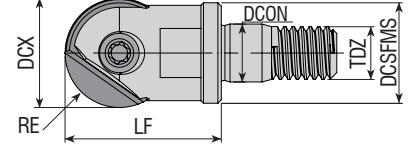

➤ **KÜRE UÇLU MODÜLER PARMAK FREZELER**
BALL NOSE MODULAR (SCREW TYPE) END MILLS
S-ТИП СМЕННЫЕ СФЕРИЧЕСКИЕ ФРЕЗЕРНЫЕ ГОЛОВКИ (КРЕПЛЕНИЕ ПОД РЕЗЬБУ)

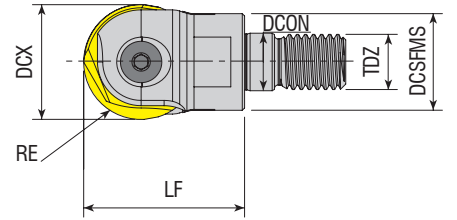

Takım Kodu Ordering Code Код для заказа	Stok Stock Наличие	Takım Ölçüleri (mm) Dimension (mm) Размеры (мм)						Kesici Uç Insert Пластина	Yedek Parçaları / Spare Parts / Запасные части		
		DCX	RE	DCSFMS	TDZ	LF	DCON		Sıkma Vidası Screw Зажимной винт	Tork Anahtar Torx Key Торх Ключ	
APMR-BNM12-D12-M06-L20	●	12	6	11	M06	20	6.5				
APMR-BNM16-D16-M08-L23	●	16	8	14.75	M08	23	8.5	BNM 160-S	1215-M4x13.5	80-T15	
APMR-BNM20-D20-M10-L30	●	20	10	18	M10	30	10.5	BNM 200-S	1220-M5x0.5x15	80-T20	

DJT Ucuna Uygunudur. / Compatible with DJT Insert. / Под пластину DJT



Takım Kodu Ordering Code Код для заказа	Stok Stock Наличие	Takım Ölçüleri (mm) Dimension (mm) Размеры (мм)						Kesici Uç Insert Пластина	Yedek Parçaları / Spare Parts / Запасные части		
		DCX	RE	DCSFMS	TDZ	LF	DCON		Sıkma Vidası Screw Зажимной винт	Tork Anahtar Torx Key Торх Ключ	
APMR-P3216-D16-M08-L25	●	16	8	14	M08	25	8.5				
APMR-P3220-D20-M10-L30	●	20	10	18	M10	30	10.5	P3220	1220-M5x0.5x15	80-T20	
APMR-P3225-D25-M12-L35	●	25	12.5	21	M12	35	12.5	P3225	1220-M6x0.75x20		
APMR-P3232-D32-M16-L43	●	32	16	30	M16	43	17	P3232	1204-M8x0.75x26	AAL-05-4	

R: Sağ / Right / Правый L: Sol / Left / Левый

● Stokta / In Stock / В наличии ○ Stokta Yok / Non Stock Item / Нет в наличии

WLTR Ucuna Uygunudur. / Compatible with WLTR Insert. / Под пластину WLTR

Sipariş Örneği/Ordering Example/Образец заказа

1 ad./pcs./шт. APMR-BNM12-D12-M06-L20

Kesme Hesabı : S 377 / Cutting Calculation : P 377 / Расчет режимов резания: стр. 377

Sıkma Tork Değeri : S 376 / Tightening Torque : P 376 / Момент затяжки: стр. 376



www.akkо.com.tr

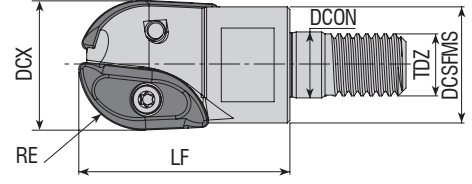

Takım Kodu Ordering Code Код для заказа	Stok Stock Наличие	Takım Ölçüleri (mm) Dimension (mm) Размеры (мм)						Kesici Uç Insert Пластина	Yedek Parçaları / Spare Parts / Запасные части				
		DCX	RE	DCSFMS	TDZ	LF	DCON		Sıkma Vidası Screw Зажимной винт	Tork Anahtar Torx Key Торх Ключ			
APMR-SWB225-D25-M12-L35	●	25	12.5	23.5	M12	35	12.5		4015-M4x9	80-T15			
APMR-SWB230-D30-M16-L43	●	30	15	28	M16	43	17					1020-M5x11	80-T20
APMR-SWB232-D32-M16-L43	●	32	16	30	M16	43	17						

DJT Ucuna Uygundur. / Compatible with DJT Insert. / Под пластину DJT

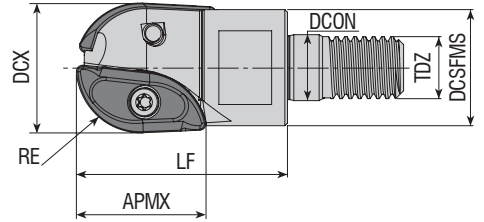

Takım Kodu Ordering Code Код для заказа	Stok Stock Наличие	Takım Ölçüleri (mm) Dimension (mm) Размеры (мм)							Kesici Uç Insert Пластина	Yedek Parçaları / Spare Parts / Запасные части				
		DCX	RE	DCSFMS	TDZ	LF	APMX	DCON		Sıkma Vidası Screw Зажимной винт	Tork Anahtar Torx Key Торх Ключ			
APMR-XP16-D16-M08-L25	●	16	8	14.75	M08	25	16	8.5		3008-M2.5x6	82-T08			
APMR-XP20-D20-M10-L30	●	20	10	18	M10	30	20	10.5					3010-M3.5x7	82-T10
APMR-XP25-D25-M12-L40	●	25	12.5	22	M12	40	25	12.5						



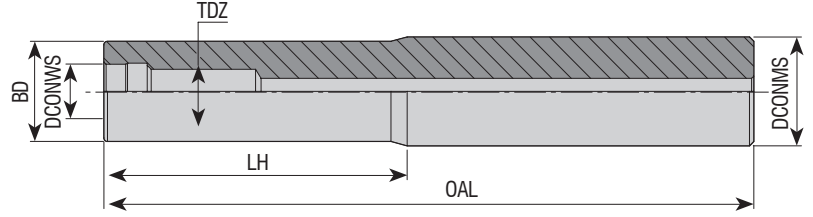

R: Sağ / Right / Правый L: Sol / Left / Левый
● Stokta / In Stock / В наличии ○ Stokta Yok / Non Stock Item / Нет в наличии
ZCC Ucuna Uygundur. / Compatible with ZCC Insert. / Под пластину ZCC

Sipariş Örneği/Ordering Example/Образец заказа
1 ad./pcs./шт. APMR-SWB225-D25-M12-L35
Kesme Hesabı : S 377 / Cutting Calculation : P 377 / Расчет режимов резания: стр. 377
Sıkma Tork Değeri : S 376 / Tightening Torque : P 376 / Момент затяжки: стр. 376

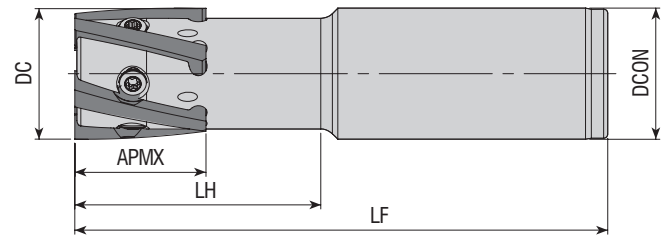

Takım Kodu Ordering Code Код для заказа	Stok Stock Наличие	Takım Ölçüleri (mm) Dimension (mm) Размеры (мм)					
		DCONMS	TDZ	DCONWS	BD	OAL	LH
AVTT-D13-C16-M08-L100-H	●	16	M08	8.5	13	100	40
AVTT-D15-C16-M08-L130-H	●	16	M08	8.5	15	130	70
AVTT-D18-C20-M10-L130-H	●	20	M10	10.5	18	130	70
AVTT-D18-C20-M10-L160-H	●	20	M10	10.5	18	160	80
AVTT-D23-C25-M12-L150-H	●	25	M12	12.5	23	150	70
AVTT-D23-C25-M12-L200-H	●	25	M12	12.5	23	200	100
AVTT-D23-C25-M12-L250-H	●	25	M12	12.5	23	250	150
AVTT-D30-C32-M16-L150-H	●	32	M16	17	30	150	70
AVTT-D30-C32-M16-L200-H	●	32	M16	17	30	200	100
AVTT-D30-C32-M16-L250-H	●	32	M16	17	30	250	150
AVTT-D30-C32-M16-L300-H	●	32	M16	17	30	300	200

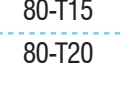

Takım Kodu Ordering Code Код для заказа	Stok Stock Наличие	Takım Ölçüleri (mm) Dimension (mm) Размеры (мм)						Kesici Uç Insert Пластина	Yedek Parçaları / Spare Parts / Запасные части	
		DC	ZEPF	DCON	LF	LH	APMX		Sikma Vidası Screw Зажимной винт	Tork Anahtar Torx Key Торх Ключ
ATM-H23-D23-C25-L100-Z02-H	●	23	2	25	100	30	27			
ATM-H32-D32-C32-L130-Z05-H	●	32	5	32	130	35	32			

R: Sağ / Right / Правый L: Sol / Left / Левый
● Stokta / In Stock / В наличии ○ Stokta Yok / Non Stock Item / Нет в наличии
CPT Ucuna Uygun / Compatible with CPT Insert. / Под пластину CPT.

Sipariş Örneği/Ordering Example/Образец заказа
1 ad./pcs./шт. AVTT-D13-C16-M08-L100-H
Kesme Hesabı : S 377 / Cutting Calculation : P 377 / Расчет режимов резания: стр. 377

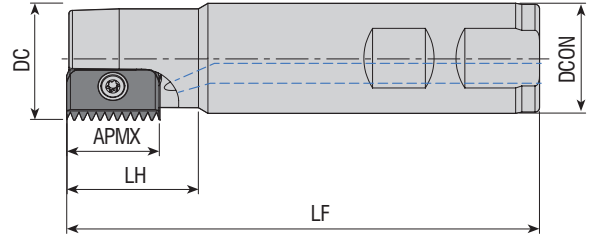

Takım Kodu Ordering Code Код для заказа	Stok Stock Наличие	Takım Ölçüleri (mm) Dimension (mm) Размеры (мм)						Kesici Uç Insert Пластина	Yedek Parçaları / Spare Parts / Запасные части		
		DC	ZAFP	DCON	LF	LH	APMX		Sıkma Vidası Screw Зажимной винт	Tork Anahtar Torx Key Торх Ключ	
ATM-C14-D14-W20-L100-Z01-H	●	14	1	20	100	25	14	C14	3008-M2.5x6 4015-M4x9	82-T08	
ATM-C21-D18-W20-L100-Z01-H	●	18	1	20	100	30	21				
ATM-C21-D21-W25-L125-Z01-H	●	21	1	25	125	40	21				
ATM-C21-D25-W20-L125-Z01-H	●	25	1	20	125	30	21	C21	4015-M4x11	80-T15	
ATM-C21-D28-W25-L90-Z01-H	●	28	1	25	90	30	21				
ATM-C21-D38-W32-L90-Z03-H	●	38	3	32	90	30	21				
ATM-C21-D38-W32-L120-Z03-H	●	38	3	32	120	30	21				
ATM-C21-D43-W32-L90-Z03-H	●	43	3	32	90	30	21	C30	1020-M5x14	80-T20	
ATM-C30-D29-W25-L150-Z01-H	●	29	1	25	150	50	30				

CPT Ucuna Uygun. / Compatible with CPT Insert. / Под пластину CPT.

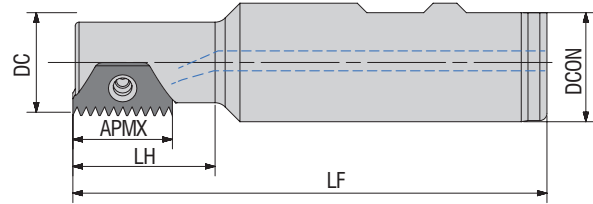



Takım Kodu Ordering Code Код для заказа	Stok Stock Наличие	Takım Ölçüleri (mm) Dimension (mm) Размеры (мм)						Kesici Uç Insert Пластина	Yedek Parçaları / Spare Parts / Запасные части		
		DC	ZAFP	DCON	LF	LH	APMX		Sıkma Vidası Screw Зажимной винт	Tork Anahtar Torx Key Торх Ключ	
ATM-3BEI-D21-W25-L100-Z01-H	●	21	1	25	100	30	21	3BEI..	1710-U5-40x8.8	82-T10	
ATM-3EI-D14-W20-L90-Z01-H	●	14	1	20	90	22	15.3				
ATM-3EI-D20-W25-L120-Z01-H	●	20	1	25	120	25	15.3	3E../3I..	1710-U5-40x7.2		

VRGS Ucuna Uygun. / Compatible with VRGS Insert. / Под пластину VRGS.

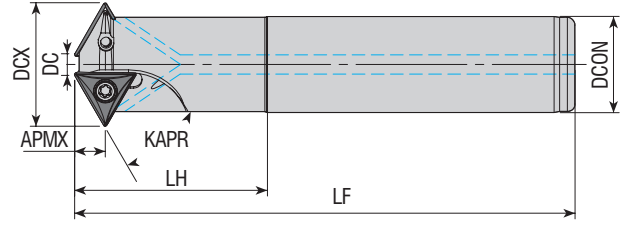

Sipariş Örneği/Ordering Example/Образец заказа
 1 ad./pcs./шт. ATM-C14-D14-W20-L100-Z01-H
 Kesme Hesabı : S 377/ Cutting Calculation : P 377 / Расчет режимов резания: стр. 377

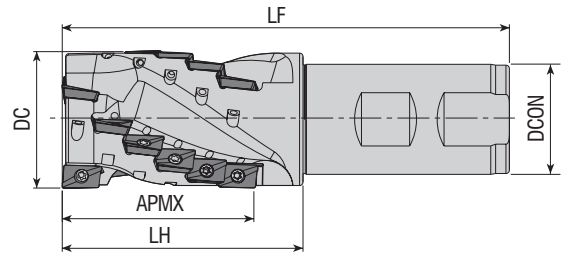
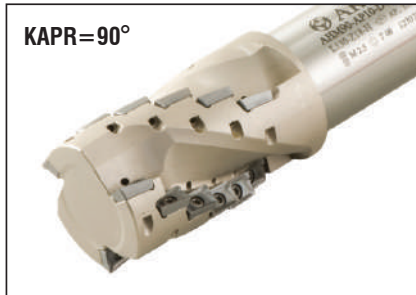

Takım Kodu Ordering Code Код для заказа	Stok Stock Наличие	Takım Ölçüleri (mm) Dimension (mm) Размеры (мм)							Kesici Uç Insert Пластина	Yedek Parçaları / Spare Parts / Запасные части		
		KAPR	DCX	DCON	DC	LF	LH	ZEPF		APMX	Sıkma Vidası Screw Зажимной винт	Tork Anahtar Torx Key Торх Ключ
ATM60-TB0601-D13-C10-L150-Z02-H	●	60	13	10	2.5	150	40	2	3.3			
ATM60-TC0902-D20.5-C16-L150-Z02-H	●	60	20.5	16	5.2	150	40	2	4.7	TBGT 060102	3006-M2x4	82-T06
ATM60-TC1102-D26-C20-L150-Z03-H	●	60	26	20	8.3	150	50	3	5.4	TC.T 090202	3007-M2.2x4.6	82-T07
ATM60-TC16T3-D32-C25-L150-Z02-H	●	60	32	25	6.4	150	50	2	8	TC.T 110202	3008-M2.5x6	82-T08
ATM60-TC16T3-D40-C32-L250-Z03-H	●	60	40	32	13.7	250	50	3	8	TC.T 16T304	4015-M3.5x9	80-T15

ISO Ucuna Uygundur. / Compatible with ISO Insert. / Под пластину ISO.



Takım Kodu Ordering Code Код для заказа	Stok Stock Наличие	Takım Ölçüleri (mm) Dimension (mm) Размеры (мм)						Kesici Uç Insert Пластина	Yedek Parçaları / Spare Parts / Запасные части		
		ZEPF		DC	DCON	APMX	LH		LF	Sıkma Vidası Screw Зажимной винт	Tork Anahtar Torx Key Торх Ключ
		Toplam Total Gesamt	Etkili Effective Effektiv								
AHM90-AP10-D20-W20-L087-Z0204	●	4	2	20	20	28	37	87			
AHM90-AP10-D20-W20-L087-Z0206	●	6	2	20	20	28	37	87			
AHM90-AP10-D25-W25-L105-Z0208-H	●	8	2	25	25	37	50	105			
AHM90-AP10-D32-W32-L115-Z0315-H	●	15	3	32	32	46	55	115			
AHM90-AP10-D40-W32-L130-Z0318-H	●	18	3	40	32	55	70	130			



ISO Ucuna Uygundur. / Compatible with ISO Insert. / Под пластину ISO.

Sipariş Örneği/Ordering Example/Образец заказа

1 ad./pcs./шт. ATM60-TB0601-D13-C10-L150-Z02-H

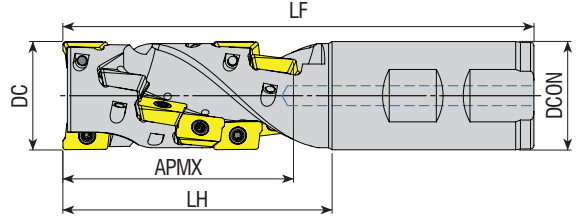
Kesme Hesabı : S 377/ Cutting Calculation : P 377 / Расчет режимов резания: стр. 377



Takım Kodu Ordering Code Код для заказа	Stok Stock Наличие	Takım Ölçüleri (mm) Dimension (mm) Размеры (мм)							Kesici Uç Insert Пластина	Yedek Parçaları / Spare Parts / Запасные части		
		ZEFP		DC	DCON	APMX	LH	LF		Sıkma Vidası Screw Зажимной винт	Tork Anahtar Torx Key Торх Ключ	
		Toplam Total Gesamt	Etkili Effective Efektiv									
AHM90-AP1204-D32-W32-L140-Z0212-H	●	12	2	32	32	68	80	140	 AP. 1204..			 3010-M3.5x9
AHM90-AP1204-D40-W32-L160-Z0321-H	●	21	3	40	32	79	100	160				

R: Sağ / Right / Правый L: Sol / Left / Левый

● Stokta / In Stock / В наличии ○ Stokta Yok / Non Stock Item / Нет в наличии
TGTC Ucuna Uygunudur. / Compatible with TGTC Insert. / Под пластину TGTC.

Sipariş Örneği/Ordering Example/Образец заказа

1 ad./pcs./шт. AHM90-AP1204-D32-W32-L140-Z0212-H

Kesme Hesabı : S 377 / Cutting Calculation : P 377 / Расчет режимов резания: стр. 377



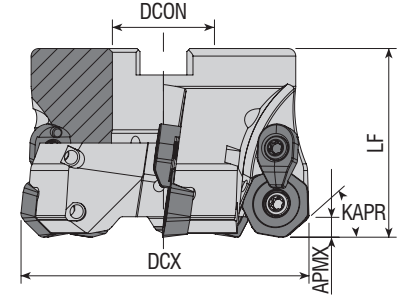

Takım Kodu Ordering Code Код для заказа	Stok Stock Наличие	Takım Ölçüleri (mm) Dimension (mm) Размеры (мм)					Kesici Uç Insert Пластина	Yedek Parçaları / Spare Parts / Запасные части				
		DCX	ZEFP	DCON	LF	APMX		Sıkma Vidası Screw Зажимной винт	Baskı Parçası Wedge Clamp Прижим	Baskı Vidası Clamp Screw Зажимной винт	Tork Anahtar Torx Key Торх Ключ	Montaj Vidası Mounting Screw Монтажный винт
AFM42C-XD0806-D063-A27-Z04-H	●	63	4	27	50	12	XDMW 0806..	4020-M4.5x12	ACK-24	4020-M4.5x12	80-T20	2510-M12x35
AFM42C-XD0806-D080-A27-Z05-H	●	80	5	27	50	12						
AFM42C-XD0806-D100-A32-Z06-H	●	100	6	32	63	12						
AFM42C-XD0806-D125-B40-Z07	●	125	7	40	63	12						
AFM42C-XD0806-D160-C40-Z08	●	160	8	40	63	12						
AFM42C-XD0806-D200-C60-Z09	●	200	9	60	63	12						

DJT Ucuna Uygundur. / Compatible with DJT Insert. / Под пластину DJT

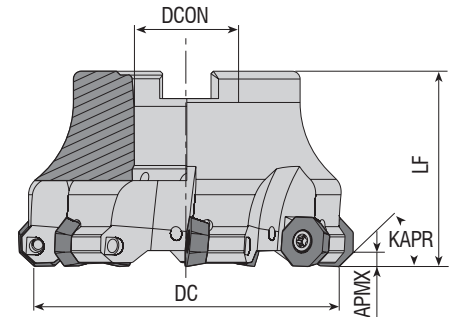
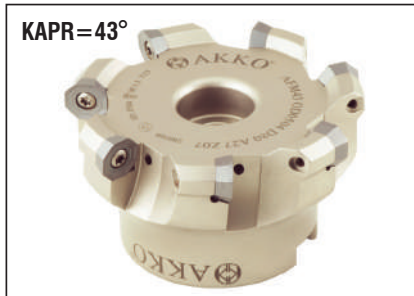

Takım Kodu Ordering Code Код для заказа	Stok Stock Наличие	Takım Ölçüleri (mm) Dimension (mm) Размеры (мм)					Kesici Uç Insert Пластина	Yedek Parçaları / Spare Parts / Запасные части			
		DC	ZEFP	DCON	LF	APMX		Sıkma Vidası Screw Зажимной винт	Tork Anahtar Torx Key Торх Ключ	Montaj Vidası Mounting Screw Монтажный винт	
AFM43-OD0504-D040-A16-Z04-H	●	40	4	16	40	3.5	OD.. 0504..	4015-M3.5x11	80-T15	2510-M12x35	
AFM43-OD0504-D050-A22-Z05-H	●	50	5	22	40	3.5					
AFM43-OD0504-D063-A22-Z06-H	●	63	6	22	40	3.5					
AFM43-OD0504-D080-A27-Z07-H	●	80	7	27	50	3.5					
AFM43-OD0504-D100-A32-Z08-H	●	100	8	32	50	3.5					

R: Sağ / Right / Правый L: Sol / Left / Левый

● Stokta / In Stock / В наличии ○ Stokta Yok / Non Stock Item / Нет в наличии
WLTR Ucuna Uygundur. / Compatible with WLTR Insert. / Под пластину WLTR

Sipariş Örneği/Ordering Example/Bestellbeispiel

1 ad./pcs./шт. AFM42C-XD0806-D063-A27-Z04-H

Kesme Hesabı : S 377 / Cutting Calculation : P 377 / Расчет режимов резания: стр. 377

Montaj Ölçüleri : S 374 / Mounting Reference : P 374 / Инструкция по установке фрез: стр. 374

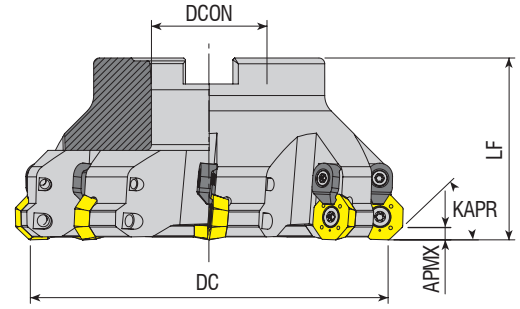
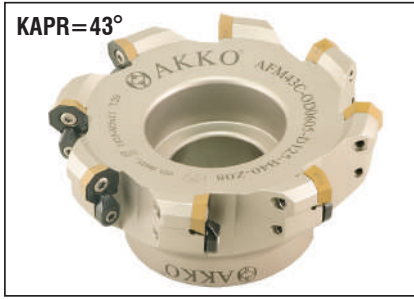

Takım Kodu Ordering Code Код для заказа	Stok Stock Наличие	Takım Ölçüleri (mm) Dimension (mm) Размеры (мм)					Kesici Uç Insert Пластина	Yedek Parçaları / Spare Parts / Запасные части				
		DC	ZEFP	DCON	LF	APMX		Sıkma Vidası Screw Зажимной винт	Baskı Parçası Wedge Clamp Прижим	Baskı Vidası Clamp Screw Зажимной винт	Tork Anahtar Torx Key Торх Ключ	Montaj Vidası Mounting Screw Монтажный винт
AFM43C-OD0605-D080-A27-Z06-H	●	80	6	27	50	4	OD.. 0605..	1020-M5x11	ACK-05	4015-M4x11	80-T20	2510-M12x35
AFM43C-OD0605-D100-A32-Z07-H	●	100	7	32	50	4						2514-M16x35
AFM43C-OD0605-D125-B40-Z08	●	125	8	40	63	4						-

WLTR-LMN Ucuna Uygunur. / Compatible with WLTR-LMN Insert./Под пластину WLTR-LMN

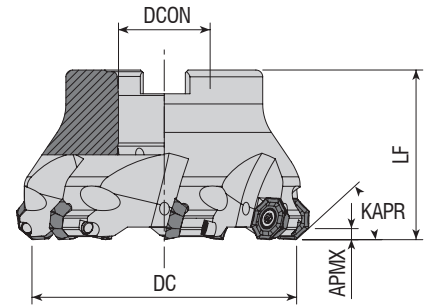

Takım Kodu Ordering Code Код для заказа	Stok Stock Наличие	Takım Ölçüleri (mm) Dimension (mm) Размеры (мм)					Kesici Uç Insert Пластина	Yedek Parçaları / Spare Parts / Запасные части			
		DC	ZEFP	DCON	LF	APMX		Sıkma Vidası Screw Зажимной винт	Tork Anahtar Torx Key Торх Ключ	Montaj Vidası Mounting Screw Монтажный винт	
AFM43-OF05T3-D050-A22-Z05-H	●	50	5	22	40	3	OF.. 05T3..	4015-M4x9	80-T15	2407-M10x30	
AFM43-OF05T3-D063-A22-Z06-H	●	63	6	22	40	3				2510-M12x35	
AFM43-OF05T3-D080-A27-Z07-H	●	80	7	27	50	3				-	
AFM43-OF05T3-D125-B40-Z09	●	125	9	40	63	3				-	

R: Sağ / Right / Правый L: Sol / Left / Левый
● Stokta / In Stock / В наличии ○ Stokta Yok / Non Stock Item / Нет в наличии
ISO Ucuna Uygunur. / Compatible with ISO Insert. / Под пластину ISO

Sipariş Örneği/Ordering Example/Bestellbeispiel
1 ad./pcs./шт. AFM43C-OD0605-D080-A27-Z06-H
Kesme Hesabı : S 377 / Cutting Calculation : P 377 / Расчет режимов резания: стр. 377
Montaj Ölçüleri : S 374 / Mounting Reference : P 374 / Инструкция по установке фрез: стр. 374

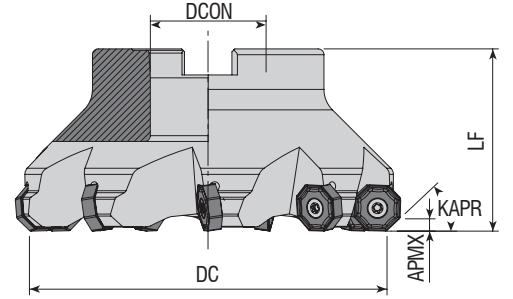

Takım Kodu Ordering Code Код для заказа	Stok Stock Наличие	Takım Ölçüleri (mm) Dimension (mm) Размеры (мм)					Kesici Uç Insert Пластина	Yedek Parçaları / Spare Parts / Залпасные части			
		DC	ZEFP	DCON	LF	APMX		Sıkma Vidası Screw Зажимной винт	Tork Anahtar Torx Key Торх Ключ	Montaj Vidası Mounting Screw Монтажный винт	
AFM43-ON0604-D050-A22-Z05-H	●	50	5	22	40	4	ON.. 0604..				2407-M10x30
AFM43-ON0604-D063-A22-Z06-H	●	63	6	22	40	4					
AFM43-ON0604-D080-A27-Z07-H	●	80	7	27	50	4					
AFM43-ON0604-D100-A32-Z08-H	●	100	8	32	50	4					
AFM43-ON0604-D125-B40-Z09	●	125	9	40	63	4					

ZCC Ucuna Uygunudur. / Compatible with ZCC Insert. / Под пластину ZCC

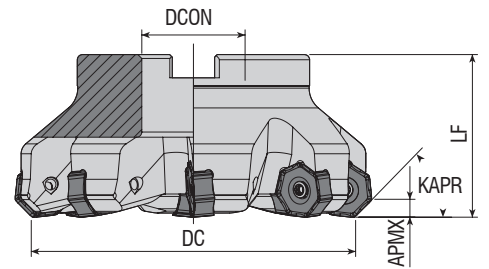
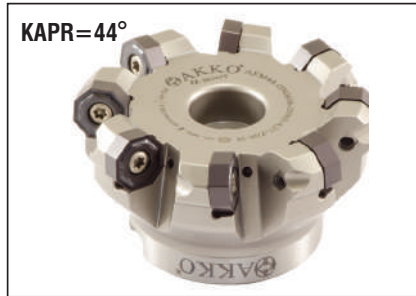

Takım Kodu Ordering Code Код для заказа	Stok Stock Наличие	Takım Ölçüleri (mm) Dimension (mm) Размеры (мм)					Kesici Uç Insert Пластина	Yedek Parçaları / Spare Parts / Залпасные части			
		DC	ZEFP	DCON	LF	APMX		Sıkma Vidası Screw Зажимной винт	Tork Anahtar Torx Key Торх Ключ	Montaj Vidası Mounting Screw Монтажный винт	
AFM44-ON0606-D063-A22-Z06-H	●	63	6	22	40	3.8	ONHX 0606..				2407-M10x30
AFM44-ON0606-D080-A27-Z08-H	●	80	8	27	50	3.8					
AFM44-ON0606-D100-A32-Z10-H	●	100	10	32	50	3.8					

R: Sağ / Right / Правый L: Sol / Left / Левый
● Stokta / In Stock / В наличии ○ Stokta Yok / Non Stock Item / Нет в наличии
PLBT Ucuna Uygunudur. / Compatible with PLBT Insert. / Под пластину PLBT.

Sipariş Örneği/Ordering Example/Bestellbeispiel
1 ad./pcs./шт. AFM43-ON0604-D050-A22-Z05-H
Kesme Hesabı : S 377 / Cutting Calculation : P 377 / Расчет режимов резания: стр. 377
Montaj Ölçüleri : S 374 / Mounting Reference : P 374 / Инструкция по установке фрез: стр. 374

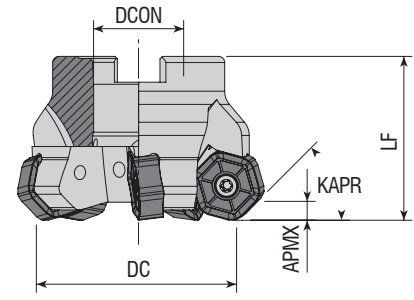

Takım Kodu Ordering Code Код для заказа	Stok Stock Наличие	Takım Ölçüleri (mm) Dimension (mm) Размеры (мм)					Kesici Uç Insert Пластина	Yedek Parçaları / Spare Parts / Запасные части		
		DC	ZEFP	DCON	LF	APMX		Sıkma Vidası Screw Зажимной винт	Tork Anahtar Torx Key Торх Ключ	Montaj Vidası Mounting Screw Монтажный винт
AFM45-HN0905-D050-A22-Z05-H	●	50	5	22	40	4.5	HN.. 0905..	4015-M4x11	80-T15	2407-M10x30
AFM45-HN0905-D063-A22-Z06-H	●	63	6	22	40	4.5				
AFM45-HN0905-D080-A27-Z07-H	●	80	7	27	50	4.5				
AFM45L-HN0905-D100-A32-Z08-H	●	100	8	32	50	4.5				
AFM45-HN0905-D125-B40-Z10	●	125	10	40	63	4.5				
AFM45L-HN0905-D125-B40-Z10	●	125	10	40	63	4.5				
AFM45-HN0905-D160-C40-Z12	●	160	12	40	63	4.5				
AFM45L-HN0905-D160-C40-Z12	●	160	12	40	63	4.5				
AFM45-HN0905-D200-C60-Z16	●	200	16	60	63	4.5				
AFM45L-HN0905-D200-C60-Z16	●	200	16	60	63	4.5				

WDA Ucuna Uygundur. / Compatible with WDA Insert. / Под пластину WDA

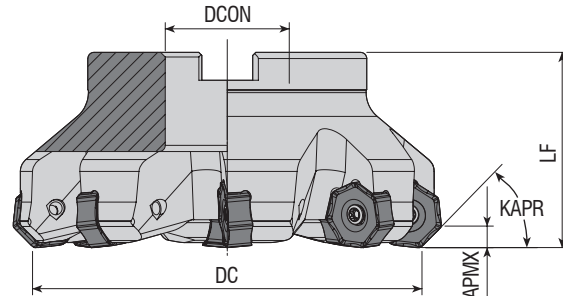
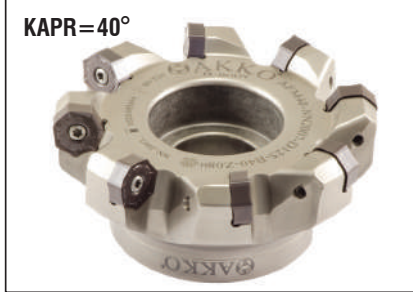

Takım Kodu Ordering Code Код для заказа	Stok Stock Наличие	Takım Ölçüleri (mm) Dimension (mm) Размеры (мм)					Kesici Uç Insert Пластина	Yedek Parçaları / Spare Parts / Запасные части		
		DC	ZEFP	DCON	LF	APMX		Sıkma Vidası Screw Зажимной винт	Tork Anahtar Torx Key Торх Ключ	Montaj Vidası Mounting Screw Монтажный винт
AFM40-NN2007-D080-A27-Z06-H	●	80	6	27	50	6	NNMU 2007..	1020-M5x14	80-T20	2514-M16x35
AFM40-NN2007-D100-B32-Z07-H	●	100	7	32	50	6				
AFM40-NN2007-D125-B40-Z08-H	●	125	8	40	63	6				
AFM40-NN2007-D160-C40-Z10	●	160	10	40	63	6				
AFM40-NN2007-D200-C60-Z12	●	200	12	60	63	6				

R: Sağ / Right / Правый L: Sol / Left / Левый

● Stokta / In Stock / В наличии ○ Stokta Yok / Non Stock Item / Нет в наличии

MTSBH Ucuna Uygundur. / Compatible with MTSBH Insert. / Под пластину MTSBH

Sipariş Örneği/Ordering Example/Образец заказа

1 ad./pcs./шт. AFM45-HN0905-D050-A22-Z05-H

Kesme Hesabı : S 377 / Cutting Calculation : P 377 / Расчет режимов резания: стр. 377

Montaj Ölçüleri : S 374 / Mounting Reference : P 374 / Инструкция по установке фрез: стр. 374

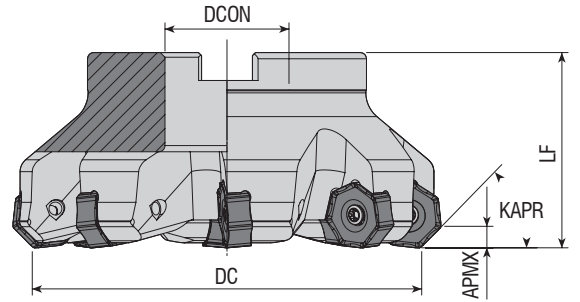
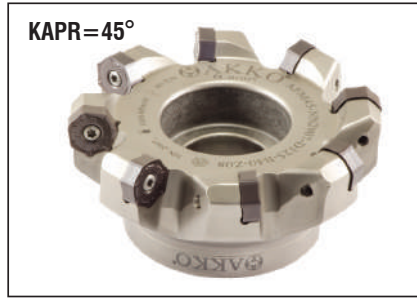

Takım Kodu Ordering Code Код для заказа	Stok Stock Наличие	Takım Ölçüleri (mm) Dimension (mm) Размеры (мм)					Kesici Uç Insert Пластина	Yedek Parçaları / Spare Parts / Запасные части		
		DC	ZAFP	DCON	LF	APMX		Sıkma Vidası Screw Зажимной винт	Tork Anahtar Torx Key Торх Ключ	Montaj Vidası Mounting Screw Монтажный винт
new AFM45-NN2007-D063-A22-Z05-H	●	63	5	22	50	6	NNMU 2007..	1020-M5x14	80-T20	2508-M10x30
new AFM45-NN2007-D080-A27-Z06-H	●	80	6	27	50	6				2510-M12x35
AFM45-NN2007-D100-A32-Z07-H	●	100	7	32	50	6				2514-M16x35
AFM45-NN2007-D125-B40-Z08	●	125	8	40	63	6				
AFM45-NN2007-D160-C40-Z10	●	160	10	40	63	6				

R: Sağ / Right / Правый L: Sol / Left / Левый
● Stokta / In Stock / В наличии ○ Stokta Yok / Non Stock Item / Нет в наличии
MTSBH Ucuna Uygunudur. / Compatible with MTSBH Insert. / Под пластину MTSBH

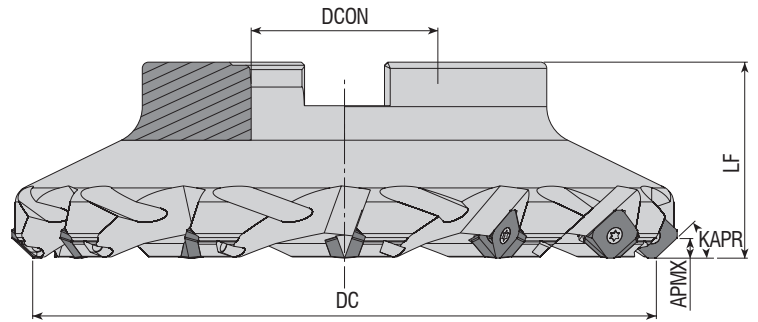

Takım Kodu Ordering Code Код для заказа	Stok Stock Наличие	Takım Ölçüleri (mm) Dimension (mm) Размеры (мм)					Kesici Uç Insert Пластина	Yedek Parçaları / Spare Parts / Запасные части		
		DC	ZAFP	DCON	LF	APMX		Sıkma Vidası Screw Зажимной винт	Tork Anahtar Torx Key Торх Ключ	Montaj Vidası Mounting Screw Монтажный винт
AFM45-SE12-D050-A22-Z04-H	●	50	4	22	40	6	SE.. 12T3.. R245-12T3..	4015-M3.5x11	80-T15	2407-M10x30
AFM45L-SE12-D050-A22-Z04-H	●	50	4	22	40	6				2510-M12x35
AFM45-SE12-D063-A22-Z05-H	●	63	5	22	40	6				2514-M16x35
AFM45L-SE12-D063-A22-Z05-H	●	63	5	22	40	6				
AFM45-SE12-D080-A27-Z06-H	●	80	6	27	50	6				
AFM45L-SE12-D080-A27-Z06-H	●	80	6	27	50	6				
AFM45-SE12-D100-A32-Z07-H	●	100	7	32	50	6				
AFM45-SE12-D125-B40-Z08	●	125	8	40	63	6				
AFM45-SE12-D160-C40-Z10	●	160	10	40	63	6				
AFM45L-SE12-D160-C40-Z10	●	160	10	40	63	6				
AFM45-SE12-D200-C60-Z12	●	200	12	60	63	6				

ZCC-SNDVK Ucuna Uygunudur. / Compatible with ZCC-SNDVK Insert. / Под пластину ZCC-SNDVK.

Sipariş Örneği/Ordering Example/Образец заказа

1 ad./pcs./шт. AFM45-NN2007-D063-A22-Z05-H

Kesme Hesabı : S 377 / Cutting Calculation : P 377 / Расчет режимов резания: стр. 377

Montaj Ölçüleri : S 374 / Mounting Reference : P 374 / Инструкция по установке фрез: стр. 374

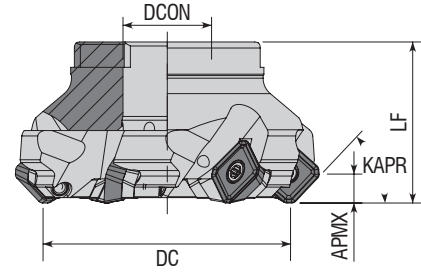
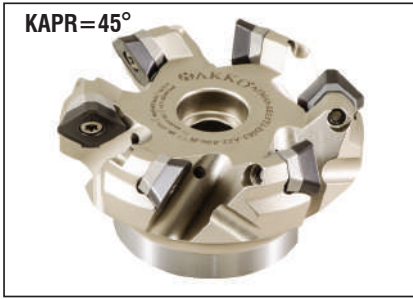

Takım Kodu Ordering Code Код для заказа	Stok Stock Наличие	Takım Ölçüleri (mm) Dimension (mm) Размеры (мм)					Kesici Uç Insert Пластина	Yedek Parçaları / Spare Parts / Запасные части				
		DC	ZFP	DCON	LF	APMX		Altlık Screw Unterlage	Altlık Vidası Wedge Clamp Винт опорной пластины	Sıkma Vidası Screw Зажимной винт	Tork Anahtar Torx Key Торх Ключ	Montaj Vidası Mounting Screw Монтажный винт
AFM45-SE13-D050-A22-Z04-H	●	50	4	22	40	6	SEMT 13T3..	AASE-3-0001	AAV-16-M3.5x8	4015-M3.5x11	80-T15	2407-M10x30
AFM45-SE13-D063-A22-Z05-H	●	63	5	22	40	6						
AFM45-SE13-D080-A27-Z06-H	●	80	6	27	50	6						
AFM45S-SE13-D050-A22-Z05-H	●	50	5	22	40	6						
AFM45S-SE13-D063-A22-Z06-H	●	63	6	22	40	6						
AFM45S-SE13-D080-A27-Z08-H	●	80	8	27	50	6						
AFM45S-SE13-D100-A32-Z10-H	●	100	10	32	50	6						
AFM45S-SE13-D125-B40-Z12	●	125	12	40	63	6						

R: Sağ / Right / Правый L: Sol / Left / Левый
● Stokta / In Stock / В наличии ○ Stokta Yok / Non Stock Item / Нет в наличии
SMTM-DJT Ucuna Uygundur. / Compatible with SMTM-DJT Insert. / Под пластину SMTM-DJT.

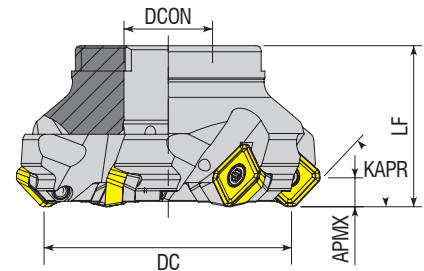
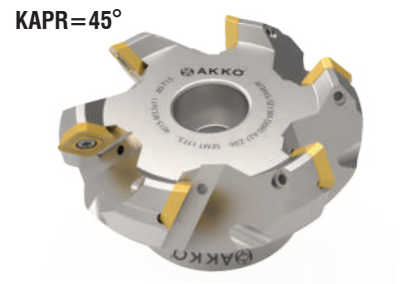

Takım Kodu Ordering Code Код для заказа	Stok Stock Наличие	Takım Ölçüleri (mm) Dimension (mm) Размеры (мм)					Kesici Uç Insert Пластина	Yedek Parçaları / Spare Parts / Запасные части		
		DC	ZFP	DCON	LF	APMX		Sıkma Vidası Screw Зажимной винт	Tork Anahtar Torx Key Торх Ключ	Montaj Vidası Mounting Screw Монтажный винт
AFM45-SE13M-D050-A22-Z04-H	●	50	4	22	40	6	SEMT 13T3..	4015-M3.5x11	80-T15	2508-M10x30
AFM45-SE13M-D063-A22-Z05-H	●	63	5	22	40	6				
AFM45-SE13M-D080-A27-Z06	●	80	6	27	50	6				
AFM45-SE13M-D100-A32-Z07	●	100	7	32	50	6				
AFM45-SE13M-D125-B40-Z08	●	125	8	40	63	6				

MTSBH Ucuna Uygundur. / Compatible with MTSBH Insert. / Под пластину MTSBH.

Sipariş Örneği/Ordering Example/Образец заказа

1 ad./pcs./шт. AFM45-SE13-D050-A22-Z04-H

Kesme Hesabı : S 377 / Cutting Calculation : P 377 / Расчет режимов резания: стр. 377

Montaj Ölçüleri : S 374 / Mounting Reference : P 374 / Инструкция по установке фрез: стр. 374



KAPR=45°

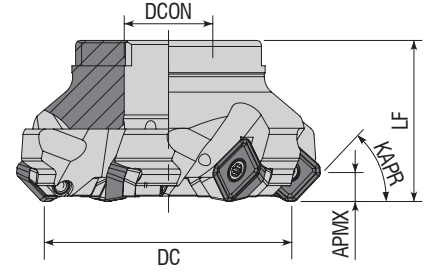

Takım Kodu Ordering Code Код для заказа	Stok Stock Наличие	Takım Ölçüleri (mm) Dimension (mm) Размеры (мм)					Kesici Uç Insert Пластина	Yedek Parçaları / Spare Parts / Запасные части					
		DC	ZEFP	DCON	LF	APMX		Altlık Screw Underlage	Altlık Vidası Wedge Clamp Винт опорной пластины	Sıkma Vidası Screw Зажимной винт	Tork Anahtar Torx Key Торх Ключ	Montaj Vidası Mounting Screw Монтажный винт	
AFM45S-SE13M-D050-A22-Z04-H	●	50	4	22	40	6	SEMT 13T3..	AASE-3-0001	AAV-16-M3.5x8	4015-M3.5x12	80-T15	2508-M10x30	
AFM45S-SE13M-D063-A22-Z05-H	●	63	5	22	40	6							2510-M12x35
AFM45S-SE13M-D080-A27-Z06	●	80	6	27	50	6							2514-M16x35
AFM45S-SE13M-D100-A32-Z07	●	100	7	32	50	6							-
AFM45S-SE13M-D125-B40-Z08	●	125	8	40	63	6							-

MTSBH Ucuna Uygunudur. / Compatible with MTSBH Insert. / Под пластину MTSBH.

KAPR=45°

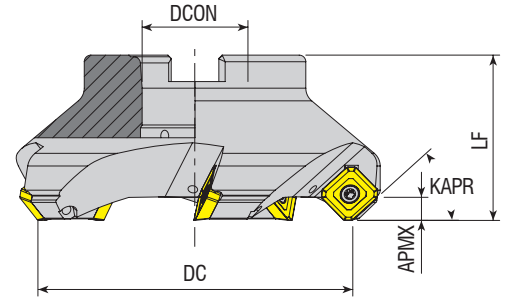

Takım Kodu Ordering Code Код для заказа	Stok Stock Наличие	Takım Ölçüleri (mm) Dimension (mm) Размеры (мм)					Kesici Uç Insert Пластина	Yedek Parçaları / Spare Parts / Запасные части			
		DC	ZEFP	DCON	LF	APMX		Sıkma Vidası Screw Зажимной винт	Tork Anahtar Torx Key Торх Ключ	Montaj Vidası Mounting Screw Монтажный винт	
AFM45-SE14M4-D063-A22-Z04-H	●	63	4	22	40	7	SE.. 14M4..	4015-M3.5x11	80-T15	2407-M10x30	
AFM45-SE14M4-D080-A27-Z05-H	●	80	5	27	50	7					2510-M12x35
AFM45-SE14M4-D100-A32-Z05-H	●	100	5	32	50	7					2514-M16x35
AFM45-SE14M4-D125-B40-Z06	●	125	6	40	63	7					-
AFM45-SE14M4-D160-C40-Z07	●	160	7	40	63	7					-

R: Sağ / Right / Правый L: Sol / Left / Левый

● Stokta / In Stock / В наличии ○ Stokta Yok / Non Stock Item / Нет в наличии

KRLY Ucuna Uygunudur. / Compatible with KRLY Insert. / Под пластину KRLY.

Sipariş Örneği/Ordering Example/Образец заказа

1 ad./pcs./шт. AFM45S-SE13M-D050-A22-Z04-H

Kesme Hesabı : S 377 / Cutting Calculation : P 377 / Расчет режимов резания: стр. 377

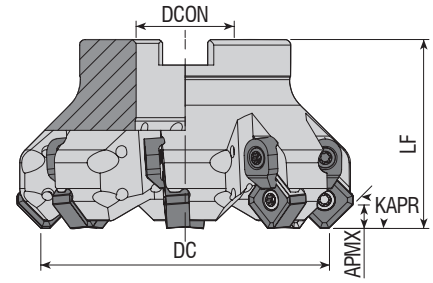
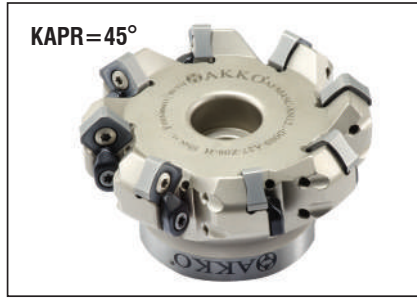

Takım Kodu Ordering Code Код для заказа	Stok Stock Наличие	Takım Ölçüleri (mm) Dimension (mm) Размеры (мм)					Kesici Uç Insert Пластина	Sıkma Vidası Screw Зажимной винт	Baskı Parçası Wedge Clamp Прижим	Baskı Vidası Clamp Screw Зажимной винт	Tork Anahtar Torx Key Торх Ключ	Montaj Vidası Mounting Screw Монтажный винт
		DC	ZEFP	DCON	LF	APMX						
AFM45C-SN12..-D050-A22-Z04-H	●	50	4	22	42	6	SN.. 12..	1015-M4x11	ACK-05	4015-M4x11	80-T15	2407-M10x30
AFM45C-SN12..-D050-A22-Z05-H	●	50	5	22	42	6						
AFM45C-SN12..-D063-A22-Z06-H	●	63	6	22	42	6						
AFM45C-SN12..-D063-A22-Z07-H	●	63	7	22	42	6						
AFM45CL-SN12..-D063-A22-Z07-H	●	63	7	22	42	6						
AFM45C-SN12..-D080-A27-Z07-H	●	80	7	27	52	6						
AFM45C-SN12..-D080-A27-Z08-H	●	80	8	27	52	6						
AFM45CL-SN12..-D080-A27-Z08-H	●	80	8	27	52	6						
AFM45C-SN12..-D100-A32-Z08-H	●	100	8	32	52	6						
AFM45C-SN12..-D100-A32-Z10-H	●	100	10	32	52	6						
AFM45CL-SN12..-D100-A32-Z10-H	●	100	10	32	52	6						
AFM45C-SN12..-D125-B40-Z11	●	125	11	40	65	6						
AFM45CL-SN12..-D125-B40-Z11	●	125	11	40	65	6						
AFM45C-SN12..-D160-C40-Z12	●	160	12	40	65	6						
AFM45C-SN12..-D200-C60-Z14	●	200	14	60	65	6						
AFM45CL-SN12..-D200-C60-Z14	●	200	14	60	65	6						

R: Sağ / Right / Правый L: Sol / Left / Левый

● Stokta / In Stock / В наличии ○ Stokta Yok / Non Stock Item / Нет в наличии

WLTR-LMN-ACHTK Ucuna Uygundur. / Compatible with WLTR-LMN-ACHTK Insert. / Под пластину WLTR-LMN-ACHTK

Sipariş Örneği/Ordering Example/Образец заказа

1 ad./pcs./шт. AFM45C-SN12..-D050-A22-Z04-H

Kesme Hesabı : S 377 / Cutting Calculation : P 377 / Расчет режимов резания: стр. 377

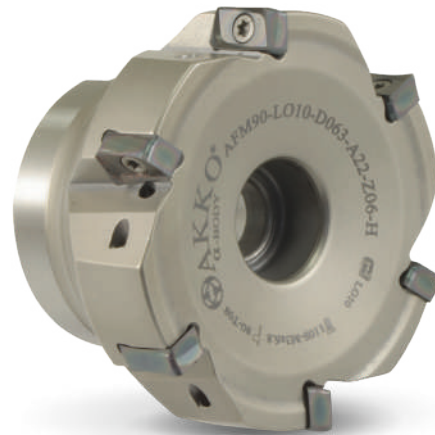
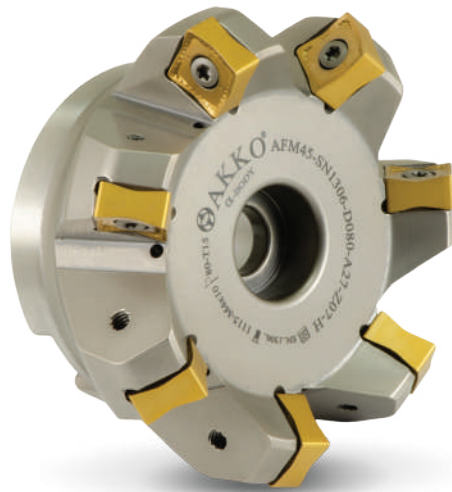

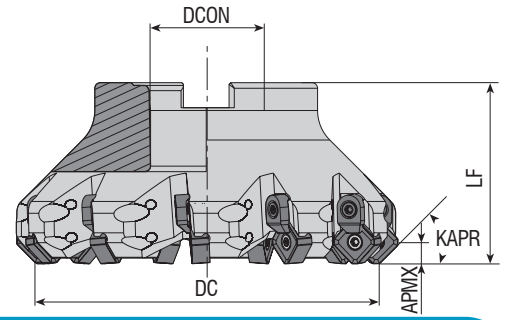
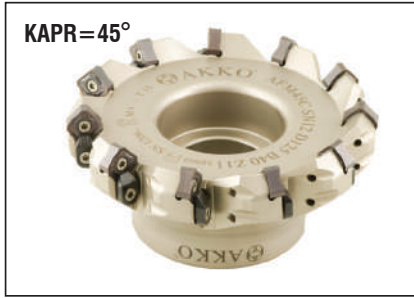

Takım Kodu Ordering Code Код для заказа	Stok Stock Наличие	Takım Ölçüleri (mm) Dimension (mm) Размеры (мм)					Kesici Uç Insert Пластина	Yedek Parçaları / Spare Parts / Запасные части						
		DC	ZEFP	DCON	LF	APMX		Sıkma Vidası Screw Зажимной винт	Baskı Parçası Wedge Clamp Прижим	Baskı Vidası Clamp Screw Зажимной винт	Tork Anahtar Torx Key Торкс Ключ	Montaj Vidası Mounting Screw Монтажный винт		
AFM45C-SN1206-D050-A22-Z04-H	●	50	4	22	42	6	SN.. 1206..	4015-M4x11	ACK-05	4015-M4x11	80-T15	2510-M12x35		
AFM45CL-SN1206-D050-A22-Z05-H	●	50	5	22	42	6								
AFM45C-SN1206-D050-A22-Z05-H	●	50	5	22	42	6								
AFM45C-SN1206-D063-A22-Z06-H	●	63	6	22	42	6							2407-M10x30	
AFM45C-SN1206-D063-A22-Z07-H	●	63	7	22	42	6								
AFM45CL-SN1206-D063-A22-Z07-H	●	63	7	22	42	6								
AFM45C-SN1206-D080-A27-Z07-H	●	80	7	27	52	6								
AFM45C-SN1206-D080-A27-Z08-H	●	80	8	27	52	6							2510-M12x35	
AFM45CL-SN1206-D080-A27-Z08-H	●	80	8	27	52	6								
AFM45C-SN1206-D100-A32-Z08-H	●	100	8	32	52	6								
AFM45C-SN1206-D100-A32-Z10-H	●	100	10	32	52	6							2514-M16x35	
AFM45CL-SN1206-D100-A32-Z10-H	●	100	10	32	52	6								
AFM45C-SN1206-D125-B40-Z11	●	125	11	40	65	6								
AFM45CL-SN1206-D125-B40-Z11	●	125	11	40	65	6								
AFM45C-SN1206-D160-C40-Z12	●	160	12	40	65	6								
new AFM45CL-SN1206-D160-C40-Z12	●	160	12	40	65	6							1015-M4x11	-
AFM45C-SN1206-D200-C60-Z14	●	200	14	60	65	6								
AFM45CL-SN1206-D200-C60-Z14	●	200	14	60	65	6								

KRLY-PLBT-BHLR Ucuna Uygunudur. / Compatible with KRLY-PLBT-BHLR Insert. / Под пластину KRLY-PLBT-BHLR

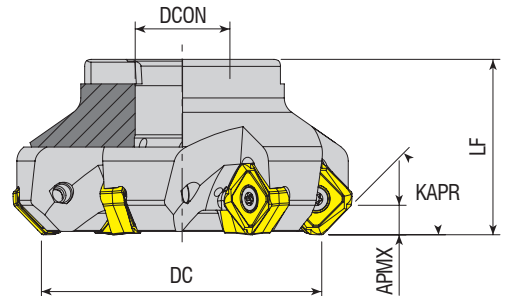
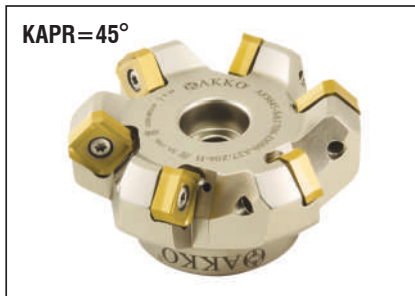

Takım Kodu Ordering Code Код для заказа	Stok Stock Наличие	Takım Ölçüleri (mm) Dimension (mm) Размеры (мм)					Kesici Uç Insert Пластина	Yedek Parçaları / Spare Parts / Запасные части		
		DC	ZEFP	DCON	LF	APMX		Sıkma Vidası Screw Зажимной винт	Tork Anahtar Torx Key Торкс Ключ	Montaj Vidası Mounting Screw Монтажный винт
AFM45-SA1706-D080-A27-Z06-H	●	80	6	27	50	8.4	SAKU 1706..	1020-M5x14	80-T20	2510-M12x35
AFM45-SA1706-D100-A32-Z07-H	●	100	7	32	50	8.4				2514-M16x35
AFM45-SA1706-D125-B40-Z09	●	125	9	40	63	8.4				-

R: Sağ / Right / Правый L: Sol / Left / Левый

● Stokta / In Stock / В наличии ○ Stokta Yok / Non Stock Item / Нет в наличии

CRTZT Ucuna Uygunudur. / Compatible with CRTZT Insert. / Под пластину CRTZT

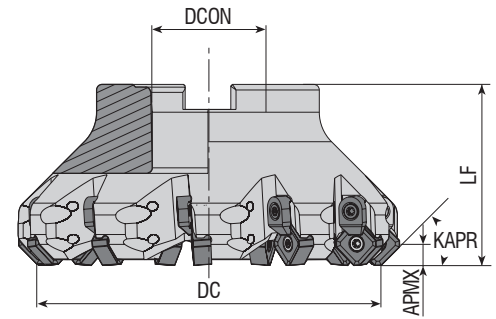

Takım Kodu Ordering Code Код для заказа	Stok Stock Наличие	Takım Ölçüleri (mm) Dimension (mm) Размеры (мм)					Kesici Uç Insert Пластина	Yedek Parçaları / Spare Parts / Запасные части					
		DC	ZEFP	DCON	LF	APMX		Sıkma Vidası Screw Зажимной винт	Baskı Parçası Wedge Clamp Прижим	Baskı Vidası Clamp Screw Зажимной винт	Tork Anahtar Torx Key Торх Ключ	Montaj Vidası Mounting Screw Монтажный винт	
AFM45C-SN12Z-D050-A22-Z05-H	●	50	5	22	42	6	SNEG 1205..						2407-M10X30
AFM45C-SN12Z-D063-A22-Z06-H	●	63	6	22	42	6							
AFM45C-SN12Z-D080-A27-Z07-H	●	80	7	27	52	6							
AFM45C-SN12Z-D100-A32-Z09-H	●	100	9	32	52	6							
AFM45C-SN12Z-D125-B40-Z11	●	125	11	40	65	6							
AFM45C-SN12Z-D160-C40-Z12	●	160	12	60	65	6							
AFM45C-SN12Z-D200-C60-Z14	●	200	14	60	65	6							

ZCC Ucuna Uygunudur. / Compatible with ZCC Insert. / Под пластину ZCC

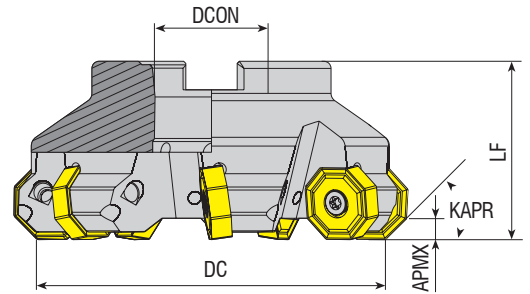

Takım Kodu Ordering Code Код для заказа	Stok Stock Наличие	Takım Ölçüleri (mm) Dimension (mm) Размеры (мм)					Kesici Uç Insert Пластина	Yedek Parçaları / Spare Parts / Запасные части			
		DC	ZEFP	DCON	LF	APMX		Sıkma Vidası Screw Зажимной винт	Tork Anahtar Torx Key Торх Ключ	Montaj Vidası Mounting Screw Монтажный винт	
new AFM45-ON0806-D050-A22-Z04-H	●	50	4	22	40	5.5	ON.. 0806..				-
AFM45-ON0806-D063-A22-Z05-H	●	63	5	22	40	5.5					2508-M10x30
AFM45-ON0806-D063-A22-Z06-H	●	63	6	22	40	5.5					2508-M2510-M10X30
new AFM45-ON0806-D063-A22-Z07-H	●	63	7	22	40	5.5					2510-M12x35
AFM45-ON0806-D080-A27-Z06-H	●	80	6	27	50	5.5					2514-M16x35
AFM45-ON0806-D080-A27-Z08-H	●	80	8	27	50	5.5					
AFM45-ON0806-D100-A32-Z07-H	●	100	7	32	50	5.5					
new AFM45-ON0806-D100-A32-Z10	●	100	10	32	50	5.5					
AFM45-ON0806-D100-A32-Z10-H	●	100	10	32	50	5.5					
new AFM45L-ON0806-D100-A32-Z10-H	●	100	10	32	50	5.5					
AFM45-ON0806-D125-B40-Z08	●	125	8	40	63	5.5					
new AFM45L-ON0806-D125-B40-Z08	●	125	8	40	63	5.5					
AFM45-ON0806-D125-B40-Z12	●	125	12	40	63	5.5					
AFM45-ON0806-D160-C40-Z10	●	160	10	40	63	5.5					
AFM45-ON0806-D160-C40-Z14	●	160	14	40	63	5.5					
AFM45-ON0806-D200-C60-Z12	●	200	12	60	63	5.5					
AFM45-ON0806-D250-C60-Z14	●	250	14	60	63	5.5					
AFM45-ON0806-D315-D60-Z16	●	315	16	60	63	5.5					

R: Sağ / Right / Правый L: Sol / Left / Левый

● Stokta / In Stock / В наличии ○ Stokta Yok / Non Stock Item / Нет в наличии

ISO Ucuna Uygunudur. / Compatible with ISO Insert. / Под пластину ISO

Sipariş Örneği/Ordering Example/Образец заказа

1 ad./pcs./шт. AFM45C-SN12Z-D050-A22-Z05-H

Kesme Hesabı : S 377 / Cutting Calculation : P 377 / Расчет режимов резания: стр. 377

Montaj Ölçüleri : S 374/ Mounting Reference : P 374 / Инструкция по установке фрез: стр. 374

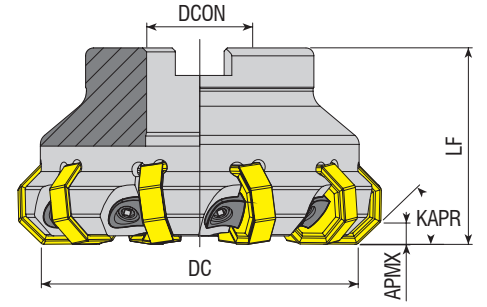

Takım Kodu Ordering Code Код для заказа	Stok Stock Наличие	Takım Ölçüleri (mm) Dimension (mm) Размеры (мм)					Kesici Uç Insert Пластина	Yedek Parçaları / Spare Parts / Запасные части				
		DC	ZEFP	DCON	LF	APMX		Baskı Parçası Wedge Clamp Прижим	Baskı Vidası Clamp Screw Зажимной винт	Anahtar Allen Key Ключ	Montaj Vidası Mounting Screw Монтажный винт	
new AFM45C-ON0806-D063-A22-Z08	●	63	8	22	50	5.5	ON.. 0806..	ACK-26	AKV-26-M6x0.75x20	AAL-03-3	-	2508-M10x30
AFM45C-ON0806-D080-A27-Z10	●	80	10	27	50	5.5						2510-M12x35
AFM45C-ON0806-D100-A32-Z14	●	100	14	32	50	5.5						2514-M16x35
AFM45C-ON0806-D125-B40-Z18	●	125	18	40	63	5.5						-
AFM45C-ON0806-D160-C40-Z22	●	160	22	40	63	5.5						-

ISO Ucuna Uygundur. / Compatible with ISO Insert. / Под пластину ISO

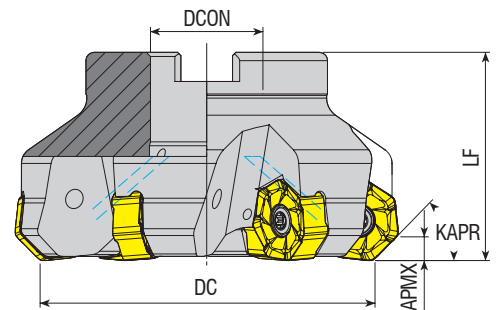

Takım Kodu Ordering Code Код для заказа	Stok Stock Наличие	Takım Ölçüleri (mm) Dimension (mm) Размеры (мм)					Kesici Uç Insert Пластина	Sıkma Vidası Screw Зажимной винт	Yedek Parçaları / Spare Parts / Запасные части				
		DC	ZEFP	DCON	LF	APMX			Baskı Parçası Wedge Clamp Прижим	Baskı Vidası Clamp Screw Зажимной винт	Tork Anahtar Torx Key Торх Ключ	Montaj Vidası Mounting Screw Монтажный винт	
AFM45-XN0906-D063-A22-Z06-H	●	63	6	22	50	5	XNMU 0906..	1120-M5x13	-	-	80-T20	2407-M10x30	
AFM45-XN0906-D080-A27-Z06-H	●	80	6	27	50	5						2510-M12x35	
AFM45-XN0906-D100-A32-Z07-H	●	100	7	32	55	5						2514-M16x35	
AFM45-XN0906-D125-B40-Z08	●	125	8	40	63	5						-	

R: Sağ / Right / Правый L: Sol / Left / Левый
● Stokta / In Stock / В наличии ○ Stokta Yok / Non Stock Item / Нет в наличии
TGTC Ucuna Uygundur. / Compatible with TGTC Insert. / Под пластину TGTC

Sipariş Örneği/Ordering Example/Образец заказа
1 ad./pcs./шт. AFM45C-ON0806-D063-A22-Z08
Kesme Hesabı : S 377 / Cutting Calculation : P 377 / Расчет режимов резания: стр. 377
Montaj Ölçüleri : S 374 / Mounting Reference : P 374 / Инструкция по установке фрез: стр. 374



KAPR=45°

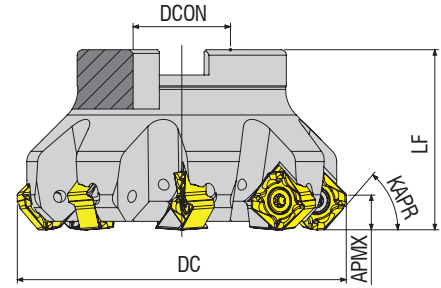
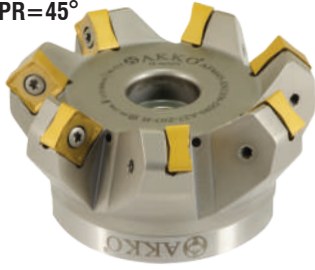

Takım Kodu Ordering Code Код для заказа	Stok Stock Наличие	Takım Ölçüleri (mm) Dimension (mm) Размеры (мм)					Kesici Uç Insert Пластина	Yedek Parçaları / Spare Parts / Запасные части		
		DC	ZEFP	DCON	LF	APMX		Sıkma Vidası Screw Зажимной винт	Tork Anahtar Torx Key Торх Ключ	Montaj Vidası Mounting Screw Монтажный винт
AFM45-SN1306-D050-A22-Z05-H	●	50	5	22	40	7	SNGX 1306..			
AFM45-SN1306-D063-A22-Z06-H	●	63	6	22	40	7				
AFM45-SN1306-D080-A27-Z07-H	●	80	7	27	50	7				
AFM45-SN1306-D100-A32-Z08-H	●	100	8	32	50	7				

TGTC Ucuna Uygunudur. / Compatible with TGTC Insert. / Под пластину TGTC.

KAPR=66°

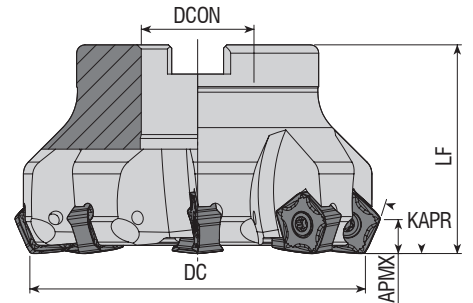

Takım Kodu Ordering Code Код для заказа	Stok Stock Наличие	Takım Ölçüleri (mm) Dimension (mm) Размеры (мм)					Kesici Uç Insert Пластина	Yedek Parçaları / Spare Parts / Запасные части		
		DC	ZEFP	DCON	LF	APMX		Sıkma Vidası Screw Зажимной винт	Tork Anahtar Torx Key Торх Ключ	Montaj Vidası Mounting Screw Монтажный винт
AFM66-PN0905-D050-A22-Z05	●	50	5	22	40	8	PNMU 0905..			
AFM66-PN0905-D063-A22-Z06	●	63	6	22	40	8				
AFM66-PN0905-D080-A27-Z08	●	80	8	27	50	8				
AFM66-PN0905-D100-A32-Z10	●	100	10	32	50	8				
AFM66-PN0905-D125-B40-Z12	●	125	12	40	63	8				

R: Sağ / Right / Правый L: Sol / Left / Левый
● Stokta / In Stock / В наличии ○ Stokta Yok / Non Stock Item / Нет в наличии
KYCR Ucuna Uygunudur. / Compatible with KYCR Insert. / Под пластину KYCR

Sipariş Örneği/Ordering Example/Образец заказа
1 ad./pcs./шт. AFM45-SN1306-D050-A22-Z05-H
Kesme Hesabı : S 377 / Cutting Calculation : P 377 / Расчет режимов резания: стр. 377
Montaj Ölçüleri : S 374/ Mounting Reference : P 374 / Инструкция по установке фрез: стр. 374

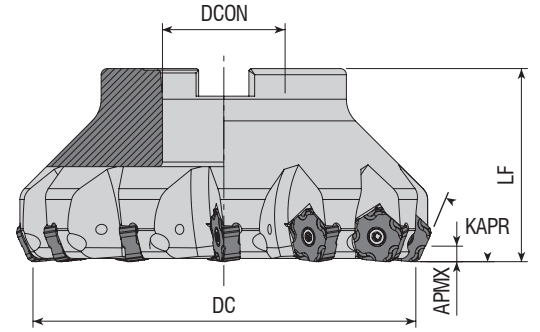

Takım Kodu Ordering Code Код для заказа	Stok Stock Наличие	Takım Ölçüleri (mm) Dimension (mm) Размеры (мм)					Kesici Uç Insert Пластина	Yedek Parçaları / Spare Parts / Запасные части		
		DC	ZEFP	DCON	LF	APMX		Sıkma Vidası Screw Зажимной винт	Tork Anahtar Torx Key Торх Ключ	Montaj Vidası Mounting Screw Монтажный винт
AFM67-PN1105-D050-A22-Z05	●	50	5	22	50	5	PNEG 1105..	4015-M4x11	80-T15	2508-M10x30
AFM67-PN1105-D063-A22-Z06	●	63	6	22	50	5				2510-M12x35
AFM67-PN1105-D080-A27-Z08	●	80	8	27	50	5				-
AFM67-PN1105-D100-B32-Z10	●	100	10	32	50	5				-
AFM67-PN1105-D125-B40-Z12	●	125	12	40	63	5				-
AFM67-PN1105-D160-C40-Z14	●	160	14	40	63	5				-

ZCC Ucuna Uygunudur. / Compatible with ZCC Insert. / Под пластину ZCC

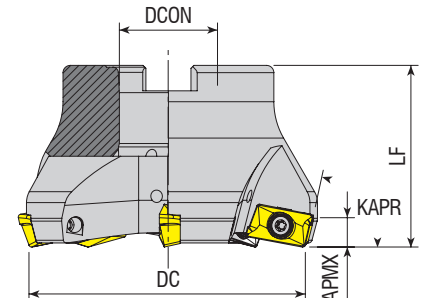

Takım Kodu Ordering Code Код для заказа	Stok Stock Наличие	Takım Ölçüleri (mm) Dimension (mm) Размеры (мм)					Kesici Uç Insert Пластина	Yedek Parçaları / Spare Parts / Запасные части		
		DC	ZEFP	DCON	LF	APMX		Sıkma Vidası Screw Зажимной винт	Tork Anahtar Torx Key Торх Ключ	Montaj Vidası Mounting Screw Монтажный винт
AFM75-AP16-D063-A22-Z04-H	●	63	4	22	40	6	AP. 1604..	4015-M4x11	80-T15	2508-M10x30
AFM75-AP16-D080-A27-Z05-H	●	80	5	27	50	6				2510-M12x35
AFM75-AP16-D100-A32-Z06-H	●	100	6	32	50	6				2514-M16x35
AFM75-AP16-D125-B40-Z07	●	125	7	40	63	6				-

ISO Ucuna Uygunudur. / Compatible with ISO Insert. / Под пластину ISO

R: Sağ / Right / Правый L: Sol / Left / Левый

● Stokta / In Stock / В наличии ○ Stokta Yok / Non Stock Item / Нет в наличии

Sipariş Örneği/Ordering Example/Образец заказа

1 ad./pcs./шт. AFM67-PN1105-D050-A22-Z05

Kesme Hesabı : S 377 / Cutting Calculation : P 377 / Расчет режимов резания: стр. 377

Montaj Ölçüleri : S 374 / Mounting Reference : P 374 / Инструкция по установке фрез: стр. 374

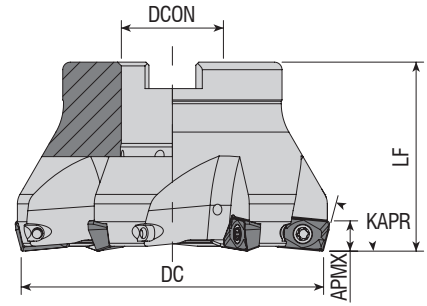

Takım Kodu Ordering Code Код для заказа	Stok Stock Наличие	Takım Ölçüleri (mm) Dimension (mm) Размеры (мм)					Kesici Uç Insert Пластина	Yedek Parçaları / Spare Parts / Запасные части		
		DC	ZEPF	DCON	LF	APMX		Sıkma Vidası Screw Зажимной винт	Tork Anahtar Torx Key Торх Ключ	Montaj Vidası Mounting Screw Монтажный винт
AFM75-X012-D050-A22-Z04-H	●	50	4	22	40	-	XO.. 1204..			
AFM75-X012-D063-A22-Z05-H	●	63	5	22	40	-				
AFM75-X012-D080-A27-Z06-H	●	80	6	27	50	-				

SC Ucuna Uygun. / Compatible with SC Insert. / Под пластину SC

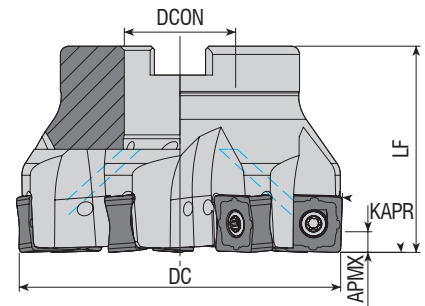

Takım Kodu Ordering Code Код для заказа	Stok Stock Наличие	Takım Ölçüleri (mm) Dimension (mm) Размеры (мм)					Kesici Uç Insert Пластина	Yedek Parçaları / Spare Parts / Запасные части		
		DC	ZEPF	DCON	LF	APMX		Sıkma Vidası Screw Зажимной винт	Tork Anahtar Torx Key Торх Ключ	Montaj Vidası Mounting Screw Монтажный винт
AFM88-SN1305-D050-A22-Z04	●	50	4	22	40	5	SNMU 1305..			
AFM88-SN1305-D050-A22-Z05	●	50	5	22	40	5				
AFM88-SN1305-D063-A22-Z05	●	63	5	22	40	5				
new AFM88L-SN1305-D063-A22-Z07	●	63	7	22	40	5				
AFM88-SN1305-D063-A22-Z07	●	63	7	22	40	5				
AFM88-SN1305-D080-A27-Z06	●	80	6	27	50	5				
AFM88-SN1305-D080-A27-Z09	●	80	9	27	50	5				
AFM88-SN1305-D100-A32-Z07	●	100	7	32	50	5				
AFM88-SN1305-D100-A32-Z11	●	100	11	32	50	5				
AFM88-SN1305-D125-B40-Z13	●	125	13	40	63	5				

R: Sağ / Right / Правый L: Sol / Left / Левый

● Stokta / In Stock / В наличии ○ Stokta Yok / Non Stock Item / Нет в наличии
KYCR Ucuna Uygun. / Compatible with KYCR Insert. / Под пластину KYCR

Sipariş Örneği/Ordering Example/Образец заказа

1 ad./pcs./шт. AFM75-X012-D050-A22-Z04-H

Kesme Hesabı : S 377 / Cutting Calculation : P 377 / Расчет режимов резания: стр. 377

Montaj Ölçüleri : S 374 / Mounting Reference : P 374 / Инструкция по установке фрез: стр. 374

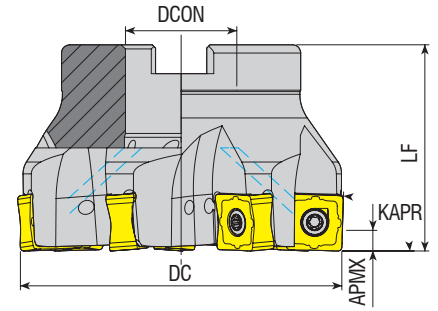

Takım Kodu Ordering Code Код для заказа	Stok Stock Наличие	Takım Ölçüleri (mm) Dimension (mm) Размеры (мм)					Kesici Uç Insert Пластина	Yedek Parçaları / Spare Parts / Запасные части			
		DC	ZEFP	DCON	LF	APMX		Sıkma Vidası Screw Зажимной винт	Tork Anahtar Torx Key Торх Ключ	Montaj Vidası Mounting Screw Монтажный винт	
AFM88-SN1306-D050-A22-Z05-H	●	50	5	22	40	12	SNGX 1306..				2508-M10x30
AFM88-SN1306-D063-A22-Z06-H	●	63	6	22	40	12					
AFM88-SN1306-D080-A27-Z07-H	●	80	7	27	50	12					

TGTC Ucuna Uygun. / Compatible with TGTC Insert. / Под пластину TGTC

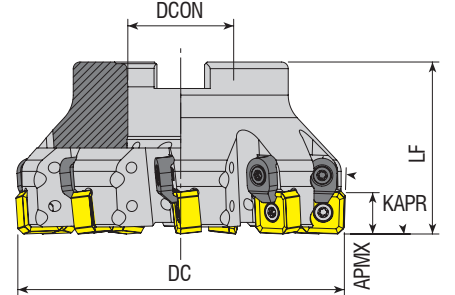
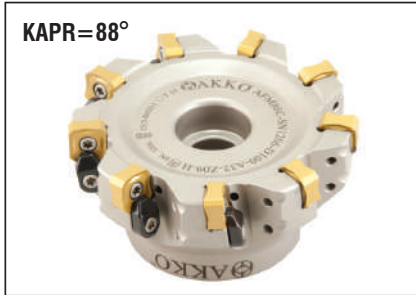

Takım Kodu Ordering Code Код для заказа	Stok Stock Наличие	Takım Ölçüleri (mm) Dimension (mm) Размеры (мм)					Kesici Uç Insert Пластина	Yedek Parçaları / Spare Parts / Запасные части								
		DC	ZEFP	DCON	LF	APMX		Sıkma Vidası Screw Зажимной винт	Baskı Parçası Wedge Clamp Прижим	Baskı Vidası Clamp Screw Зажимной винт	Tork Anahtar Torx Key Торх Ключ	Montaj Vidası Mounting Screw Монтажный винт				
new AFM88C-SN1206-D040-A16-Z04-H	●	40	4	16	40	11.5	SN.. 1206..						AKV-35-M8x34			
AFM88C-SN1206-D050-A22-Z05-H	●	50	5	22	40	11.5							4015-M4x11			
AFM88C-SN1206-D063-A22-Z06-H	●	63	6	22	40	11.5							4615-M4x11			
AFM88C-SN1206-D080-A27-Z07-H	●	80	7	27	50	11.5							ACK-05	4015-M4x11	80-T15	2508-M10x30
AFM88C-SN1206-D100-A32-Z09-H	●	100	9	32	52	11.5										2510-M12x35
new AFM88C-SN1206-D125-B40-Z10	●	125	10	40	63	11.5							1015-M4x11			

R: Sağ / Right / Правый L: Sol / Left / Левый
● Stokta / In Stock / В наличии ○ Stokta Yok / Non Stock Item / Нет в наличии
KRLY Ucuna Uygun. / Compatible with KRLY Insert. / Под пластину KRLY

Sipariş Örneği/Ordering Example/Образец заказа
1 ad./pcs./шт. AFM88-SN1306-D050-A22-Z05-H

Kesme Hesabı : S 377 / Cutting Calculation : P 377 / Расчет режимов резания: стр. 377
Montaj Ölçüleri : S 374 / Mounting Reference : P 374 / Инструкция по установке фрез: стр. 374

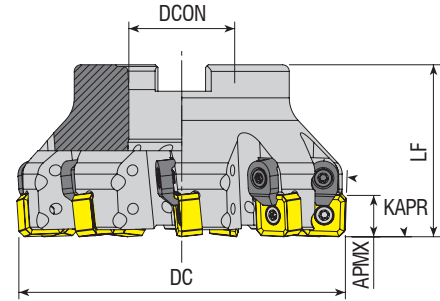
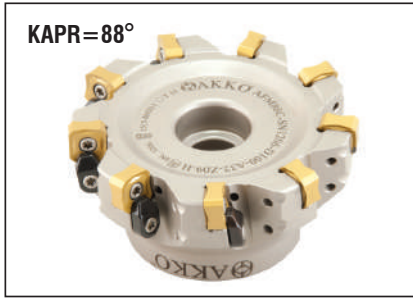

Takım Kodu Ordering Code Код для заказа	Stok Stock Наличие	Takım Ölçüleri (mm) Dimension (mm) Размеры (мм)					Kesici Uç Insert Пластина	Yedek Parçaları / Spare Parts / Запасные части				
		DC	ZEFP	DCON	LF	APMX		Sıkma Vidası Screw Зажимной винт	Baskı Parçası Wedge Clamp Прижим	Baskı Vidası Clamp Screw Зажимной винт	Tork Anahtar Torx Key Торх Ключ	Montaj Vidası Mounting Screw Монтажный винт
AFM88C-SN12..-D050-A22-Z05-H	●	50	5	22	40	11.5	SN.. 12..	1015-M4x11	ACK-05	4015-M4x11	80-T15	2508-M10x30 2510-M12x35 2514-M16x35
AFM88C-SN12..-D063-A22-Z06-H	●	63	6	22	40	11.5						
AFM88C-SN12..-D080-A27-Z07-H	●	80	7	27	50	11.5						
AFM88C-SN12..-D100-A32-Z09-H	●	100	9	32	52	11.5						

ISO Ucuna Uygundur. / Compatible with ISO Insert. / Под пластину ISO

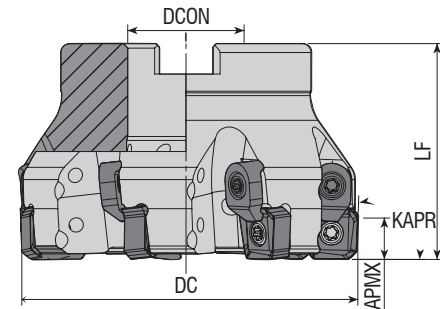



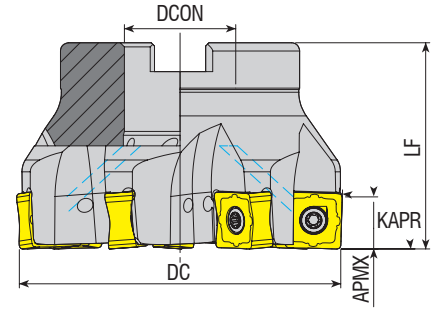

Takım Kodu Ordering Code Код для заказа	Stok Stock Наличие	Takım Ölçüleri (mm) Dimension (mm) Размеры (мм)					Kesici Uç Insert Пластина	Yedek Parçaları / Spare Parts / Запасные части				
		DC	ZEFP	DCON	LF	APMX		Sıkma Vidası Screw Зажимной винт	Baskı Parçası Wedge Clamp Прижим	Baskı Vidası Clamp Screw Зажимной винт	Tork Anahtar Torx Key Торх Ключ	Montaj Vidası Mounting Screw Монтажный винт
AFM88C-SN12Z-D063-A22-Z06-H	●	63	6	22	40	11.5	SNEG 1205..	4015-M4x11	ACK-05	4015-M4x11	80-T15	2508-M10x30 2510-M12x35
AFM88C-SN12Z-D080-A27-Z07-H	●	80	7	27	50	11.5						

R: Sağ / Right / Правый L: Sol / Left / Левый
● Stokta / In Stock / В наличии ○ Stokta Yok / Non Stock Item / Нет в наличии
ZCC Ucuna Uygundur. / Compatible with ZCC Insert. / Под пластину ZCC



Sipariş Örneği/Ordering Example/Образец заказа
1 ad./pcs./шт. AFM88C-SN12..-D050-A22-Z05-H
Kesme Hesabı : S 377 / Cutting Calculation : P 377 / Расчет режимов резания: стр. 377
Montaj Ölçüleri : S 374 / Mounting Reference : P 374 / Инструкция по установке фрез: стр. 374

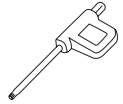
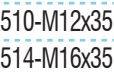
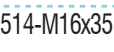

Takım Kodu Ordering Code Код для заказа	Stok Stock Наличие	Takım Ölçüleri (mm) Dimension (mm) Размеры (мм)					Kesici Uç Insert Пластина	Yedek Parçaları / Spare Parts / Запасные части					
		DC	ZEFP	DCON	LF	APMX		Sıkma Vidası Screw Зажимной винт	Baskı Parçası Wedge Clamp Грижим	Baskı Vidası Clamp Screw Зажимной винт	Tork Anahtar Torx Key Торх Ключ	Montaj Vidası Mounting Screw Монтажный винт	
AFM89-SN13051-D040-A16-Z04-H	●	40	4	16	40	10	 SNMU 1305..	 1015 M4x11	 -	 -	 80-T15	2306-M8x37	
AFM89-SN13051-D050-A22-Z05-H	●	50	5	22	40	10						2508-M10x30	
AFM89-SN13051-D063-A22-Z06-H	●	63	6	22	40	10						 2510-M12x35	
AFM89-SN13051-D063-A22-Z07-H	●	63	7	22	40	10							 2514-M16x35
AFM89-SN13051-D080-A27-Z08-H	●	80	8	27	50	10							
AFM89-SN13051-D100-A32-Z10-H	●	100	10	32	50	10							

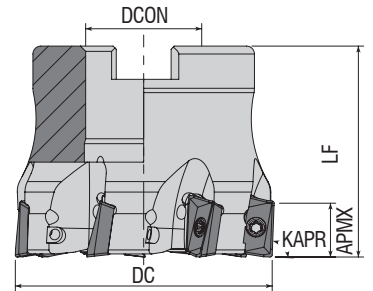
ISCR Ucuna Uygundur. / Compatible with ISCR Insert. / Под пластину ISCR



Takım Kodu Ordering Code Код для заказа	Stok Stock Наличие	Takım Ölçüleri (mm) Dimension (mm) Размеры (мм)					Kesici Uç Insert Пластина	Yedek Parçaları / Spare Parts / Запасные части		
		DC	ZEFP	DCON	LF	APMX		Sıkma Vidası Screw Зажимной винт	Tork Anahtar Torx Key Торх Ключ	Montaj Vidası Mounting Screw Монтажный винт
AFM90-AD10T3-D040-A16-Z06-H	●	40	6	16	40	10	 ADMT 10T3..	 3008-M2.5x6	 82-T08	2506-M8x30
AFM90-AD10T3-D050-A22-Z07-H	●	50	7	22	40	10				2508-M10x30

R: Sağ / Right / Правый L: Sol / Left / Левый

● Stokta / In Stock / В наличии ○ Stokta Yok / Non Stock Item / Нет в наличии
WLTR Ucuna Uygundur. / Compatible with WLTR Insert. / Под пластину WLTR

Sipariş Örneği/Ordering Example/Образец заказа
1 ad./pcs./шт. AFM89-SN13051-D040-A16-Z04-H

Kesme Hesabı : S 367 / Cutting Calculation : P 367 / Расчет режимов резания: стр. 367
Montaj Ölçüleri : S 364 / Mounting Reference : P 364 / Инструкция по установке фрез: стр. 364

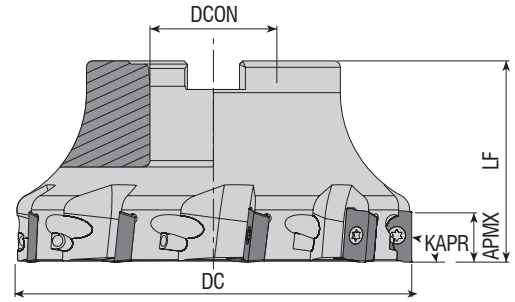

Takım Kodu Ordering Code Код для заказа	Stok Stock Наличие	Takım Ölçüleri (mm) Dimension (mm) Размеры (мм)					Kesici Uç Insert Пластина	Yedek Parçaları / Spare Parts / Запасные части			
		DC	ZEP	DCON	LF	APMX		Sikma Vidası Screw Зажимной винт	Tork Anahtar Torx Key Торх Ключ	Montaj Vidası Mounting Screw Монтажный винт	
AFM90-AD1505-D040-A16-Z04-H	●	40	4	16	40	14.3	AD.. 1505..	4015-M4x11	80-T15	2506-M8x30	
AFM90-AD1505-D050-A22-Z05-H	●	50	5	22	40	14.3					2508-M10x30
AFM90-AD1505-D063-A22-Z06-H	●	63	6	22	40	14.3					2510-M12x35
AFM90-AD1505-D080-A27-Z07-H	●	80	7	27	50	14.3					2514-M16x35
AFM90-AD1505-D100-A32-Z08-H	●	100	8	32	50	14.3					-
AFM90-AD1505-D125-B40-Z09	●	125	9	40	63	14.3					-

ISCR Ucuna Uygun. / Compatible with ISCR Insert. / Под пластину ISCR

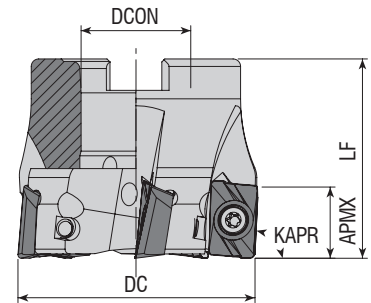

Takım Kodu Ordering Code Код для заказа	Stok Stock Наличие	Takım Ölçüleri (mm) Dimension (mm) Размеры (мм)					Kesici Uç Insert Пластина	Yedek Parçaları / Spare Parts / Запасные части			
		DC	ZEP	DCON	LF	APMX		Sikma Vidası Screw Зажимной винт	Tork Anahtar Torx Key Торх Ключ	Montaj Vidası Mounting Screw Монтажный винт	
AFM90-AD1505D-D050-A22-Z05-H	●	50	5	22	40	14.3	ADKT 150508	4015-M4x11	80-T15	2508-M10x30	
AFM90-AD1505D-D063-A27-Z06-H	●	63	6	27	50	14.3					2510-M12x35
AFM90-AD1505D-D080-A27-Z08-H	●	80	8	27	50	14.3					2514-M16x35
AFM90-AD1505D-D100-A32-Z08-H	●	100	8	32	50	14.3					-
AFM90-AD1505D-D125-B40-Z09	●	125	9	40	63	14.3					-

R: Sağ / Right / Правый L: Sol / Left / Левый

● Stokta / In Stock / В наличии ○ Stokta Yok / Non Stock Item / Нет в наличии

DJT Ucuna Uygun. / Compatible with DJT Insert. / Под пластину DJT

Sipariş Örneği/Ordering Example/Образец заказа

1 ad./pcs./шт. AFM90-AD1505-D040-A16-Z04-H

Kesme Hesabı : S 377 / Cutting Calculation : P 377 / Расчет режимов резания: стр. 377

Montaj Ölçüleri : S 374 / Mounting Reference : P 374 / Инструкция по установке фрез: стр. 374

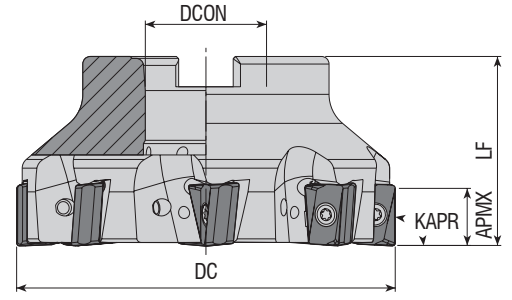

Takım Kodu Ordering Code Код для заказа	Stok Stock Наличие	Takım Ölçüleri (mm) Dimension (mm) Размеры (мм)					Kesici Uç Insert Пластина	Yedek Parçaları / Spare Parts / Запасные части		
		DC	ZEFP	DCON	LF	APMX		Sıkma Vidası Screw Зажимной винт	Tork Anahtar Torx Key Торх Ключ	Montaj Vidası Mounting Screw Монтажный винт
AFM90-AN11-D040-A16-Z04-H	●	40	4	16	40	11	ANGX 1105..	4010-M3x8	82-T10	2506-M8x30
AFM90-AN1506-D050-A22-Z04-H	●	50	4	22	40	14.5				ANGX 1506..
AFM90-AN1506-D063-A22-Z05-H	●	63	5	22	40	14.5	2510-M12x35			
AFM90-AN1506-D080-A27-Z06-H	●	80	6	27	50	14.5	2514-M16x35			
AFM90-AN1506-D100-A32-Z08-H	●	100	8	32	50	14.5	-			
AFM90-AN1506-D125-B40-Z09	●	125	9	40	63	14.5				
AFM90-AN1506-D160-C40-Z10	●	160	10	40	63	14.5				

ZCC Ucuna Uygunudur. / Compatible with ZCC Insert. / Под пластину ZCC

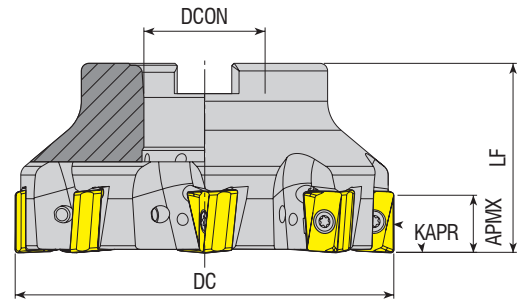

Takım Kodu Ordering Code Код для заказа	Stok Stock Наличие	Takım Ölçüleri (mm) Dimension (mm) Размеры (мм)					Kesici Uç Insert Пластина	Yedek Parçaları / Spare Parts / Запасные части		
		DC	ZEFP	DCON	LF	APMX		Sıkma Vidası Screw Зажимной винт	Tork Anahtar Torx Key Торх Ключ	Montaj Vidası Mounting Screw Монтажный винт
AFM90-AN1607-D050-A22-Z04-H	●	50	4	22	40	15	AN.X 1607..	4015-M4x11	80-T15	2508-M10x30
AFM90-AN1607-D063-A22-Z06-H	●	63	6	22	40	15				2510-M12x35
AFM90-AN1607-D080-A27-Z07-H	●	80	7	27	50	15				2514-M16x35
AFM90-AN1607-D100-A32-Z08-H	●	100	8	32	50	15				-
AFM90-AN1607-D125-B40-Z10	●	125	10	40	63	15				

R: Sağ / Right / Правый L: Sol / Left / Левый
● Stokta / In Stock / В наличии ○ Stokta Yok / Non Stock Item / Нет в наличии
TGTC Ucuna Uygunudur. / Compatible with TGTC Insert. / Под пластину TGTC

Sipariş Örneği/Ordering Example/Образец заказа
1 ad./pcs./шт. AFM90-AN11-D040-A16-Z04-H

Kesme Hesabı : S 377 / Cutting Calculation : P 377 / Расчет режимов резания: стр. 377
Montaj Ölçüleri : S 374 / Mounting Reference : P 374 / Инструкция по установке фрез: стр. 374

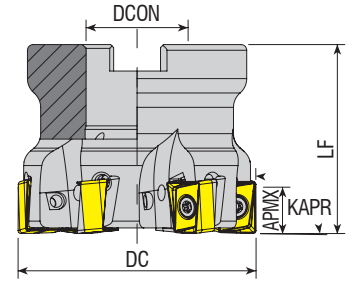

Takım Kodu Ordering Code Код для заказа	Stok Stock Наличие	Takım Ölçüleri (mm) Dimension (mm) Размеры (мм)					Kesici Uç Insert Пластина	Yedek Parçaları / Spare Parts / Запасные части		
		DC	ZEFP	DCON	LF	APMX		Sıkma Vidası Screw Зажимной винт	Tork Anahtar Torx Key Торх Ключ	Montaj Vidası Mounting Screw Монтажный винт
AFM90-AN12-D040-A16-Z04-H	●	40	4	16	40	12	ANKX 1205..	4015-M4x12	80-T15	2406-M8x30
AFM90-AN12-D050-A22-Z05-H	●	50	5	22	40	12				2508-M10x30
AFM90-AN12-D063-A27-Z06-H	●	63	6	27	50	12				2510-M12x35

ISCR Ucuna Uygunur. / Compatible with ISCR Insert. / Под пластину ISCR

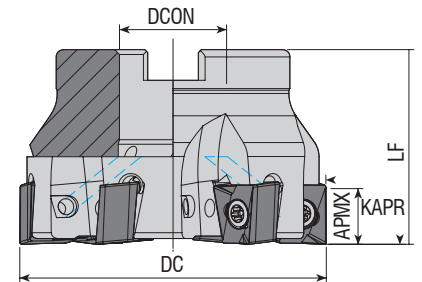

Takım Kodu Ordering Code Код для заказа	Stok Stock Наличие	Takım Ölçüleri (mm) Dimension (mm) Размеры (мм)					Kesici Uç Insert Пластина	Yedek Parçaları / Spare Parts / Запасные части		
		DC	ZEFP	DCON	LF	APMX		Sıkma Vidası Screw Зажимной винт	Tork Anahtar Torx Key Торх Ключ	Montaj Vidası Mounting Screw Монтажный винт
AFM90-AN1207-D040-A16-Z04-H	●	40	4	16	40	10	ANKX 1207..	4015-M4x11	80-T15	2506-M8x30
AFM90-AN1207-D050-A22-Z05-H	●	50	5	22	40	10				2508-M10x30
AFM90-AN1207-D063-A22-Z06-H	●	63	6	22	40	10				2510-M12x35
AFM90-AN1607X-D050-A22-Z04-H	●	50	4	22	40	15	ANKX 1607..	4015-M4x11	80-T15	2508-M10x30
AFM90-AN1607X-D063-A22-Z06-H	●	63	6	22	40	15				2510-M12x35
AFM90-AN1607X-D080-A27-Z07-H	●	80	7	27	50	15				2510-M12x35

R: Sağ / Right / Правый L: Sol / Left / Левый

● Stokta / In Stock / В наличии ○ Stokta Yok / Non Stock Item / Нет в наличии

XTC-GSC Ucuna Uygunur. / Compatible with XTC-GSC Insert. / Под пластину XTC-GSC

Sipariş Örneği/Ordering Example/Образец заказа

1 ad./pcs./шт. AFM90-AN12-D040-A16-Z04-H

Kesme Hesabı : S 377 / Cutting Calculation : P 377 / Расчет режимов резания: стр. 377

Montaj Ölçüleri : S 374 / Mounting Reference : P 374 / Инструкция по установке фрез: стр. 374

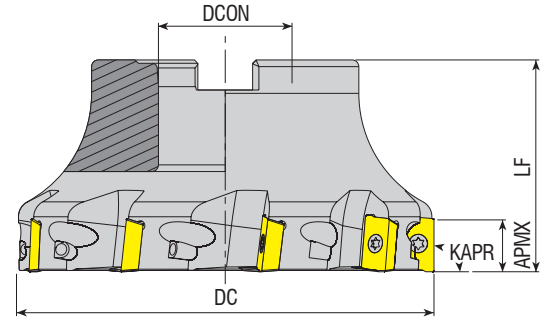

Takım Kodu Ordering Code Код для заказа	Stok Stock Наличие	Takım Ölçüleri (mm) Dimension (mm) Размеры (мм)					Kesici Uç Insert Пластина	Yedek Parçaları / Spare Parts / Запасные части		
		DC	ZEFP	DCON	LF	APMX		Sıkma Vidası Screw Зажимной винт	Tork Anahtar Torx Key Торх Ключ	Montaj Vidası Mounting Screw Монтажный винт
• new AFM90-AP10-D040-A16-Z04-H	●	40	4	16	35	10	AP. 1003.. ISO UCUNA UYGUNDUR. FOR ISO INSERT. Под пластину ISO	3008-M2.5x6	82-T08	2506-M8x30
AFM90-AP10-D040-A16-Z05-H	●	40	5	16	40	10				2508-M10x30
AFM90-AP10-D050-A22-Z06-H	●	50	6	22	40	10				3008-M2.5x6
• new AFM90-AP10-D050-A22-Z07-H	●	50	7	22	40	10				2508-M10x30
• new AFM90-AP10-D063-A22-Z06	●	63	6	22	40	10				3008-M2.5x6
AFM90-AP10-D063-A22-Z07-H	●	63	7	22	40	10				2508-M10x30
• new AFM90-AP10-D063-A22-Z09	●	63	9	22	40	10				3008-M2.5x6
AFM90-AP10-D080-A27-Z08-H	●	80	8	27	50	10				2510-M12x35
AFM90-AP10-D100-A32-Z09-H	●	100	9	32	50	10				2514-M16x35
AFM90-AP16-D040-A16-Z04-H	●	40	4	16	40	16				2506-M8x30
AFM90-AP16-D050-A22-Z05-H	●	50	5	22	40	16	AP. 1604.. ISO UCUNA UYGUNDUR. FOR ISO INSERT. Под пластину ISO	2508-M10x30		
AFM90-AP16-D052-A22-Z05-H	●	52	5	22	40	16				
AFM90-AP16-D063-A22-Z06-H	●	63	6	22	40	16				
AFM90-AP16-D080-A27-Z07-H	●	80	7	27	50	16				
AFM90-AP16-D100-A32-Z08-H	●	100	8	32	50	16				
AFM90-AP16-D125-B40-Z09	●	125	9	40	63	16				
AFM90-AP16-D160-C40-Z10	●	160	10	40	63	16				
AFM90-AP16-D200-C60-Z12	●	200	12	60	63	16				
AFM90-AP16DJ-D050-A22-Z05-H	●	50	5	22	40	16			2508-M10x30	
AFM90-AP16DJ-D063-A22-Z06-H	●	63	6	22	40	16			2510-M12x35	
AFM90-AP16DJ-D080-A27-Z07-H	●	80	7	27	50	16	AP. 1604.. LMN UCUNA UYGUNDUR. FOR LMN INSERT. Под пластину LMN	4015-M4x11	80-T15	
AFM90-AP16L-D050-A22-Z05-H	●	50	5	22	40	16				
AFM90-AP16L-D063-A22-Z06-H	●	63	6	22	40	16				
AFM90-AP16L-D080-A27-Z07-H	●	80	7	27	50	16				
AFM90-AP16P-D040-A16-Z04-H	●	40	4	16	40	16				
AFM90-AP16P-D050-A22-Z05-H	●	50	5	22	40	16				
AFM90-AP16P-D063-A22-Z06-H	●	63	6	22	40	16				
AFM90-AP16P-D080-A27-Z07-H	●	80	7	27	50	16				
AFM90-AP16P-D100-A32-Z08-H	●	100	8	32	50	16				
AFM90-AP16A-D050-A22-Z05-H	●	50	5	22	40	15				2508-M10x30
AFM90-AP16A-D063-A22-Z06-H	●	63	6	22	40	15	2510-M12x35			
AFM90-AP16A-D080-A27-Z07-H	●	80	7	27	50	15	2514-M16x35			
AFM90-AP16A-D100-A32-Z08-H	●	100	8	32	50	15	AP. 1604.. ACHTK UCUNA UYGUNDUR. FOR ACHTK INSERT. Под пластину ACHTK	-		
AFM90-AP16A-D125-B40-Z09	●	125	9	40	63	15				
AFM90-AP16Y-D040-A16-Z04-H	●	40	4	16	40	16				
AFM90-AP16Y-D050-A22-Z05-H	●	50	5	22	40	16				
AFM90-AP16Y-D063-A22-Z06-H	●	63	6	22	40	16				
AFM90-AP16Y-D080-A27-Z07-H	●	80	7	27	50	16				
AFM90-AP16Y-D100-A32-Z08-H	●	100	8	32	50	16				
AFM90-AP16Y-D040-A16-Z04-H	●	40	4	16	40	16			2506-M8x30	
AFM90-AP16Y-D050-A22-Z05-H	●	50	5	22	40	16			2508-M10x30	
AFM90-AP16Y-D063-A22-Z06-H	●	63	6	22	40	16			2510-M12x35	

R: Sağ / Right / Правый L: Sol / Left / Левый
● Stokta / In Stock / В наличии ○ Stokta Yok / Non Stock Item / Нет в наличии

Sipariş Örneği/Ordering Example/Образец заказа
1 ad./pcs./шт. AFM90-AP10-D040-A16-Z04-H

Kesme Hesabı : S 377 / Cutting Calculation : P 377 / Расчет режимов резания: стр. 377
Montaj Ölçüleri : S 374 / Mounting Reference : P 374 / Инструкция по установке фрез: стр. 374

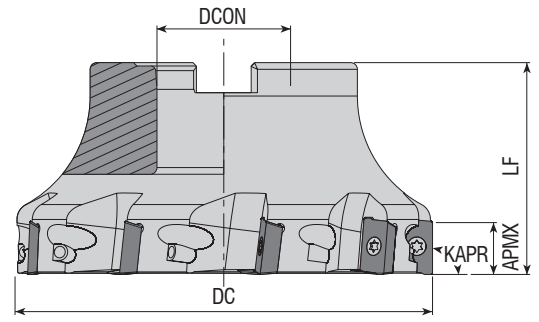
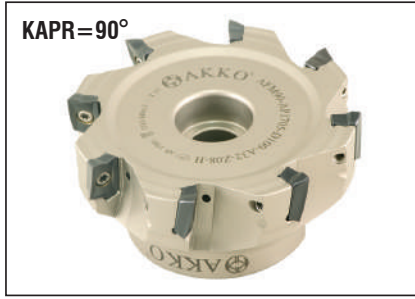

Takım Kodu Ordering Code Код для заказа	Stok Stock Наличие	Takım Ölçüleri (mm) Dimension (mm) Размеры (мм)					Kesici Uç Insert Пластина	Yedek Parçaları / Spare Parts / Запасные части		
		DC	ZEFP	DCON	LF	APMX		Sikma Vidası Screw Зажимной винт	Tork Anahtar Torx Key Торх Ключ	Montaj Vidası Mounting Screw Монтажный винт
AFM90-AP1705-D050-A22-Z05-H	●	50	5	22	40	16	AP. 1705..	4015-M4x11	80-T15	2508-M10x30
AFM90-AP1705-D063-A22-Z06-H	●	63	6	22	40	16				
AFM90-AP1705-D080-A27-Z07-H	●	80	7	27	50	16				
AFM90-AP1705-D100-A32-Z08-H	●	100	8	32	50	16				

TGTC Ucuna Uygun. / Compatible with TGTC Insert. / Под пластину TGTC

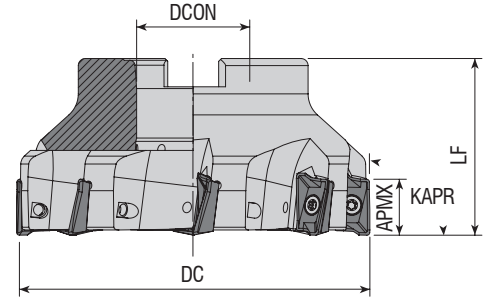

Takım Kodu Ordering Code Код для заказа	Stok Stock Наличие	Takım Ölçüleri (mm) Dimension (mm) Размеры (мм)					Kesici Uç Insert Пластина	Yedek Parçaları / Spare Parts / Запасные части		
		DC	ZEFP	DCON	LF	APMX		Sikma Vidası Screw Зажимной винт	Tork Anahtar Torx Key Торх Ключ	Montaj Vidası Mounting Screw Монтажный винт
AFM90-AX1235-D040-A16-Z06-H	●	40	6	16	40	10	AX.T 1235..	3108-M3x6	82-T08	2506-M8x30
AFM90-AX1235-D050-A22-Z07-H	●	50	7	22	40	10				2508-M10x30
AFM90-AX1235-D063-A22-Z08-H	●	63	8	22	40	10				2510-M12x35
AFM90-AX1235-D080-A27-Z10-H	●	80	10	27	50	10				2506-M8x30
AFM90-AX1705-D040-A16-Z04-H	●	40	4	16	40	14	AX.T 1705..	4015-M4x11	80-T15	2508-M10x30
AFM90-AX1705-D050-A22-Z05-H	●	50	5	22	40	14				2510-M12x35
AFM90-AX1705-D063-A22-Z06-H	●	63	6	22	40	14				2514-M16x35
AFM90-AX1705-D080-A27-Z07-H	●	80	7	27	50	14				2506-M8x30
AFM90-AX1705-D100-A32-Z08-H	●	100	8	32	50	14				2514-M16x35

R: Sağ / Right / Правый L: Sol / Left / Левый

● Stokta / In Stock / В наличии ○ Stokta Yok / Non Stock Item / Нет в наличии

SMTM Ucuna Uygun. / Compatible with SMTM Insert. / Под пластину SMTM

Sipariş Örneği/Ordering Example/Образец заказа

1 ad./pcs./шт. AFM90-AP1705-D050-A22-Z05-H

Kesme Hesabı : S 377 / Cutting Calculation : P 377 / Расчет режимов резания: стр. 379

Montaj Ölçüleri : S 374 / Mounting Reference : P 374 / Инструкция по установке фрез: стр. 374

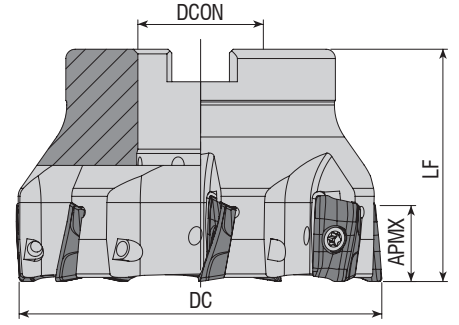
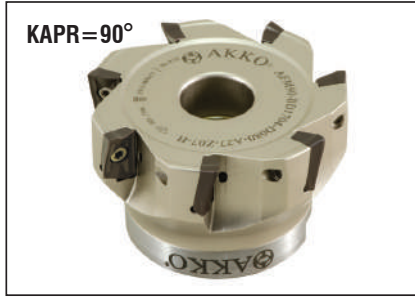

Takım Kodu Ordering Code Код для заказа	Stok Stock Наличие	Takım Ölçüleri (mm) Dimension (mm) Размеры (мм)					Kesici Uç Insert Пластина	Yedek Parçaları / Spare Parts / Запасные части		
		DC	ZEFP	DCON	LF	APMX		Sıkma Vidası Screw Зажимной винт	Tork Anahtar Torx Key Торх Ключ	Montaj Vidası Mounting Screw Монтажный винт
AFM90-BD11T3-D040-A16-Z04-H	●	40	4	16	40	10	BDMT 11T3..	3008-M2.5x6	82-T08	2506-M8x30
AFM90-BD11T3-D040-A16-Z05-H	●	40	5	16	40	10				
AFM90-BD11T3-D050-A22-Z05-H	●	50	5	22	40	10				
AFM90-BD11T3-D063-A22-Z06-H	●	63	6	22	40	10				
AFM90-BD1704-D050-A22-Z04-H	●	50	4	22	40	15.7	BDMT 1704..	4015-M4x11	80-T15	2508-M10x30
AFM90-BD1704-D050-A22-Z05-H	●	50	5	22	40	15.7				
AFM90-BD1704-D063-A22-Z06-H	●	63	6	22	40	15.7				
AFM90-BD1704-D080-A27-Z06-H	●	80	6	27	50	15.7				
AFM90-BD1704-D080-A27-Z07-H	●	80	7	27	50	15.7				
AFM90-BD1704-D100-A32-Z07-H	●	100	7	32	50	15.7				

KYCR Ucuna Uygundur. / Compatible with KYCR Insert. / Под пластину KYCR

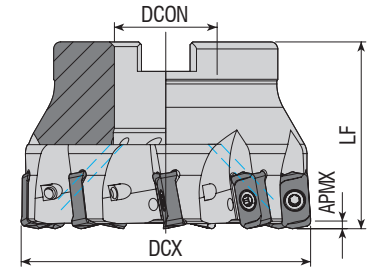

Takım Kodu Ordering Code Код для заказа	Stok Stock Наличие	Takım Ölçüleri (mm) Dimension (mm) Размеры (мм)					Kesici Uç Insert Пластина	Yedek Parçaları / Spare Parts / Запасные части		
		DC	ZEFP	DCON	LF	APMX		Sıkma Vidası Screw Зажимной винт	Tork Anahtar Torx Key Торх Ключ	Montaj Vidası Mounting Screw Монтажный винт
AFM90-LO1004-D040-A16-Z05-H	●	40	5	16	40	10	LOMU 1004..	1108-M3x6.8	82-T08	2506-M8x30
AFM90-LO1004-D050-A22-Z05-H	●	50	5	22	40	10				
AFM90-LO1004-D063-A22-Z06-H	●	63	6	22	40	10				
AFM90-LO1505-D050-A22-Z04-H	●	50	4	22	40	15	LOMU 1505..	3015-M4x11	80-T15	2508-M10x30
AFM90-LO1505-D063-A22-Z05-H	●	63	5	22	40	15				

R: Sağ / Right / Правый L: Sol / Left / Левый
● Stokta / In Stock / В наличии ○ Stokta Yok / Non Stock Item / Нет в наличии
KYCR Ucuna Uygundur. / Compatible with KYCR Insert. / Под пластину KYCR.

Sipariş Örneği/Ordering Example/Образец заказа
1 ad./pcs./шт. AFM90-BD11T3-D040-A16-Z04-H
Kesme Hesabı : S 377 / Cutting Calculation : P 377 / Расчет режимов резания: стр. 377
Montaj Ölçüleri : S 374 / Mounting Reference : P 374 / Инструкция по установке фрез: стр. 374

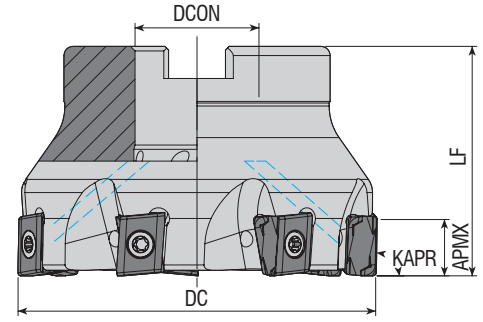

Takım Kodu Ordering Code Код для заказа	Stok Stock Наличие	Takım Ölçüleri (mm) Dimension (mm) Размеры (мм)					Kesici Uç Insert Пластина	Yedek Parçaları / Spare Parts / Запасные части		
		DC	ZEFP	DCON	LF	APMX		Sıkma Vidası Screw Зажимной винт	Tork Anahtar Torx Key Торх Ключ	Montaj Vidası Mounting Screw Монтажный винт
AFM90-LN1506X-D063-A22-Z06	●	63	6	22	40	7	LNMT 1506..	3015-M4x11	80-T15	2508-M10x30
AFM90-LN1506X-D080-A27-Z07	●	80	7	27	50	7				2510-M12x35
AFM90-LN1506X-D100-A32-Z08	●	100	8	32	50	7				2514-M16x35

R: Sağ / Right / Правый L: Sol / Left / Левый

● Stokta / In Stock / В наличии ○ Stokta Yok / Non Stock Item / Нет в наличии

XTC-GSC Ucuna Uygunudur. / Compatible with XTC-GSC Insert. / Под пластину XTC-GSC

Kesme Hesabı : S 377 / Cutting Calculation : P 377 / Расчет режимов резания: стр. 377

Montaj Ölçüleri : S 374 / Mounting Reference : P 374 / Инструкция по установке фрез: стр. 374

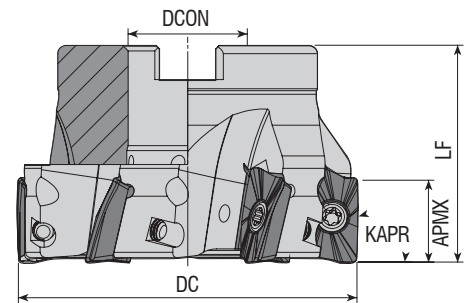

Takım Kodu Ordering Code Код для заказа	Stok Stock Наличие	Takım Ölçüleri (mm) Dimension (mm) Размеры (мм)					Kesici Uç Insert Пластина	Yedek Parçaları / Spare Parts / Запасные части					
		DC	ZEFP	DCON	LF	APMX		Sıkma Vidası Screw Зажимной винт	Tork Anahtar Torx Key Торх Ключ	Montaj Vidası Mounting Screw Монтажный винт			
AFM90-A01236-D050-A22-Z05-H	●	50	5	22	40	10	AO.. 1236..	3008-M2.5x6	82-T08	2508-M10x30			
AFM90-A01848-D050-A22-Z05-H	●	50	5	22	40	15					AO.. 1848..	4015-M4x11	80-T15
AFM90-A01848-D063-A22-Z06-H	●	63	6	22	40	15							

MTSBH Ucuna Uygunudur. / Compatible with MTSBH Insert. / Под пластину MTSBH

Sipariş Örneği/Ordering Example/Образец заказа
1 ad./pcs./шт. AFM90-LN1506X-D063-A22-Z06

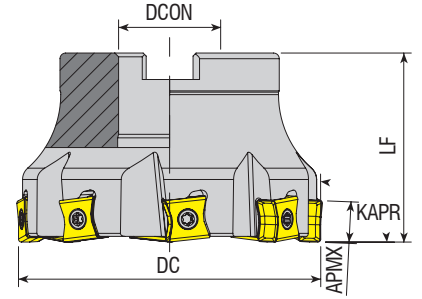

Takım Kodu Ordering Code Код для заказа	Stok Stock Наличие	Takım Ölçüleri (mm) Dimension (mm) Размеры (мм)					Kesici Uç Insert Пластина	Yedek Parçaları / Spare Parts / Запасные части		
		DC	ZEFP	DCON	LF	APMX		Sıkma Vidası Screw Зажимной винт	Tork Anahtar Torx Key Торх Ключ	Montaj Vidası Mounting Screw Монтажный винт
AFM90-LN1106-D050-A22-Z05	●	50	5	22	40	10	LNMT 1106..	4015-M3.5x11	80-T15	2508-M10x30
AFM90-LN1106-D063-A22-Z06	●	63	6	22	40	10				2510-M12x35
AFM90-LN1106-D080-A27-Z08	●	80	8	27	50	10				2514-M16x35
AFM90L-LN1106-D080-A27-Z08	●	80	8	27	50	10				-
AFM90-LN1106-D100-A32-Z09	●	100	9	32	50	10				2506-M8x30
AFM90L-LN1106-D100-A32-Z09	●	100	9	32	50	10				2508-M10x30
AFM90-LN1106-D125-B40-Z10	●	125	10	40	63	10				2510-M12x35
AFM90-LN1306-D040-A16-Z04-H	●	40	4	16	40	12.5	T490 LNMT 1306..	4015-M4x11	80-T15	2514-M16x35
AFM90-LN1306-D050-A22-Z05-H	●	50	5	22	40	12.5				2506-M8x30
AFM90-LN1306-D063-A22-Z06-H	●	63	6	22	40	12.5				2508-M10x30
AFM90-LN1306-D080-A27-Z07-H	●	80	7	27	50	12.5				2510-M12x35
AFM90-LN1306-D100-A32-Z08-H	●	100	8	32	50	12.5				2514-M16x35
AFM90L-LN1506-D040-A16-Z04	●	40	4	16	40	14	LNMT 1506..	4015-M4x11	80-T20	2506-M8x30
AFM90-LN1506-D040-A16-Z04	○	40	4	16	40	14				2508-M10x30
AFM90-LN1506-D050-A22-Z05	○	50	5	22	40	14				2510-M12x35
AFM90-LN1506-D063-A22-Z06	○	63	6	22	40	14				2514-M16x35
AFM90-LN1506-D080-A27-Z07	○	80	7	27	50	14				
AFM90-LN1607-D050-A22-Z03-H	●	50	3	22	40	16	T490 LNHT 1607..	4420-M5x14	80-T20	2508-M10x30
AFM90-LN1607-D063-A22-Z04-H	○	63	4	22	40	16				2510-M12x35
AFM90-LN1607-D080-A27-Z05-H	●	80	5	27	50	16				2514-M16x35
AFM90-LN1607-D100-A32-Z06-H	●	100	6	32	50	16				

R: Sağ / Right / Правый L: Sol / Left / Левый
● Stokta / In Stock / В наличии ○ Stokta Yok / Non Stock Item / Нет в наличии
ISCR Ucuna Uygunudur. / Compatible with ISCR Insert. / Под пластину ISCR

Sipariş Örneği/Ordering Example/Образец заказа
1 ad./pcs./шт. AFM90-LN1106-D050-A22-Z05

Kesme Hesabı : S 377 / Cutting Calculation : P 377 / Расчет режимов резания: стр. 377
Montaj Ölçüleri : S 374 / Mounting Reference : P 374 / Инструкция по установке фрез: стр. 374

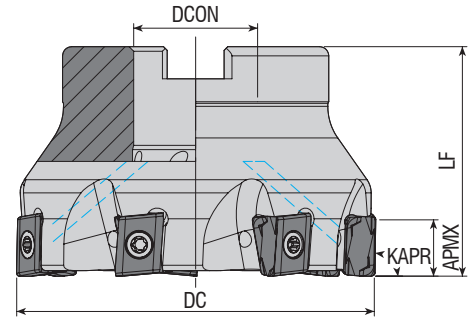

Takım Kodu Ordering Code Код для заказа	Stok Stock Наличие	Takım Ölçüleri (mm) Dimension (mm) Размеры (мм)					Kesici Uç Insert Пластина	Yedek Parçaları / Spare Parts / Запасные части			
		DC	ZEFP	DCON	LF	APMX		Sıkma Vidası Screw Зажимной винт	Tork Anahtar Torx Key Торх Ключ	Montaj Vidası Mounting Screw Монтажный винт	
new AFM90-LN1306W-D040-A16-Z04-H	●	40	4	16	40	12	LNHU 1306..	4115-M4x12	80-T15	2506-M8x30	
AFM90-LN1306W-D050-A22-Z05-H	●	50	5	22	40	12				2508-M10x30	
AFM90-LN1306W-D063-A22-Z06-H	●	63	6	22	40	12				2510-M12x35	
AFM90-LN1306W-D080-A27-Z07-H	●	80	7	27	50	12				2514-M16x35	
new AFM90-LN1306W-D100-A32-Z08-H	●	100	8	32	50	12					

WLTR Ucuna Uygunur. / Compatible with WLTR Insert. / Под пластину WLTR

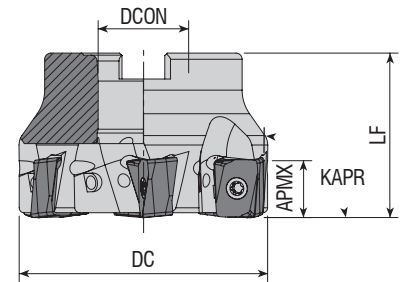

Takım Kodu Ordering Code Код для заказа	Stok Stock Наличие	Takım Ölçüleri (mm) Dimension (mm) Размеры (мм)					Kesici Uç Insert Пластина	Yedek Parçaları / Spare Parts / Запасные части			
		DC	ZEFP	DCON	LF	APMX		Sıkma Vidası Screw Зажимной винт	Tork Anahtar Torx Key Торх Ключ	Montaj Vidası Mounting Screw Монтажный винт	
AFM90-LN1307-D050-A22-Z04-H	●	50	4	22	40	13	LNGX 1307..	1315-M4x11	80-T15	2508-M10x30	
AFM90-LN1307-D063-A22-Z06-H	●	63	6	22	40	13				2510-M12x35	
AFM90-LN1307-D080-A27-Z07-H	●	80	7	27	50	13				2514-M16x35	
AFM90-LN1307-D100-A32-Z08-H	●	100	8	32	50	13					

R: Sağ / Right / Правый L: Sol / Left / Левый

● Stokta / In Stock / В наличии ○ Stokta Yok / Non Stock Item / Нет в наличии

WLTR Ucuna Uygunur. / Compatible with WLTR Insert. / Под пластину WLTR

Sipariş Örneği/Ordering Example/Образец заказа

1 ad./pcs./шт. AFM90-LN1306W-D040-A16-Z04-H

Kesme Hesabı : S 367 / Cutting Calculation : P 367 / Расчет режимов резания: стр. 367

Montaj Ölçüleri : S 364 / Mounting Reference : P 364 / Инструкция по установке фрез: стр. 364

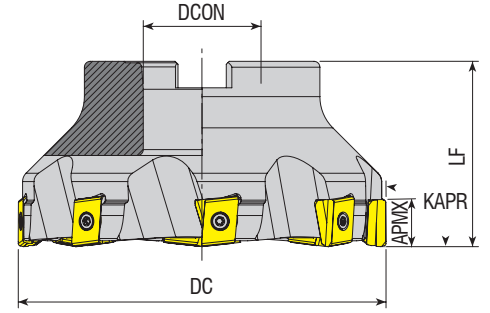

Takım Kodu Ordering Code Код для заказа	Stok Stock Наличие	Takım Ölçüleri (mm) Dimension (mm) Размеры (мм)					Kesici Uç Insert Пластина	Yedek Parçaları / Spare Parts / Запасные части		
		DC	ZEFP	DCON	LF	APMX		Sıkma Vidası Screw Зажимной винт	Tork Anahtar Torx Key Торх Ключ	Montaj Vidası Mounting Screw Монтажный винт
AFM90-LN15Z-D050-A22-Z04	●	50	4	22	40	15	LNKT 1506..	4015-M4x11	80-T15	2508-M10x30
AFM90-LN15Z-D063-A22-Z05	●	63	5	22	40	15				2510-M12x35
AFM90-LN15Z-D080-A27-Z06	●	80	6	27	50	15				2514-M16x35
AFM90-LN15Z-D100-A32-Z07	●	100	7	32	50	15				-
AFM90-LN15Z-D125-B40-Z08	●	125	8	40	63	15				-

ZCC Ucuna Uygunudur. / Compatible with ZCC Insert. / Под пластину ZCC

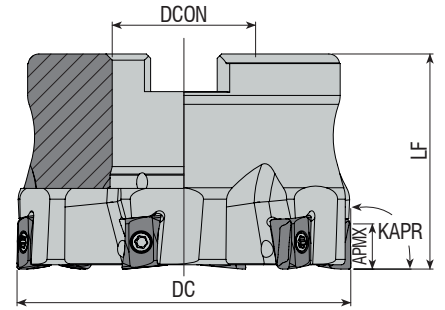

Takım Kodu Ordering Code Код для заказа	Stok Stock Наличие	Takım Ölçüleri (mm) Dimension (mm) Размеры (мм)					Kesici Uç Insert Пластина	Yedek Parçaları / Spare Parts / Запасные части		
		DC	ZEFP	DCON	LF	APMX		Sıkma Vidası Screw Зажимной винт	Tork Anahtar Torx Key Торх Ключ	Montaj Vidası Mounting Screw Монтажный винт
AFM90-L008-D040-A16-Z06-H	●	40	6	16	40	2	LOEX 0804..	3008-M2.5x8	82-T08	2506-M8x30
AFM90-L008-D050-A22-Z07-H	●	50	7	22	40	2				2508-M10x30
AFM90-L008-D063-A27-Z06-H	●	63	6	27	40	2				2510-M12x35

R: Sağ / Right / Правый L: Sol / Left / Левый

● Stokta / In Stock / В наличии ○ Stokta Yok / Non Stock Item / Нет в наличии

SC Ucuna Uygunudur. / Compatible with SC Insert. / Под пластину SC

Sipariş Örneği/Ordering Example/Образец заказа

1 ad./pcs./шт. AFM90-LN15Z-D050-A22-Z04

Kesme Hesabı : S 367 / Cutting Calculation : P 367 / Расчет режимов резания: стр. 367

Montaj Ölçüleri : S 364 / Mounting Reference : P 364 / Инструкция по установке фрез: стр. 364

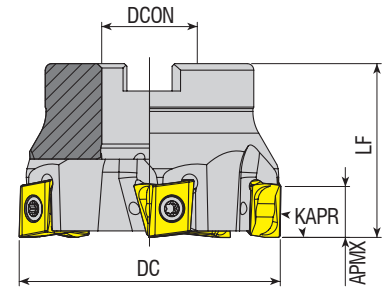

Takım Kodu Ordering Code Код для заказа	Stok Stock Наличие	Takım Ölçüleri (mm) Dimension (mm) Размеры (мм)					Kesici Uç Insert Пластина	Yedek Parçaları / Spare Parts / Запасные части		
		DC	ZEP	DCON	LF	APMX		Sıkma Vidası Screw Зажимной винт	Tork Anahtar Torx Key Торх Ключ	Montaj Vidası Mounting Screw Монтажный винт
new AFM90-L00904-D040-A16-Z06-H	●	40	6	16	40	8	LOGU 0904..	3007-M2.7x8	82-T07	2506-M8x30
new AFM90-L00904-D050-A22-Z05-H	●	50	5	22	40	8				2508-M10x30
new AFM90-L00904-D050-A22-Z07-H	●	50	7	22	40	8				
new AFM90-L00904-D063-A22-Z06-H	●	63	6	22	40	8	LOGU 1207..	3015-M4x11	80-T15	2506-M8x30
AFM90-L01207-D040-A16-Z04-H	●	40	4	16	40	11				2508-M10x30
AFM90-L01207-D050-A22-Z05-H	●	50	5	22	40	11				
AFM90-L01207-D063-A22-Z05-H	●	63	5	22	40	11				
new AFM90-L01207-D063-A22-Z06-H	●	63	6	22	40	11				
new AFM90-L01207-D080-A27-Z07-H	○	80	7	27	50	11				2510-M12x35
new AFM90-L01207-D100-A32-Z07-H	●	100	7	32	50	11				2514-M16x35

MTSBH Ucuna Uygun. / Compatible with MTSBH Insert. / Под пластину MTSBH.

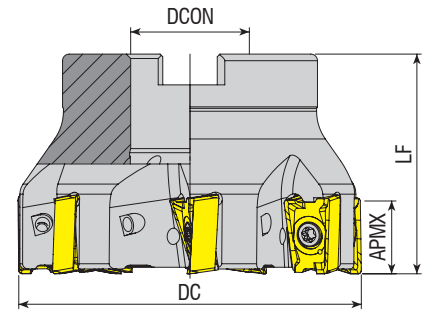

Takım Kodu Ordering Code Код для заказа	Stok Stock Наличие	Takım Ölçüleri (mm) Dimension (mm) Размеры (мм)					Kesici Uç Insert Пластина	Yedek Parçaları / Spare Parts / Запасные части		
		DC	ZEP	DCON	LF	APMX		Sıkma Vidası Screw Зажимной винт	Tork Anahtar Torx Key Торх Ключ	Montaj Vidası Mounting Screw Монтажный винт
AFM90-LN15T6-D050-A22-Z05-H	●	50	5	22	40	15.5	LNGU 15T6..	4015-M4x12	80-T15	2508-M10x30
AFM90-LN15T6-D063-A22-Z06-H	●	63	6	22	40	15.5				2510-M12x35
AFM90-LN15T6-D080-A27-Z07-H	●	80	7	27	50	15.5				

R: Sağ / Right / Правый L: Sol / Left / Левый

● Stokta / In Stock / В наличии ○ Stokta Yok / Non Stock Item / Нет в наличии

KNMTL Ucuna Uygun. / Compatible with KNMTL Insert. / Под пластину KNMTL.

Sipariş Örneği/Ordering Example/Образец заказа

1 ad./pcs./шт. AFM90-L00904-D040-A16-Z06-H

Kesme Hesabı : S 377 / Cutting Calculation : P 377 / Расчет режимов резания: стр. 377

Montaj Ölçüleri : S 374 / Mounting Reference : P 374 / Инструкция по установке фрез: стр. 374

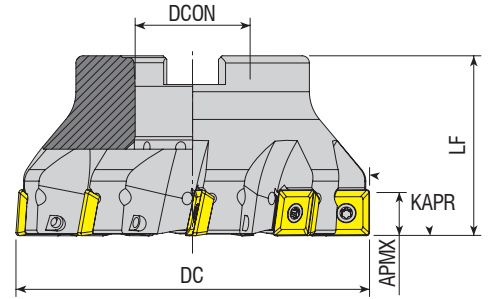

Takım Kodu Ordering Code Код для заказа	Stok Stock Наличие	Takım Ölçüleri (mm) Dimension (mm) Размеры (мм)					Kesici Uç Insert Пластина	Yedek Parçaları / Spare Parts / Запасные части		
		DC	ZEFP	DCON	LF	APMX		Sıkma Vidası Screw Зажимной винт	Tork Anahtar Torx Key Торх Ключ	Montaj Vidası Mounting Screw Монтажный винт
AFM90-R290.12-D050-A22-Z04-H	●	50	4	22	40	10.7	R290-12T3..			
AFM90-R290.12-D063-A22-Z05-H	●	63	5	22	40	10.7				
AFM90-R290.12-D080-A27-Z07-H	●	80	7	27	50	10.7				
AFM90-R290.12-D100-A32-Z09-H	●	100	9	32	50	10.7				
AFM90-R290.12-D125-B40-Z11	●	125	11	40	63	10.7				
										2508-M10x30
										2510-M12x35
										2514-M16x35
										-

SNDVK Ucuna Uygundur. / Compatible with SNDVK Insert. / Под пластину SNDVK

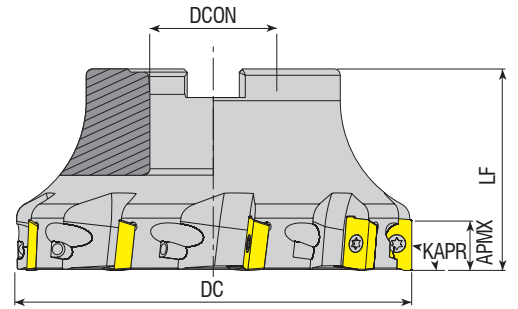

Takım Kodu Ordering Code Код для заказа	Stok Stock Наличие	Takım Ölçüleri (mm) Dimension (mm) Размеры (мм)					Kesici Uç Insert Пластина	Yedek Parçaları / Spare Parts / Запасные части		
		DC	ZEFP	DCON	LF	APMX		Sıkma Vidası Screw Зажимной винт	Tork Anahtar Torx Key Торх Ключ	Montaj Vidası Mounting Screw Монтажный винт
AFM90-R390.11-D040-A16-Z05-H	●	40	5	16	40	10	R390-11T3..			
AFM90-R390.11-D050-A22-Z06-H	●	50	6	22	40	10				
AFM90-R390.11-D063-A22-Z07-H	●	63	7	22	40	10				
AFM90-R390.11-D080-A27-Z09-H	●	80	9	27	50	10	R390-1704..			
AFM90-R390.17-D040-A16-Z04-H	●	40	4	16	40	15.4				
AFM90-R390.17-D050-A22-Z05-H	●	50	5	22	40	15.4				
AFM90-R390.17-D063-A22-Z06-H	●	63	6	22	40	15.4				
AFM90-R390.17-D080-A27-Z07-H	●	80	7	27	50	15.4				
AFM90-R390.17-D100-A32-Z08-H	●	100	8	32	50	15.4				
AFM90-R390.17-D125-B40-Z09	●	125	9	40	63	15.4				
AFM90-R390.18-D050-A22-Z04-H	●	50	4	22	40	15.4				
AFM90-R390.18-D063-A22-Z05-H	●	63	5	22	40	15.4				
AFM90-R390.18-D080-A27-Z06-H	●	80	6	27	50	15.4				
AFM90-R390.18-D100-A32-Z07-H	●	100	7	32	50	15.4	R390-1806..			
AFM90-R390.18-D125-B40-Z08	●	125	8	40	63	15.4				
										2506-M8x30
										2508-M10x30
										2510-M12x35
										2506-M8x30
										2508-M10x30
										2510-M12x35
										2514-M16x35
										-
										2508-M10x30
										2510-M12x35
										2514-M16x35
										-

R: Sağ / Right / Правый L: Sol / Left / Левый

● Stokta / In Stock / В наличии ○ Stokta Yok / Non Stock Item / Нет в наличии

SNDVK Ucuna Uygundur. / Compatible with SNDVK Insert. / Под пластину SNDVK

Sipariş Örneği/Ordering Example/Образец заказа

1 ad./pcs./шт. AFM90-R290.12-D050-A22-Z04-H

Kesme Hesabı : S 377 / Cutting Calculation : P 377 / Расчет режимов резания: стр. 377

Montaj Ölçüleri : S 374 / Mounting Reference : P 374 / Инструкция по установке фрез: стр. 374

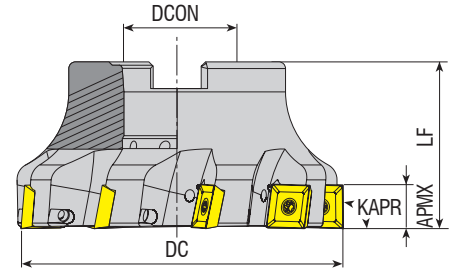
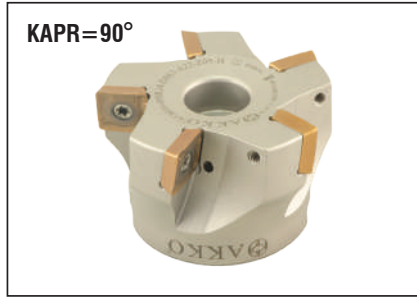

Takım Kodu Ordering Code Код для заказа	Stok Stock Наличие	Takım Ölçüleri (mm) Dimension (mm) Размеры (мм)					Kesici Uç Insert Пластина	Yedek Parçaları / Spare Parts / Запасные части		
		DC	ZEFP	DCON	LF	APMX		Sıkma Vidası Screw Зажимной винт	Tork Anahtar Torx Key Торкс Ключ	Montaj Vidası Mounting Screw Монтажный винт
AFM90-490R08-D063-A22-Z06-H	●	63	6	22	40	5.5	490R-08T3..	3008-M2.5x6	82-T08	2508-M10x30
AFM90-490R14-D050-A22-Z04-H	●	50	4	22	40	10				
AFM90-490R14-D063-A22-Z05-H	●	63	5	22	40	10	490R-1404..	4015-M3.5x11	80-T15	2510-M12x35 2514-M16x35
AFM90-490R14-D080-A27-Z07-H	●	80	7	27	50	10				
AFM90-490R14-D100-A32-Z07-H	●	100	7	32	50	10				
AFM90-490R14-D125-B40-Z08	●	125	8	40	63	10				
new AFM90-490R14-D125-B40-Z12	●	125	12	40	63	10				
AFM90-490R14-D160-C40-Z12	●	160	12	40	63	10				
AFM90-490R14-D200-C60-Z16	●	200	16	60	63	10				

SNDVK Ucuna Uygunur. / Compatible with SNDVK Insert. / Под пластину SNDVK

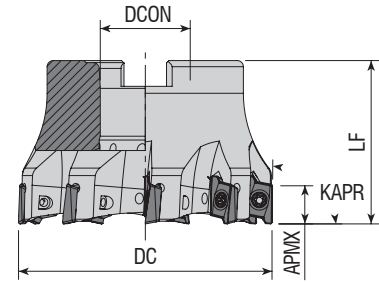

Takım Kodu Ordering Code Код для заказа	Stok Stock Наличие	Takım Ölçüleri (mm) Dimension (mm) Размеры (мм)					Kesici Uç Insert Пластина	Yedek Parçaları / Spare Parts / Запасные части		
		DC	ZEFP	DCON	LF	APMX		Sıkma Vidası Screw Зажимной винт	Tork Anahtar Torx Key Торкс Ключ	Montaj Vidası Mounting Screw Монтажный винт
AFM90-RT10-D040-A16-Z06-H	●	40	6	16	40	10	RT 1003	3008-M2.5x6	82-T08	2506-M8x30 2407-M10x30
AFM90-RT10-D050-A22-Z07-H	●	50	7	22	40	10				
AFM90-RT10-D063-A22-Z09-H	●	63	9	22	40	10				
new AFM90-RT16-D040-A16-Z04-H	●	40	4	16	40	16	RT 1606	4015-M4x11	80-T15	2506-M8x30 2508-M10x30 2510-M12x35
new AFM90-RT16-D063-A22-Z06-H	●	63	6	22	40	16				
new AFM90-RT16-D080-A27-Z07-H	●	80	7	27	50	16				
new AFM90-RT16-D125-B40-Z09	●	125	9	40	63	16				

R: Sağ / Right / Правый L: Sol / Left / Левый
● Stokta / In Stock / В наличии ○ Stokta Yok / Non Stock Item / Нет в наличии
SFTY Ucuna Uygunur. / Compatible with SFTY Insert. / Под пластину SFTY

Sipariş Örneği/Ordering Example/Образец заказа
1 ad./pcs./шт. AFM90-490R08-D063-A22-Z06-H

Kesme Hesabı : S 377 / Cutting Calculation : P 377 / Расчет режимов резания: стр. 377
Montaj Ölçüleri : S 374 / Mounting Reference : P 374 / Инструкция по установке фрез: стр. 374

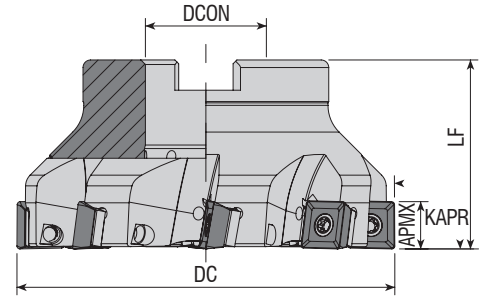

Takım Kodu Ordering Code Код для заказа	Stok Stock Наличие	Takım Ölçüleri (mm) Dimension (mm) Размеры (мм)					Kesici Uç Insert Пластина	Yedek Parçaları / Spare Parts / Запасные части				
		DC	ZEFP	DCON	LF	APMX		Altlık Screw Unterlage	Baskı Parçası Wedge Clamp Прижим	Sıkma Vidası Screw Зажимной винт	Tork Anahtar Torx Key Торх Ключ	Montaj Vidası Mounting Screw Монтажный винт
AFM90S-SD1204-D050-A22-Z04-H	●	50	4	22	40	11	SDMT 1204..	AASD-3-0001	AAV-08-M3.5x8	4015-M3.5x12	80-T15	2408-M10x30
AFM90S-SD1204-D063-A22-Z05-H	●	63	5	22	40	11						2508-M10x30
AFM90S-SD1204-D080-A27-Z06-H	●	80	6	27	50	11						2510-M12x35
AFM90S-SD1204-D100-A32-Z08-H	●	100	8	32	50	11						2514-M16x35
AFM90S-SD1204-D125-B40-Z10	●	125	10	40	63	11						-
AFM90S-SD1204-D160-C40-Z12	●	160	12	40	63	11						-

DJT Ucuna Uygunudur. / Compatible with DJT Insert. / Под пластину DJT

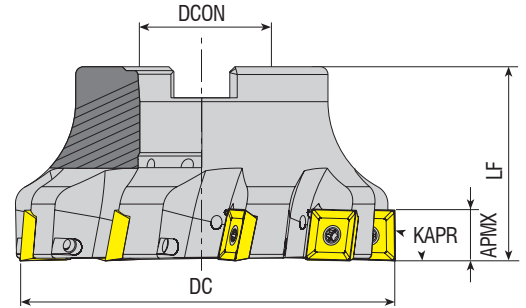

Takım Kodu Ordering Code Код для заказа	Stok Stock Наличие	Takım Ölçüleri (mm) Dimension (mm) Размеры (мм)					Kesici Uç Insert Пластина	Yedek Parçaları / Spare Parts / Запасные части		
		DC	ZEFP	DCON	LF	APMX		Sıkma Vidası Screw Зажимной винт	Tork Anahtar Torx Key Торх Ключ	Montaj Vidası Mounting Screw Монтажный винт
AFM90-SD09M4-D040-A16-Z04-H	●	40	4	16	40	9	SD.. 09M4..	4015-M3.5x11	80-T15	2406-M8x30
AFM90-SD09M4-D050-A22-Z05-H	●	50	5	22	40	9				2508-M10x30
AFM90-SD09M4-D063-A22-Z06-H	●	63	6	22	40	9				2510-M12x35
AFM90-SD09M4-D080-A27-Z07-H	●	80	7	27	50	9				-
AFM90-SD1305-D050-A22-Z04-H	●	50	4	22	40	13	SD.. 1305..	1020-M5x11	80-T20	2408-M10x30
AFM90-SD1305-D063-A22-Z05-H	●	63	5	22	50	13				2508-M10x30
AFM90-SD1305-D080-A27-Z06-H	●	80	6	27	50	13				2510-M12x35
AFM90-SD1305-D100-A32-Z07-H	●	100	7	32	50	13				2514-M16x35
AFM90-SD1305-D125-B40-Z08	●	125	8	40	63	13				-
AFM90-SD1305-D160-C40-Z10	●	160	10	40	63	13				-

R: Sağ / Right / Правый L: Sol / Left / Левый
● Stokta / In Stock / В наличии ○ Stokta Yok / Non Stock Item / Нет в наличии
KRLY Ucuna Uygunudur. / Compatible with KRLY Insert. / Под пластину KRLY

Sipariş Örneği/Ordering Example/Образец заказа
1 ad./pcs./шт. AFM90S-SD1204-D050-A22-Z04-H

Kesme Hesabı : S 377 / Cutting Calculation : P 377 / Расчет режимов резания: стр. 377
Montaj Ölçüleri : S 374 / Mounting Reference : P 374 / Инструкция по установке фрез: стр. 374

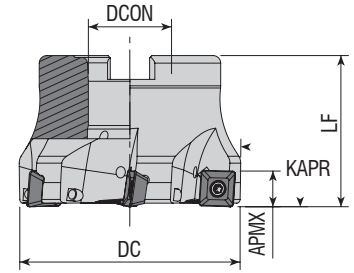

Takım Kodu Ordering Code Код для заказа	Stok Stock Наличие	Takım Ölçüleri (mm) Dimension (mm) Размеры (мм)					Kesici Uç Insert Пластина	Yedek Parçaları / Spare Parts / Запасные части		
		DC	ZEPF	DCON	LF	APMX		Sıkma Vidası Screw Зажимной винт	Tork Anahtar Torx Key Торх Ключ	Montaj Vidası Mounting Screw Монтажный винт
AFM90-SE09-D040-A16-Z04-H	●	40	4	16	40	6.7	SEET 09T3..	3008-M3x8	82-T08	2506-M8x30
AFM90-SE09-D050-A22-Z05-H	●	50	5	22	40	6.7				2508-M10x30
AFM90-SE09-D063-A22-Z06-H	●	63	6	22	40	6.7				-

ZCC Ucuna Uygundur. / Compatible with ZCC Insert. / Под пластину ZCC

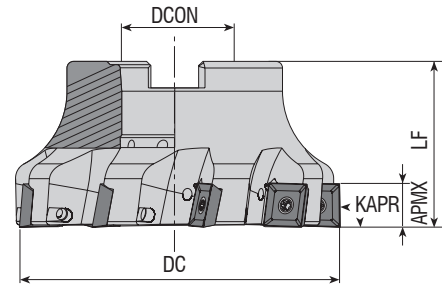

Takım Kodu Ordering Code Код для заказа	Stok Stock Наличие	Takım Ölçüleri (mm) Dimension (mm) Размеры (мм)					Kesici Uç Insert Пластина	Yedek Parçaları / Spare Parts / Запасные части		
		DC	ZEPF	DCON	LF	APMX		Sıkma Vidası Screw Зажимной винт	Tork Anahtar Torx Key Торх Ключ	Montaj Vidası Mounting Screw Монтажный винт
AFM90-SE12-D050-A22-Z04-H	●	50	4	22	40	12	SEET 1203..	4015-M3.5x11	80-T15	2508-M10x30
AFM90-SE12-D063-A22-Z05-H	●	63	5	22	40	12				2510-M12x35
AFM90-SE12-D080-A27-Z07-H	●	80	7	27	50	12				2514-M16x35
AFM90-SE12-D100-A32-Z09-H	●	100	9	32	50	12				-
AFM90-SE12-D125-B40-Z11	●	125	11	40	63	12				-

R: Sağ / Right / Правый L: Sol / Left / Левый

● Stokta / In Stock / В наличии ○ Stokta Yok / Non Stock Item / Нет в наличии

ZCC Ucuna Uygundur. / Compatible with ZCC Insert. / Под пластину ZCC

Sipariş Örneği/Ordering Example/Образец заказа
1 ad./pcs./шт. AFM90-SE09-D040-A16-Z04-H

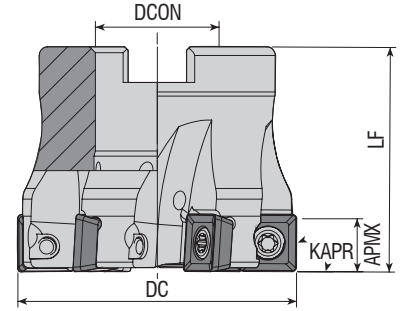

Takım Kodu Ordering Code Код для заказа	Stok Stock Наличие	Takım Ölçüleri (mm) Dimension (mm) Размеры (мм)					Kesici Uç Insert Пластина	Yedek Parçaları / Spare Parts / Запасные части		
		DC	ZEFP	DCON	LF	APMX		Sıkma Vidası Screw Зажимной винт	Tork Anahtar Torx Key Торх Ключ	Montaj Vidası Mounting Screw Монтажный винт
AFM90-SP1004-D040-A16-Z04-H	●	40	4	16	40	9.4	SPMT 1004.. XPMT 1004.. QPMR 1004.. QPMT 1004..	4015-M4x10	80-T15	2506-M8x30
AFM90-SP1004-D050-A22-Z04-H	●	50	4	22	40	9.4				2508-M10x30
AFM90-SP1004-D050-A22-Z06-H	●	50	6	22	40	9.4				2510-M12x35
AFM90-SP1004-D063-A22-Z05-H	●	63	5	22	40	9.4				2514-M16x35
AFM90-SP1004-D080-A27-Z07-H	●	80	7	27	50	9.4				
AFM90-SP1004-D100-A32-Z08-H	●	100	8	32	50	9.4				

ISCR Ucuna Uygundur. / Compatible with ISCR Insert. / Под пластину ISCR

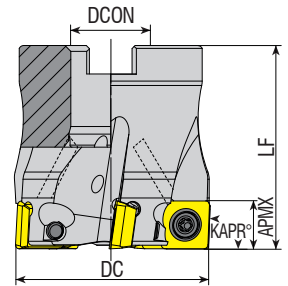

Takım Kodu Ordering Code Код для заказа	Stok Stock Наличие	Takım Ölçüleri (mm) Dimension (mm) Размеры (мм)					Kesici Uç Insert Пластина	Yedek Parçaları / Spare Parts / Запасные части		
		DC	ZEFP	DCON	LF	APMX		Sıkma Vidası Screw Зажимной винт	Tork Anahtar Torx Key Торх Ключ	Montaj Vidası Mounting Screw Монтажный винт
AFM90-SP09T3-D040-A16-Z05-H	●	40	5	16	40	8.6	SPMT 09T3..	3010-M3.5x9	82-T10	2506-M8x30
AFM90-SP09T3-D050-A22-Z06-H	●	50	6	22	40	8.6				2508-M10x30
AFM90-SP09T3-D063-A22-Z07-H	●	63	7	22	40	8.6				2510-M12x35
AFM90-SP09T3-D080-A27-Z08-H	●	80	8	27	50	8.6				

R: Sağ / Right / Правый L: Sol / Left / Левый

● Stokta / In Stock / В наличии ○ Stokta Yok / Non Stock Item / Нет в наличии

SNDVK Ucuna Uygundur. / Compatible with SNDVK Insert. / Под пластину SNDVK

Sipariş Örneği/Ordering Example/Образец заказа
1 ad./pcs./шт. AFM90-SP1004-D040-A16-Z04-H

Kesme Hesabı : S 377 / Cutting Calculation : P 377 / Расчет режимов резания: стр. 377
Montaj Ölçüleri : S 374 / Mounting Reference : P 374 / Инструкция по установке фрез: стр. 374



new

KAPR=90°

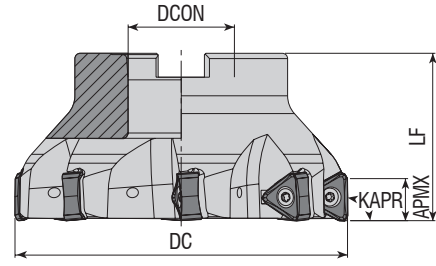
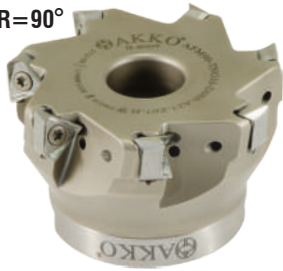

Takım Kodu
Ordering Code
Код для заказа

Stok
Stock
Наличие

Takım Ölçüleri (mm)
Dimension (mm)
Размеры (мм)

Kesici Uç
Insert
Пластина

Yedek Parçaları / Spare Parts / Запасные части

Sıkma Vidası
Screw
Зажимной винт

Tork Anahtar
Torx Key
Торх Ключ

Montaj Vidası
Mounting Screw
Монтажный винт

Takım Kodu Ordering Code Код для заказа	Stok Stock Наличие	DC	ZEPF	DCON	LF	APMX	Kesici Uç Insert Пластина	Sıkma Vidası Screw Зажимной винт	Tork Anahtar Torx Key Торх Ключ	Montaj Vidası Mounting Screw Монтажный винт
AFM90-TNG10-D040-A16-Z04-H	●	40	4	16	40	5	TNGX 1004..	3008-M2.5x6	82-T08	2506-M8x30
AFM90-TNG10-D040-A16-Z06-H	○	40	6	16	40	5				2508-M10X30
AFM90-TNG10-D050-A22-Z05-H	○	50	5	22	40	5				2510-M12X35
AFM90-TNG10-D050-A22-Z07-H	○	50	7	22	40	5				
AFM90-TNG10-D063-A22-Z06-H	○	63	6	22	40	5				
AFM90-TNG10-D063-A22-Z09-H	○	63	9	22	40	5				
AFM90-TNG10-D080-A27-Z10-H	○	80	10	27	50	5				
AFM90-TNG16-D040-A16-Z03-H	○	40	3	16	40	10	TNGX 1606..	3015-M4x11	80-T15	
AFM90-TNG16-D040-A16-Z04-H	○	40	4	16	40	10				
AFM90-TNG16-D050-A22-Z04-H	○	50	4	22	40	10				
AFM90-TNG16-D050-A22-Z05-H	○	50	5	22	40	10				
AFM90-TNG16-D063-A22-Z04-H	○	63	4	22	40	10				
AFM90-TNG16-D063-A22-Z06-H	○	63	6	22	40	10				
AFM90-TNG16-D080-A27-Z05-H	○	80	5	27	50	10				
AFM90-TNG16-D080-A27-Z07-H	●	80	7	27	50	10				
AFM90-TNG16-D100-A32-Z06-H	○	100	6	32	50	10				
AFM90-TNG16-D100-A32-Z08-H	○	100	8	32	50	10				
AFM90-TNG16-D115-A32-Z06-H	○	115	6	32	50	10				
AFM90-TNG16-D125-A40-Z07-H	○	125	7	40	63	10				
AFM90-TNG16-D125-A40-Z09-H	○	125	9	40	63	10				
AFM90-TNG16-D140-B40-Z08-H	○	140	8	40	63	10				
AFM90-TNG16-D160-C40-Z10-H	○	160	10	40	63	10				
AFM90-TNG16-D175-C40-Z10-H	○	175	10	40	63	10				

R: Sağ / Right / Правый L: Sol / Left / Левый

● Stokta / In Stock / В наличии ○ Stokta Yok / Non Stock Item / Нет в наличии

PRMT Ucuna Uygunudur. / Compatible with PRMT Insert. / Под пластину PRMT .

Sipariş Örneği/Ordering Example/Образец заказа
1 ad./pcs./шт. AFM90-TNG10-D040-A16-Z04-H

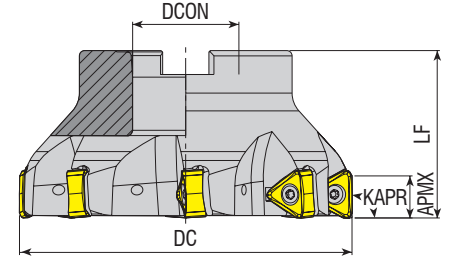

Takım Kodu Ordering Code Код для заказа	Stok Stock Наличие	Takım Ölçüleri (mm) Dimension (mm) Размеры (мм)					Kesici Uç Insert Пластина	Yedek Parçaları / Spare Parts / Запасные части		
		DC	ZEFP	DCON	LF	APMX		Sıkma Vidası Screw Зажимной винт	Tork Anahtar Torx Key Торх Ключ	Montaj Vidası Mounting Screw Монтажный винт
AFM90-TN2207-D063-A22-Z04-H	●	63	4	22	40	15	TN.X 2207..	1120-M4.5x12	80-T20	2508-M10x30
AFM90-TN2207-D080-A27-Z05-H	●	80	5	27	50	15				2510-M12x35
AFM90-TN2207-D100-B32-Z06	●	100	6	32	50	15				2514-M16x35
AFM90-TN2207-D125-B40-Z08	●	125	8	40	63	15				-

TGTC Ucuna Uygunudur. / Compatible with TGTC Insert. / Под пластину TGTC

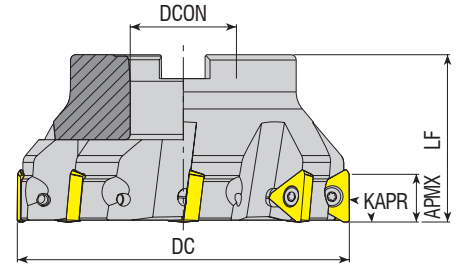

Takım Kodu Ordering Code Код для заказа	Stok Stock Наличие	Takım Ölçüleri (mm) Dimension (mm) Размеры (мм)					Kesici Uç Insert Пластина	Yedek Parçaları / Spare Parts / Запасные части		
		DC	ZEFP	DCON	LF	APMX		Sıkma Vidası Screw Зажимной винт	Tork Anahtar Torx Key Торх Ключ	Montaj Vidası Mounting Screw Монтажный винт
AFM90-TP2205-D063-A22-Z04	●	63	4	22	40	18	TPKT 2205..	1120-M4.5x12	80-T20	2508-M10x30
AFM90-TP2205-D080-A27-Z06	●	80	6	27	50	18				2510-M12x35
AFM90-TP2205-D100-A32-Z07	●	100	7	32	50	18				2514-M16x35
AFM90-TP2205-D125-B40-Z08	●	125	8	40	63	18				-
AFM90-TP2205-D160-C40-Z09	●	160	9	40	63	18				-
AFM90-TP2205-D200-C60-Z12	●	200	12	60	63	18				-

R: Sağ / Right / Правый L: Sol / Left / Левый
● Stokta / In Stock / В наличии ○ Stokta Yok / Non Stock Item / Нет в наличии
TGTC Ucuna Uygunudur. / Compatible with TGTC Insert. / Под пластину TGTC

Sipariş Örneği/Ordering Example/Образец заказа
1 ad./pcs./шт. AFM90-TN2207-D063-A22-Z04-H

Kesme Hesabı : S 377 / Cutting Calculation : P 377 / Расчет режимов резания: стр. 377
Montaj Ölçüleri : S 374 / Mounting Reference : P 374 / Инструкция по установке фрез: стр. 374

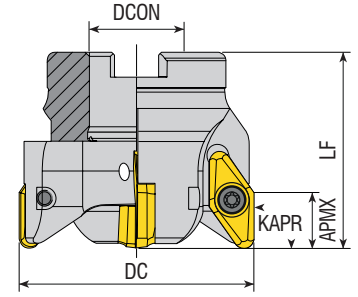
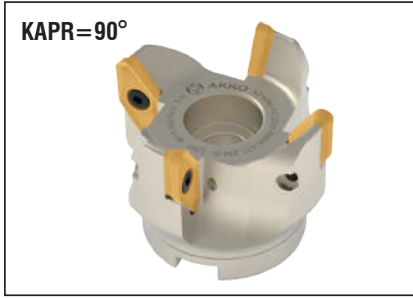

Takım Kodu Ordering Code Код для заказа	Stok Stock Наличие	Takım Ölçüleri (mm) Dimension (mm) Размеры (мм)					Kesici Uç Insert Пластина	Yedek Parçaları / Spare Parts / Запасные части			
		DC	ZEFP	DCON	LF	APMX		Sıkma Vidası Screw Зажимной винт	Tork Anahtar Torx Key Торх Ключ	Montaj Vidası Mounting Screw Монтажный винт	
AFM90-VC2205-D050-A22-Z03-H	●	50	3	22	55	15	VCKT 2205..				
AFM90-VC2205-D063-A22-Z04-H	●	63	4	22	55	15					
AFM90-VC2205-D066-A27-Z04-H	●	66	4	27	55	15					
AFM90-VC2205-D080-A27-Z05-H	●	80	5	27	60	15					

ISO Ucuna Uygundur. / Compatible with ISO Insert. / Под пластину ISO

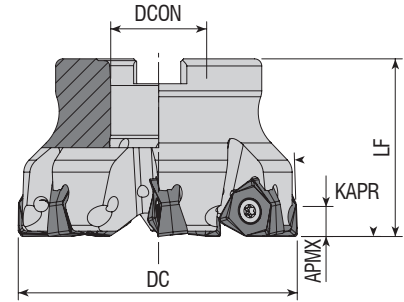
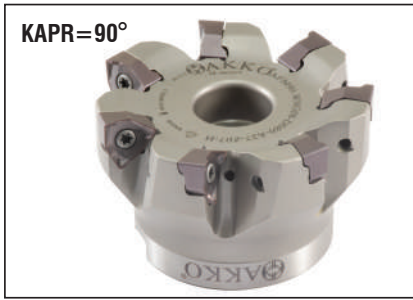

Takım Kodu Ordering Code Код для заказа	Stok Stock Наличие	Takım Ölçüleri (mm) Dimension (mm) Размеры (мм)					Kesici Uç Insert Пластина	Yedek Parçaları / Spare Parts / Запасные части			
		DC	ZEFP	DCON	LF	APMX		Sıkma Vidası Screw Зажимной винт	Tork Anahtar Torx Key Торх Ключ	Montaj Vidası Mounting Screw Монтажный винт	
AFM90-WNG04-D040-A16-Z06-H	●	40	6	16	40	4	WNGU 0403..				
AFM90-WNG04-D050-A22-Z05-H	●	50	5	22	40	4					
AFM90-WNG04-D050-A22-Z07-H	●	50	7	22	40	4					
AFM90-WNG04-D063-A22-Z06-H	●	63	6	22	40	4					
AFM90-WNG08-D050-A22-Z05-H	●	50	5	22	40	7.5	WNGU 0806..				
AFM90-WNG08-D063-A22-Z06-H	●	63	6	22	40	7.5					
AFM90-WNG08-D080-A27-Z07-H	●	80	7	27	50	7.5					
new AFM90-WNG08-D100-A32-Z07-H	●	100	10	32	50	7.5					

R: Sağ / Right / Правый L: Sol / Left / Левый

● Stokta / In Stock / В наличии ○ Stokta Yok / Non Stock Item / Нет в наличии

XTC-GSC Ucuna Uygundur. / Compatible with XTC-GSC Insert. / Под пластину XTC-GSC

Sipariş Örneği/Ordering Example/Образец заказа

1 ad./pcs./шт. AFM90-VC2205-D050-A22-Z03-H

Kesme Hesabı : S 377 / Cutting Calculation : P 377 / Расчет режимов резания: стр. 377

Montaj Ölçüleri : S 374 / Mounting Reference : P 374 / Инструкция по установке фрез: стр. 374

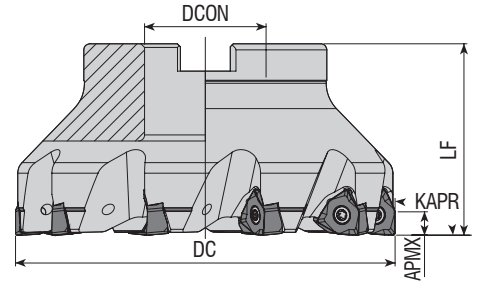

Takım Kodu Ordering Code Код для заказа	Stok Stock Наличие	Takım Ölçüleri (mm) Dimension (mm) Размеры (мм)					Kesici Uç Insert Пластина	Yedek Parçaları / Spare Parts / Запасные части		
		DC	ZEFP	DCON	LF	APMX		Sıkma Vidası Screw Зажимной винт	Tork Anahtar Torx Key Торх Ключ	Montaj Vidası Mounting Screw Монтажный винт
AFM90-WN0604Z-D040-A16-Z04-H	●	40	4	16	40	5.7	WNHU 0604..	3008-M3x8	82-T08	2506-M8x30
AFM90-WN0604Z-D050-A22-Z05-H	●	50	5	22	40	5.7				2508-M10x30
AFM90-WN0604Z-D063-A22-Z06-H	●	63	6	22	40	5.7				2510-M12x35
AFM90-WN0604Z-D080-A27-Z07-H	●	80	7	27	50	5.7				2514-M16x35
AFM90-WN0604Z-D100-A32-Z09-H	●	100	9	32	50	5.7				-
AFM90-WN0806Z-D050-A22-Z04-H	●	50	4	22	40	7.7	WNHU 0806..	4015-M4x11	80-T15	2508-M10x30
AFM90-WN0806Z-D063-A22-Z05-H	●	63	5	22	40	7.7				2510-M12x35
AFM90-WN0806Z-D080-A27-Z06-H	●	80	6	27	50	7.7				2514-M16x35
AFM90-WN0806Z-D100-A32-Z08-H	●	100	8	32	50	7.7				-
AFM90-WN0806Z-D125-B40-Z10	●	125	10	40	63	7.7				-
AFM90-WN0806Z-D160-C40-Z12	●	160	12	40	63	7.7	-	-	-	

ZCC Ucuna Uygundur. / Compatible with ZCC Insert. / Под пластину ZCC

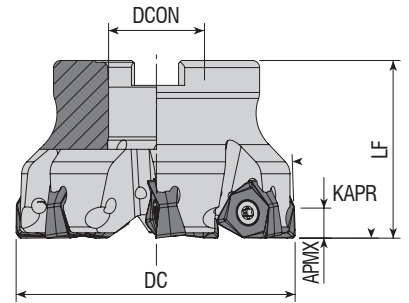

Takım Kodu Ordering Code Код для заказа	Stok Stock Наличие	Takım Ölçüleri (mm) Dimension (mm) Размеры (мм)					Kesici Uç Insert Пластина	Yedek Parçaları / Spare Parts / Запасные части		
		DC	ZEFP	DCON	LF	APMX		Sıkma Vidası Screw Зажимной винт	Tork Anahtar Torx Key Торх Ключ	Montaj Vidası Mounting Screw Монтажный винт
AFM90-WN0806-D050-A16-Z04-H	●	50	4	16	40	8	WNMX 080608	1615-M5x14	80-T15	2506-M8x30
AFM90-WN0806-D063-A22-Z05-H	●	63	5	22	40	8				2508-M10x30
AFM90-WN0806-D080-A27-Z07-H	●	80	7	27	50	8				2510-M12x35

R: Sağ / Right / Правый L: Sol / Left / Левый

● Stokta / In Stock / В наличии ○ Stokta Yok / Non Stock Item / Нет в наличии

KYCR-JD Ucuna Uygundur. / Compatible with KYCR-JD Insert. / Под пластину KYCR-JD

Sipariş Örneği/Ordering Example/Образец заказа

1 ad./pcs./шт. AFM90-WN0604Z-D040-A16-Z04-H

Kesme Hesabı : S 377 / Cutting Calculation : P 377 / Расчет режимов резания: стр. 377

Montaj Ölçüleri : S 374 / Mounting Reference : P 374 / Инструкция по установке фрез: стр. 374

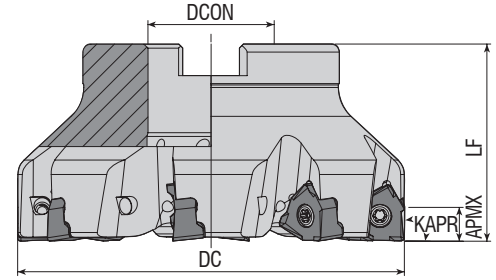

Takım Kodu Ordering Code Код для заказа	Stok Stock Наличие	Takım Ölçüleri (mm) Dimension (mm) Размеры (мм)					Kesici Uç Insert Пластина	Yedek Parçaları / Spare Parts / Запасные части			
		DC	ZEPF	DCON	LF	APMX		Sıkma Vidası Screw Зажимной винт	Tork Anahtar Torx Key Торх Ключ	Montaj Vidası Mounting Screw Монтажный винт	
AFM90-XN0403-D040-A16-Z05-H	●	40	5	16	40	4	XNEX 0403.. XNEX 0806..	3008-M2.5x6 4015-M4x11	82-T08 80-T15	2506-M8x30	
AFM90-XN0806-D050-A22-Z04-H	●	50	4	22	40	7.5				2508-M10x30	
AFM90-XN0806-D063-A22-Z05-H	●	63	5	22	40	7.5				2510-M12x35	
AFM90-XN0806-D080-A27-Z07-H	●	80	7	27	50	7.5				2514-M16x35	
AFM90-XN0806-D100-A32-Z08-H	●	100	8	32	50	7.5					

SC Ucuna Uygunur. / Compatible with SC Insert. / Под пластину SC

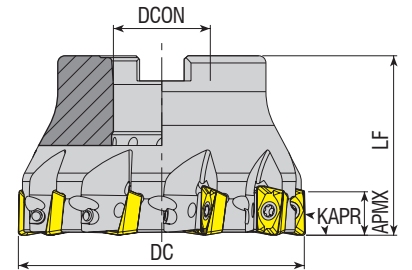

Takım Kodu Ordering Code Код для заказа	Stok Stock Наличие	Takım Ölçüleri (mm) Dimension (mm) Размеры (мм)					Kesici Uç Insert Пластина	Yedek Parçaları / Spare Parts / Запасные части			
		DC	ZEPF	DCON	LF	APMX		Sıkma Vidası Screw Зажимной винт	Tork Anahtar Torx Key Торх Ключ	Montaj Vidası Mounting Screw Монтажный винт	
AFM90-X012-D040-A16-Z05-H	●	40	5	16	40	11	XO.. 1204..	3010-M3.5x9	82-T10	2506-M8x30	
AFM90-X012-D050-A22-Z07-H	●	50	7	22	40	11				2508-M10x30	
AFM90-X012-D063-A22-Z08-H	●	63	8	22	40	11				2510-M12x35	
AFM90-X012-D080-A27-Z10-H	●	80	10	27	50	11				2514-M16x35	
AFM90-X012-D100-A32-Z12-H	●	100	12	32	50	11					

R: Sağ / Right / Правый L: Sol / Left / Левый

● Stokta / In Stock / В наличии ○ Stokta Yok / Non Stock Item / Нет в наличии

SC Ucuna Uygunur. / Compatible with SC Insert. / Под пластину SC

Sipariş Örneği/Ordering Example/Образец заказа

1 ad./pcs./шт. AFM90-XN0403-D040-A16-Z05-H

Kesme Hesabı : S 377 / Cutting Calculation : P 377 / Расчет режимов резания: стр. 377

Montaj Ölçüleri : S 374 / Mounting Reference : P 374 / Инструкция по установке фрез: стр. 374

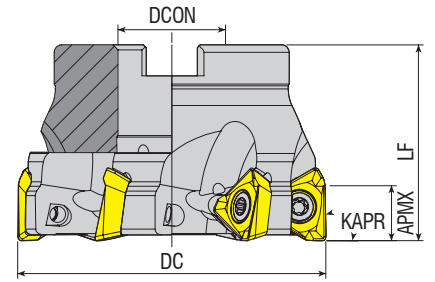

Takım Kodu Ordering Code Код для заказа	Stok Stock Наличие	Takım Ölçüleri (mm) Dimension (mm) Размеры (мм)					Kesici Uç Insert Пластина	Yedek Parçaları / Spare Parts / Запасные части			
		DC	ZEFP	DCON	LF	APMX		Sıkma Vidası Screw Зажимной винт	Tork Anahtar Torx Key Торк Ключ	Montaj Vidası Mounting Screw Монтажный винт	
AFM90-3P1004-D040-A16-Z05-H	●	40	5	16	40	7	3PKT 1004..	1108-M2.5x6	82-T08	2506-M8x30	
AFM90-3P1004-D050-A22-Z06-H	●	50	6	22	40	7					
AFM90-3P1505-D050-A22-Z04-H	●	50	4	22	40	11					
AFM90-3P1505-D050-A22-Z05-H	●	50	5	22	40	11					
AFM90-3P1505-D063-A22-Z04-H	●	63	4	22	40	11					
AFM90-3P1505-D063-A22-Z06-H	●	63	6	22	40	11					
AFM90-3P1505-D080-A27-Z07-H	●	80	7	27	50	11					
AFM90-3P1505-D100-A32-Z08-H	●	100	8	32	50	11					
AFM90-3P1505-D125-B40-Z10	●	125	10	40	63	11	3PKT 1906..	1120-M4.5x12	80-T20	2514-M16x35	
new AFM90-3P1906-D080-A27-Z07-H	●	80	7	27	50	15					
new AFM90-3P1906-D100-A32-Z08-H	●	100	8	32	50	15					
new AFM90-3P1906-D125-B40-Z10	●	125	10	40	63	15					

TGTC Ucuna Uygundur. / Compatible with TGTC Insert. / Под пластину TGTC

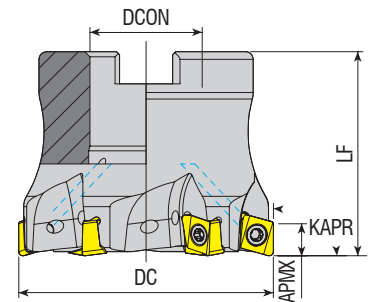

Takım Kodu Ordering Code Код для заказа	Stok Stock Наличие	Takım Ölçüleri (mm) Dimension (mm) Размеры (мм)					Kesici Uç Insert Пластина	Yedek Parçaları / Spare Parts / Запасные части			
		DC	ZEFP	DCON	LF	APMX		Sıkma Vidası Screw Зажимной винт	Tork Anahtar Torx Key Торк Ключ	Montaj Vidası Mounting Screw Монтажный винт	
AFM90-4N06-D040-A16-Z05-H	●	40	5	16	40	6	4NKT 0603..	1108-M3x6.8	82-T08	2506-M8x30	
AFM90-4N06-D050-A22-Z06-H	●	50	6	22	40	6				2508-M10x30	

R: Sağ / Right / Правый L: Sol / Left / Левый
● Stokta / In Stock / В наличии ○ Stokta Yok / Non Stock Item / Нет в наличии
TGTC Ucuna Uygundur. / Compatible with TGTC Insert. / Под пластину TGTC

Sipariş Örneği/Ordering Example/Образец заказа
1 ad./pcs./шт. AFM90-3P1004-D040-A16-Z05-H

Kesme Hesabı : S 377 / Cutting Calculation : P 377 / Расчет режимов резания: стр. 377
Montaj Ölçüleri : S 374 / Mounting Reference : P 374 / Инструкция по установке фрез: стр. 374



KAPR=90°

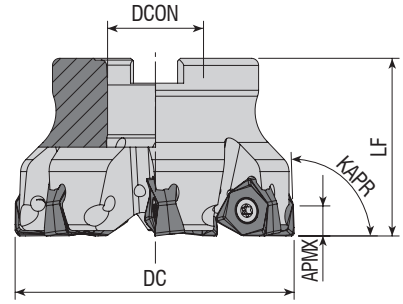
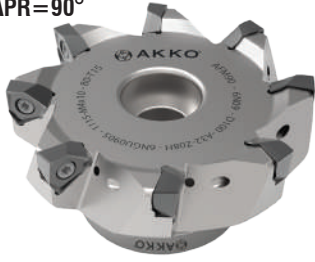

Takım Kodu Ordering Code Код для заказа	Stok Stock Наличие	Takım Ölçüleri (mm) Dimension (mm) Размеры (мм)					Kesici Uç Insert Пластина	Yedek Parçaları / Spare Parts / Запасные части		
		DC	ZEFP	DCON	LF	APMX		Sıkma Vidası Screw Зажимной винт	Tork Anahtar Torx Key Торкс Ключ	Montaj Vidası Mounting Screw Монтажный винт
AFM90-6N09-D050-A22-Z05-H	○	50	5	22	40	9	6NGU 0905..	1115-M4x10	80-T15	2508-M10x30
AFM90-6N09-D063-A22-Z06-H	●	63	6	22	40	9				2510-M12x35
AFM90-6N09-D080-A27-Z07-H	○	80	7	27	50	9				2514-M16x35
AFM90-6N09-D100-A32-Z08-H	●	100	8	32	50	9				-
AFM90-6N14-D050-A22-Z04-H	○	50	4	22	50	8.2	6NMU 1409..	1120-M5x12	80-T20	2508-M10x30
AFM90-6N14-D063-A22-Z05-H	○	63	5	22	40	8.2				2510-M12x35
AFM90-6N14-D080-A27-Z07-H	○	80	7	27	50	8.2				2514-M16x35
AFM90-6N14-D100-A32-Z07-H	○	100	7	32	50	8.2				-
AFM90-6N14-D125-B40-Z08	○	125	8	40	63	8.2	-	-	-	-

R: Sağ / Right / Правый L: Sol / Left / Левый
● Stokta / In Stock / В наличии ○ Stokta Yok / Non Stock Item / Нет в наличии
MTSBH Ucuna Uygunudur. / Compatible with MTSBH Insert. / Под пластину MTSBH

Sipariş Örneği/Ordering Example/Образец заказа
1 ad./pcs./шт. AFM90-6N09-D050-A22-Z05-H
Kesme Hesabı : S 377 / Cutting Calculation : P 377 / Расчет режимов резания: стр. 377
Montaj Ölçüleri : S 374 / Mounting Reference : P 374 / Инструкция по установке фрез: стр. 374



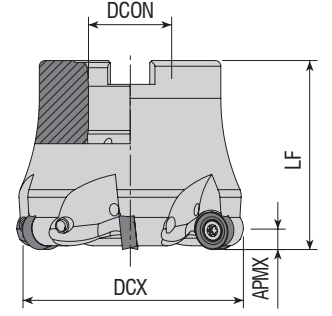

Takım Kodu Ordering Code Код для заказа	Stok Stock Наличие	Takım Ölçüleri (mm) Dimension (mm) Размеры (мм)					Kesici Uç Insert Пластина	Yedek Parçaları / Spare Parts / Запасные части		
		DCX	ZEFP	DCON	LF	APMX		Sıkma Vidası Screw Зажимной винт	Tork Anahtar Torx Key Торх Ключ	Montaj Vidası Mounting Screw Монтажный винт
AFMR-RC10T3-D040-A16-Z04-H	●	40	4	16	40	5	RC.. 10T3..	4015-M4x11	80-T15	2406-M8x30
AFMR-RC10T3-D050-A22-Z05-H	●	50	5	22	50	5				2508-M10x30
AFMR-RC10T3-D063-A22-Z06-H	●	63	6	22	50	5				

ZCC Ucuna Uygunudur. / Compatible with ZCC Insert. / Под пластину ZCC

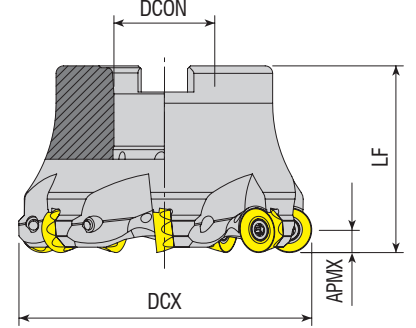

Takım Kodu Ordering Code Код для заказа	Stok Stock Наличие	Takım Ölçüleri (mm) Dimension (mm) Размеры (мм)					Kesici Uç Insert Пластина	Yedek Parçaları / Spare Parts / Запасные части		
		DCX	ZEFP	DCON	LF	APMX		Sıkma Vidası Screw Зажимной винт	Tork Anahtar Torx Key Торх Ключ	Montaj Vidası Mounting Screw Монтажный винт
AFMR-RC1204-D040-A16-Z04-H	●	40	4	16	40	6	RC.. 1204..	4015-M3.5x11	80-T15	2506-M8x30
AFMR-RC1204-D050-A22-Z05-H	●	50	5	22	50	6				2508-M10x30
AFMR-RC1204-D052-A22-Z05-H	●	52	5	22	50	6				
AFMR-RC1204-D063-A22-Z06-H	●	63	6	22	50	6				
AFMR-RC1204-D063-A27-Z06-H	●	63	6	27	50	6				
AFMR-RC1204-D080-A27-Z07-H	●	80	7	27	50	6				2510-M12x35

R: Sağ / Right / Правый L: Sol / Left / Левый

● Stokta / In Stock / В наличии ○ Stokta Yok / Non Stock Item / Нет в наличии

SNDVK Ucuna Uygunudur. / Compatible with SNDVK Insert. / Под пластину SNDVK

Sipariş Örneği/Ordering Example/Образец заказа

1 ad./pcs./шт. AFMR-RC10T3-D040-A16-Z04-H

Kesme Hesabı : S 377 / Cutting Calculation : P 377 / Расчет режимов резания: стр. 377

Montaj Ölçüleri : S 374 / Mounting Reference : P 374 / Инструкция по установке фрез: стр. 374

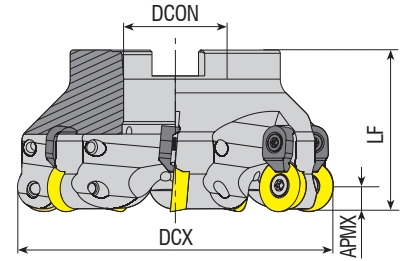

Takım Kodu Ordering Code Код для заказа	Stok Stock Наличие	Takım Ölçüleri (mm) Dimension (mm) Размеры (мм)					Kesici Uç Insert Пластина	Yedek Parçaları / Spare Parts / Запасные части					
		DCX	ZEPF	DCON	LF	APMX		Sıkma Vidası Screw Зажимной винт	Baskı Parçası Wedge Clamp Прижим	Baskı Vidası Clamp Screw Зажимной винт	Tork Anahtar Torx Key Торк Ключ	Montaj Vidası Mounting Screw Монтажный винт	
AFMR-RD0702-D050-A22-Z06-H	●	50	6	22	40	3.5	RD.. 0702	3008-M2.5x6	-	-	82-T08	2407-M10x30	
AFMR-RD0803-D050-A22-Z05-H	●	50	5	22	40	4	RD.. 0803	3008-M3x8	-	-	82-T08	2406-M8x30	
new AFMRC-RD1003-D040-A16-Z04-H	●	40	4	16	40	5	RD.. 1003	4015-M3.5x11	-	-	82-T08	2406-M8x30	
AFMR-RD1003-D040-A16-Z05-H	●	40	5	16	40	5						2508-M10x30	
AFMRC-RD1003-D050-A22-Z05-H	●	50	5	22	50	5						2510-M12X35	
AFMRC-RD1003-D052-A22-Z05	●	52	5	22	50	5						2514-M16x35	
AFMRC-RD1003-D063-A22-Z06-H	●	63	6	22	50	5						-	
new AFMRC-RD1003-D066-A27-Z07-H	●	66	7	27	50	5						-	
AFMRC-RD1003-D080-A27-Z07-H	●	80	7	27	50	5	-	-	-	-	-	-	
AFMRC-RD1003-D100-A32-Z08-H	●	100	8	32	50	5	-	-	-	-	-	-	
new AFMR-RD1004-D063-A22-Z06-H	●	63	6	22	50	50	RD.. 1004	4515-M4x8	-	-	-	-	
new AFMRC-RD10T3-D040-A16-Z05-H	●	40	5	16	40	5	RD.. 10T3	4015-M3.5x9	-	-	82-T08	2406-M8X30	
new AFMRC-RD10T3-D042-A16-Z05-H	●	42	5	16	40	5						2508-M10X30	
AFMRC-RD10T3-D050-A22-Z05-H	●	50	5	22	50	5						-	
AFMRC-RD10T3-D052-A22-Z05-H	●	52	5	22	40	5						-	
new AFMRC-RD10T3-D052-A22-Z06-H	●	52	6	22	40	5						-	
new AFMRC-RD10T3-D063-A22-Z06-H	●	63	6	22	50	5						-	
new AFMR-RD12T3-D066-A27-Z06-H	●	66	6	22	50	50	RD.. 12T3	4015-M3.5x11	ACK-15	4015-M3.5x11	80-T15	2406-M8X30	
AFMRC-RD12T3-D040-A16-Z04-H	●	40	4	27	50	6						2508-M10X30	
AFMRC-RD12T3-D050-A22-Z05-H	●	50	5	16	40	6						2510-M12X35	
AFMRC-RD12T3-D052-A22-Z05-H	●	52	5	22	50	6						2514-M16x35	
AFMRC-RD12T3-D063-A22-Z06-H	●	63	6	22	50	6						-	
AFMRC-RD12T3-D080-A27-Z07-H	●	80	7	22	50	6						-	
AFMRC-RD12T3-D100-A32-Z08-H	●	100	8	27	50	6	-	-	-	-	-	-	
AFMRC-RD12T3-D125-B40-Z09	●	125	9	32	50	6	-	-	-	-	-	-	
new AFMRC-RD1204-D040-A16-Z04-H	●	40	4	40	40	6	RD.. 1204	4015-M4.5x11	ACK-05	4015-M4x11	82-T08	2406-M8X30	
new AFMRC-RD1204-D042-A16-Z04-H	●	42	4	16	40	6						2508-M10X30	
AFMRC-RD1204-D050-A22-Z05-H	●	50	5	16	40	6						2510-M12X35	
AFMRC-RD1204-D052-A22-Z05-H	●	52	5	22	50	6						2514-M16x35	
AFMRC-RD1204-D063-A22-Z06-H	●	63	6	22	50	6						-	
AFMRC-RD1204-D080-A27-Z07-H	●	80	7	22	50	6						-	
AFMRC-RD1204-D100-A32-Z07-H	●	100	7	27	50	6	-	-	-	-	-	-	
AFMRC-RD1204-D100-A32-Z08-H	●	100	8	32	50	6	-	-	-	-	-	-	
AFMRC-RD1604-D050-A22-Z04-H	●	50	4	32	50	6	RD.. 1604	4015-M4.5x11	ACK-05	4015-M4x11	82-T08	2408-M10x30	
AFMRC-RD1604-D052-A22-Z04-H	●	52	4	22	50	8						2508-M10X30	
AFMRC-RD1604-D063-A22-Z05-H	●	63	5	22	50	8						2510-M12X35	
AFMRC-RD1604-D066-A22-Z05-H	●	66	5	22	50	8						2514-M16x35	
AFMRC-RD1604-D066-A27-Z05-H	●	66	5	22	50	8						-	
AFMRC-RD1604-D080-A27-Z06-H	●	80	6	27	50	8						-	
AFMRC-RD1604-D100-A32-Z07-H	●	100	7	27	50	8	-	-	-	-	-	-	
AFMRC-RD1604-D100-A32-Z08-H	●	100	8	32	50	8	-	-	-	-	-	-	
AFMRC-RD1604-D125-B40-Z07	●	125	7	32	50	8	-	-	-	-	-	-	
AFMRC-RD1604-D160-C40-Z08	●	160	8	40	63	8	-	-	-	-	-	-	

R: Sağ / Right / Правый L: Sol / Left / Левый

● Stokta / In Stock / В наличии ○ Stokta Yok / Non Stock Item / Нет в наличии

ISO Ucuna Uygunudur. / Compatible with ISO Insert. / Под пластину ISO

Sipariş Örneği/Ordering Example/Образец заказа

1 ad./pcs./шт. AFMR-RD0702-D050-A22-Z06-H

Kesme Hesabı : S 377 / Cutting Calculation : P 377 / Расчет режимов резания: стр. 377

Montaj Ölçüleri : S 374 / Mounting Reference : P 374 / Инструкция по установке фрез: стр. 374

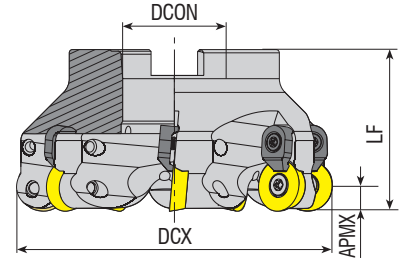
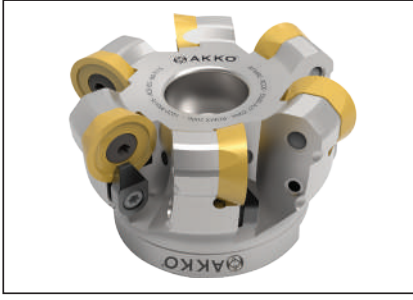

Takım Kodu Ordering Code Код для заказа	Stok Stock Наличие	Takım Ölçüleri (mm) Dimension (mm) Размеры (мм)					Kesici Uç Insert Пластина	Yedek Parçaları / Spare Parts / Запасные части				
		DC	ZEFP	DCON	LF	APMX		Sıkma Vidası Screw Зажимной винт	Baskı Parçası Wedge Clamp Прижим	Baskı Vidası Clamp Screw Зажимной винт	Tork Anahtar Torx Key Торх Ключ	Montaj Vidası Mounting Screw Монтажный винт
AFMRC-R020-D063-A22-Z05-H	●	63	5	22	50	10	ROMX 2006					
AFMRC-R020-D080-A27-Z06-H	●	80	6	27	50	10						

WLTR Ucuna Uygundur. / Compatible with WLTR Insert. / Под пластину WLTR.

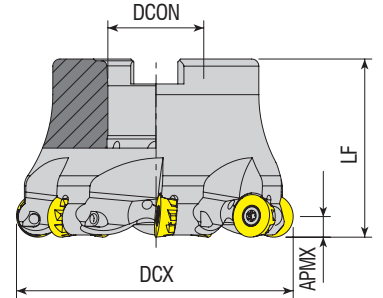

Takım Kodu Ordering Code Код для заказа	Stok Stock Наличие	Takım Ölçüleri (mm) Dimension (mm) Размеры (мм)					Kesici Uç Insert Пластина	Yedek Parçaları / Spare Parts / Запасные части		
		DCX	ZEFP	DCON	LF	APMX		Sıkma Vidası Screw Зажимной винт	Tork Anahtar Torx Key Торх Ключ	Montaj Vidası Mounting Screw Монтажный винт
AFMR-RP10T3-D063-A22-Z06-H	●	63	6	22	40	5	RPNX 10T3..			
AFMR-RP10T3-D080-A27-Z07-H	●	80	7	27	50	5				
AFMR-RP1204-D040-A16-Z04-H	●	40	4	16	40	6	RPNX 1204..			
AFMR-RP1204-D080-A27-Z07-H	●	80	7	27	50	6				

R: Sağ / Right / Правый L: Sol / Left / Левый

● Stokta / In Stock / В наличии ○ Stokta Yok / Non Stock Item / Нет в наличии

CRTZT Ucuna Uygundur. / Compatible with CRTZT Insert. / Под пластину CRTZT

Sipariş Örneği/Ordering Example/Образец заказа

1 ad./pcs./шт. AFMRC-R020-D063-A22-Z05-H

Kesme Hesabı : S 377 / Cutting Calculation : P 377 / Расчет режимов резания: стр. 377

Montaj Ölçüleri : S 374 / Mounting Reference : P 374 / Инструкция по установке фрез: стр. 374

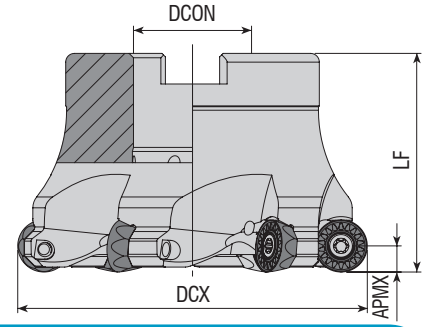

Takım Kodu Ordering Code Код для заказа	Stok Stock Наличие	Takım Ölçüleri (mm) Dimension (mm) Размеры (мм)					Kesici Uç Insert Пластина	Yedek Parçaları / Spare Parts / Запасные части			
		DCX	ZEP	DCON	LF	APMX		Sıkma Vidası Screw Зажимной винт	Tork Anahtar Torx Key Торх Ключ	Montaj Vidası Mounting Screw Монтажный винт	
new AFMR-RP1204M-D042-A16-Z04-H	●	42	4	16	40	6	RPMT 1204..			2406-M8x30	
AFMR-RP1204M-D050-A22-Z04-H	●	50	4	22	50	6					
AFMR-RP1204M-D052-A22-Z05-H	●	52	5	22	50	6					
AFMR-RP1204M-D063-A22-Z05-H	●	63	5	22	50	6					
AFMR-RP1204M-D080-A27-Z06-H	●	80	6	27	50	6					
										2508-M10x30	
										2510-M12x35	

MTSBH Ucuna Uygundur. / Compatible with MTSBH Insert. / Под пластину MTSBH

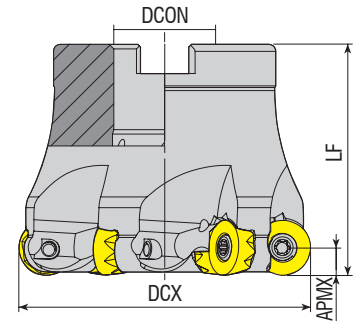

Takım Kodu Ordering Code Код для заказа	Stok Stock Наличие	Takım Ölçüleri (mm) Dimension (mm) Размеры (мм)					Kesici Uç Insert Пластина	Yedek Parçaları / Spare Parts / Запасные части			
		DCX	ZEP	DCON	LF	APMX		Sıkma Vidası Screw Зажимной винт	Tork Anahtar Torx Key Торх Ключ	Montaj Vidası Mounting Screw Монтажный винт	
AFMR-RY10-D040-A16-Z04-H	●	40	4	16	40	5	RYMX 1004..			2406-M8x30	
AFMR-RY10-D040-A16-Z05-H	●	40	5	16	40	5				2506-M8x30	
AFMR-RY10-D050-A22-Z05-H	●	50	5	22	50	5				2508-M10x30	
AFMR-RY10-D063-A22-Z06-H	●	63	6	22	50	5				80-T15	
AFMR-RY12-D040-A16-Z04-H	●	40	4	16	40	6				2406-M8x30	
AFMR-RY12-D050-A22-Z05-H	●	50	5	22	50	6	RYMX 1205..			2508-M10x30	
AFMR-RY12-D052-A22-Z05-H	●	52	5	22	50	6				2510-M12x35	
AFMR-RY12-D063-A22-Z06-H	●	63	6	22	50	6				2514-M16x35	
AFMR-RY12-D080-A27-Z06-H	●	80	6	27	50	6					
AFMR-RY12-D100-A32-Z07-H	●	100	7	32	50	6					

R: Sağ / Right / Правый L: Sol / Left / Левый

● Stokta / In Stock / В наличии ○ Stokta Yok / Non Stock Item / Нет в наличии

TGTC Ucuna Uygundur. / Compatible with TGTC Insert. / Под пластину TGTC

Sipariş Örneği/Ordering Example/Образец заказа

1 ad./pcs./шт. AFMR-RP1204M-D042-A16-Z04-H

Kesme Hesabı : S 377 / Cutting Calculation : P 377 / Расчет режимов резания: стр. 377

Montaj Ölçüleri : S 374 / Mounting Reference : P 374 / Инструкция по установке фрез: стр. 374

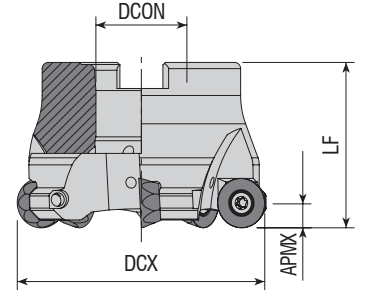

Takım Kodu Ordering Code Код для заказа	Stok Stock Наличие	Takım Ölçüleri (mm) Dimension (mm) Размеры (мм)					Kesici Uç Insert Пластина	Yedek Parçaları / Spare Parts / Запасные части		
		DCX	ZEFP	DCON	LF	APMX		Sıkma Vidası Screw Зажимной винт	Tork Anahtar Torx Key Торх Ключ	Montaj Vidası Mounting Screw Монтажный винт
AFMR-QP10T3-D040-A16-Z04-H	●	40	4	16	40	5	QP. 10T3..	4015-M3.5x11	80-T15	2506-M8x30
AFMR-QP10T3-D050-A22-Z05-H	●	50	5	22	40	5				2407-M10x30
AFMR-QP10T3-D063-A22-Z06-H	●	63	6	22	40	5				
AFMR-QP1204-D050-A22-Z04-H	●	50	4	22	40	6	QP. 1204..	4015-M4x11		
AFMR-QP1204-D063-A22-Z05-H	●	63	5	22	40	6				

SMTM Ucuna Uygundur. / Compatible with SMTM Insert. / Под пластину SMTM

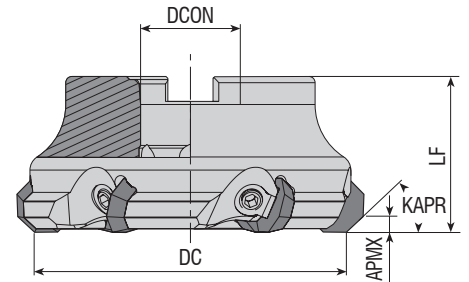

Takım Kodu Ordering Code Код для заказа	Stok Stock Наличие	Takım Ölçüleri (mm) Dimension (mm) Размеры (мм)					Kesici Uç Insert Пластина	Yedek Parçaları / Spare Parts / Запасные части			
		DC	ZEFP	DCON	LF	APMX		Baskı Parçası Wedge Clamp Прижим	Baskı Vidası Clamp Screw Зажимной винт	Anahtar Allen Key Ключ	Montaj Vidası Mounting Screw Монтажный винт
AFM43C-OF07-D063-A22-Z04	●	63	4	22	45	5	OF. 0704..	ACK-11	AKV-15-M8x1x20	AAL-05-4	2508-M10x30
AFM43C-OF07-D080-A27-Z05	●	80	5	27	50	5					2510-M12x35
AFM43C-OF07-D100-A32-Z06	●	100	6	32	50	5					2514-M16x35
AFM43C-OF07-D125-B40-Z08	●	125	8	40	63	5					
AFM43C-OF07-D160-C40-Z09	●	160	9	40	63	5					

R: Sağ / Right / Правый L: Sol / Left / Левый

● Stokta / In Stock / В наличии ○ Stokta Yok / Non Stock Item / Нет в наличии

ISO Ucuna Uygundur. / Compatible with ISO Insert. / Под пластину ISO

Sipariş Örneği/Ordering Example/Образец заказа

1 ad./pcs./шт. AFMR-QP10T3-D040-A16-Z04-H

Kesme Hesabı : S 377 / Cutting Calculation : P 377 / Расчет режимов резания: стр. 377

Montaj Ölçüleri : S 374 / Mounting Reference : P 374 / Инструкция по установке фрез: стр. 374

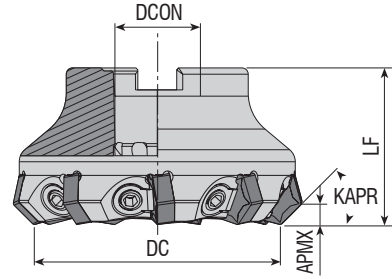

Takım Kodu Ordering Code Код для заказа	Stok Stock Наличие	Takım Ölçüleri (mm) Dimension (mm) Размеры (мм)					Kesici Uç Insert Пластина	Yedek Parçaları / Spare Parts / Запасные части								
		DC	ZEFP	DCON	LF	APMX		Baskı Parçası Wedge Clamp Прижим	Baskı Vidası Clamp Screw Зажимной винт	Anahtar Allen Key Ключ	Montaj Vidası Mounting Screw Монтажный винт					
AFM45C-HN0905-D063-A22-Z07	●	63	7	22	40	4.5										
AFM45C-HN0905-D080-A27-Z09	●	80	9	27	50	4.5										
AFM45C-HN0905-D100-A32-Z11	●	100	11	32	50	4.5						HN.. 0905..	ACK-11	AKV-15-M8x1x20	AAL-05-4	2508-M10x30
AFM45C-HN0905-D125-B40-Z13	●	125	13	40	63	4.5						2510-M12x35				
AFM45CL-HN0905-D125-B40-Z10	●	125	10	40	63	4.5						2514-M16x35				
AFM45C-HN0905-D160-C40-Z15	●	160	15	40	63	4.5						-				

WDA-KNMTL Ucuna Uygunur. / Compatible with WDA-KNMTL Insert. / Под пластину WDA-KNMTL

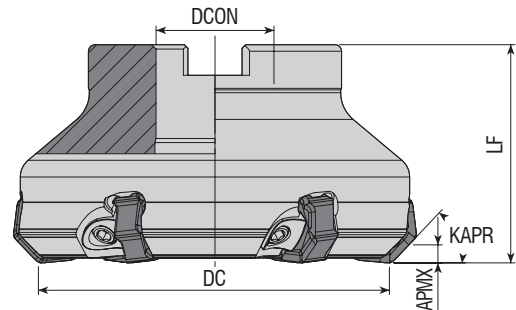

Takım Kodu Ordering Code Код для заказа	Stok Stock Наличие	Takım Ölçüleri (mm) Dimension (mm) Размеры (мм)					Kesici Uç Insert Пластина	Yedek Parçaları / Spare Parts / Запасные части								
		DC	ZEFP	DCON	LF	APMX		Baskı Parçası Wedge Clamp Прижим	Baskı Vidası Clamp Screw Зажимной винт	Anahtar Allen Key Ключ	Montaj Vidası Mounting Screw Монтажный винт					
AFM45C-XN0806-D063-A22-Z05	●	63	5	22	50	4.5										
AFM45C-XN0806-D080-A27-Z06	●	80	6	27	50	4.5										
AFM45C-XN0806-D100-A32-Z08	●	100	8	32	50	4.5						XN0806..	ACK-26	AKV-26-M6x0.75x20	AAL-03-03	2508-M10x30
AFM45C-XN0806-D125-B40-Z08	●	125	8	40	63	4.5						2510-M12x35				
AFM45C-XN0806-D160-C40-Z10	●	160	10	40	63	4.5						2514-M16x35				
AFM45C-XN0806-D200-C60-Z12	●	200	12	60	63	4.5						-				

R: Sağ / Right / Правый L: Sol / Left / Левый
● Stokta / In Stock / В наличии ○ Stokta Yok / Non Stock Item / Нет в наличии
DJT Ucuna Uygunur. / Compatible with DJT Insert. / Под пластину DJT.

Sipariş Örneği/Ordering Example/Образец заказа
1 ad./pcs./шт. AFM45C-HN0905-D063-A22-Z07

Kesme Hesabı : S 377 / Cutting Calculation : P 377 / Расчет режимов резания: стр. 377
Montaj Ölçüleri : S 374 / Mounting Reference : P 374 / Инструкция по установке фрез: стр. 374

KAPR=75°

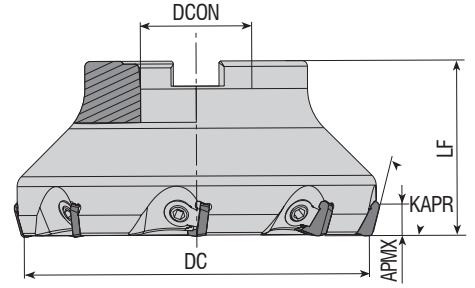

Takım Kodu Ordering Code Код для заказа	Stok Stock Наличие	Takım Ölçüleri (mm) Dimension (mm) Размеры (мм)					Kesici Uç Insert Пластина	Yedek Parçaları / Spare Parts / Запасные части			
		DC	ZEP	DCON	LF	APMX		Baskı Parçası Wedge Clamp Прижим	Baskı Vidası Clamp Screw Зажимной винт	Anahtar Allen Key Ключ	Montaj Vidası Mounting Screw Монтажный винт
AFM75C-SP12-D050-A22-Z04	●	50	4	22	42	8	SPKN 1203..	ACK-10	AKV-22-M8x1x14	AAL-05-4	2508-M10x30
AFM75C-SP12-D063-A22-Z05	●	63	5	22	40	8					
AFM75C-SP12-D080-A27-Z06	●	80	6	27	50	8					
AFM75C-SP12-D100-A32-Z07	●	100	7	32	50	8					
AFM75C-SP12-D125-B40-Z08	●	125	8	40	63	8					
AFM75C-SP12-D160-C40-Z09	●	160	9	40	63	8					
AFM75C-SP12-D200-C60-Z12	●	200	12	60	63	8					

ISO Ucuna Uygundur. / Compatible with ISO Insert. / Под пластину ISO

KAPR=88°

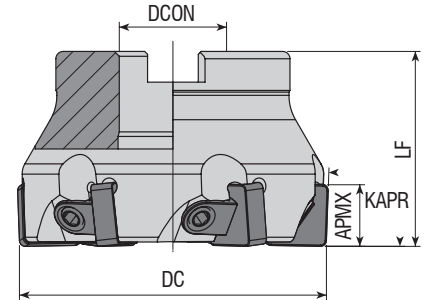

Takım Kodu Ordering Code Код для заказа	Stok Stock Наличие	Takım Ölçüleri (mm) Dimension (mm) Размеры (мм)					Kesici Uç Insert Пластина	Yedek Parçaları / Spare Parts / Запасные части			
		DC	ZEP	DCON	LF	APMX		Baskı Parçası Wedge Clamp Прижим	Baskı Vidası Clamp Screw Зажимной винт	Anahtar Allen Key Ключ	Montaj Vidası Mounting Screw Монтажный винт
AFM88C-SN1204-D050-A22-Z05	●	50	5	22	40	11	SN.. 1204..	ACK-21	AKV-24-M6x1x18	AAL-03-3	2408-M10x30
AFM88C-SN1204-D063-A22-Z06	●	63	6	22	40	11					
AFM88C-SN1204-D080-A27-Z07	●	80	7	27	50	11					
AFM88C-SN1204-D100-A32-Z08	●	100	8	32	50	11					
AFM88C-SN1204-D125-B40-Z11	●	125	11	40	63	11					

R: Sağ / Right / Правый L: Sol / Left / Левый

● Stokta / In Stock / В наличии ○ Stokta Yok / Non Stock Item / Нет в наличии

UNIN-NT-KYCR Ucuna Uygundur. / Compatible with UNIN-NT-KYCR Insert. / Под пластину UNIN-NT-KYCR

Sipariş Örneği/Ordering Example/Образец заказа

1 ad./pcs./шт. AFM75C-SP12-D050-A22-Z04

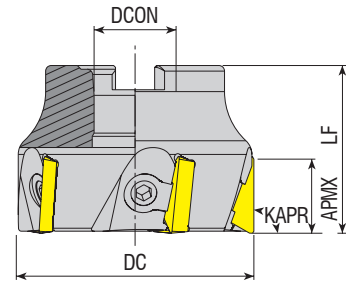

Codice D'ordine Ordering Code Код для заказа	Stok Stock Наличие	Takım Ölçüleri (mm) Dimension (mm) Размеры (мм)					Kesici Uç Insert Пластина	Yedek Parçaları / Spare Parts / Запасные части			
		DC	ZEFP	DCON	LF	APMX		Baskı Parçası Wedge Clamp Прижим	Baskı Vidası Clamp Screw Зажимной винт	Anahtar Allen Key Ключ	Montaj Vidası Mounting Screw Монтажный винт
AFM90C-TP16-D050-A22-Z04	●	50	4	22	40	12	TP. 1603..	ACK-10	AKV-22-M8x1x14 AKV-13-M8x1x16	AAL-05-4	2407-M10x30 2508-M10x30 2510-M12x35 2514-M16x35
AFM90C-TP16-D063-A22-Z06	●	63	6	22	45	12					
AFM90C-TP16-D080-A27-Z07	●	80	7	27	50	12					
AFM90C-TP16-D100-A32-Z08	●	100	8	32	50	12					
AFM90C-TP16-D125-B40-Z08	●	125	8	40	63	12					
AFM90C-TP22-D063-A22-Z05	●	63	5	22	45	18	TP. 2204..	ACK-11	AKV-14-M8x1x18	2508-M10x30 2510-M12x35 2514-M16x35	
AFM90C-TP22-D080-A27-Z06	●	80	6	27	50	18					
AFM90C-TP22-D100-A32-Z07	●	100	7	32	50	18					
AFM90C-TP22-D125-B40-Z08	●	125	8	40	63	18					
AFM90C-TP22-D160-C40-Z09	●	160	9	40	63	18					
AFM90C-TP22-D200-C60-Z12	●	200	12	60	63	18					
AFM90C-TP22-D250-C60-Z15	●	250	15	60	63	18					
AFM90C-TP22-D315-D60-Z18	●	315	18	60	63	18					

ISO Ucuna Uygundur. / Compatible with ISO Insert. / Под пластину ISO

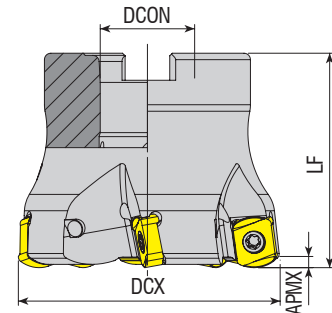

Takım Kodu Ordering Code Код для заказа	Stok Stock Наличие	Takım Ölçüleri (mm) Dimension (mm) Размеры (мм)					Kesici Uç Insert Пластина	Yedek Parçaları / Spare Parts / Запасные части		
		DCX	ZEFP	DCON	LF	APMX		Sıkma Vidası Screw Зажимной винт	Tork Anahtar Torx Key Торх Ключ	Montaj Vidası Mounting Screw Монтажный винт
AHFM-BL0603-D040-A16-Z06-H	●	40	6	16	40	1	BLMP 0603..	3008-M2.5x6	82-T08	2506-M8x30
AHFM-BL0603-D050-A22-Z07-H	●	50	7	22	50	1				
AHFM-BL0904-D040-A16-Z05-H	●	40	5	16	40	2				
AHFM-BL0904-D050-A22-Z06-H	●	50	6	22	50	2	BLMP 0904..	3010-M3.5x9	82-T10	2508-M10x30
AHFM-BL0904-D063-A22-Z05-H	●	63	5	22	50	2				
AHFM-BL0904-D063-A22-Z07-H	●	63	7	22	50	2				

R: Sağ / Right / Правый L: Sol / Left / Левый

● Stokta / In Stock / В наличии ○ Stokta Yok / Non Stock Item / Нет в наличии

DJT Ucuna Uygundur. / Compatible with DJT Insert. / Под пластину TGTC.

Sipariş Örneği/Ordering Example/Образец заказа 1 ad./pcs./шт. AHFM-EP1003-D050-A22-Z08-H

Kesme Hesabı : S 377 / Cutting Calculation : P 377 / Расчет режимов резания: стр. 377

Montaj Ölçüleri : S 374 / Mounting Reference : P 374 / Инструкция по установке фрез: стр. 374

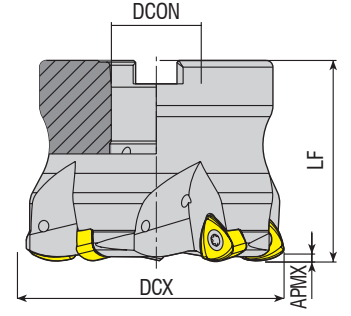

Takım Kodu Ordering Code Код для заказа	Stok Stock Наличие	Takım Ölçüleri (mm) Dimension (mm) Размеры (мм)					Kesici Uç Insert Пластина	Yedek Parçaları / Spare Parts / Запасные части		
		DCX	ZEFP	DCON	LF	APMX		Sıkma Vidası Screw Зажимной винт	Tork Anahtar Torx Key Торх Ключ	Montaj Vidası Mounting Screw Монтажный винт
AHFM-BL1205-D050-A22-Z03-H	●	50	3	22	40	2	BLMP 1205..	4015-M4x11	80-T15	2508-M10x30
AHFM-BL1205-D063-A22-Z04-H	●	63	4	22	40	2				
AHFM-BL1205-D080-A27-Z05-H	●	80	5	27	50	2				2510-M12x35

TGTC Ucuna Uygunudur. / Compatible with TGTC Insert. / Под пластину TGTC

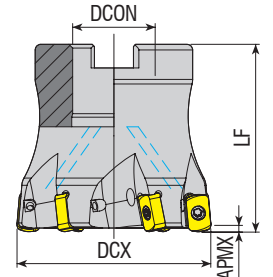

Takım Kodu Ordering Code Код для заказа	Stok Stock Наличие	Takım Ölçüleri (mm) Dimension (mm) Размеры (мм)					Kesici Uç Insert Пластина	Yedek Parçaları / Spare Parts / Запасные части		
		DCX	ZEFP	DCON	LF	APMX		Sıkma Vidası Screw Зажимной винт	Tork Anahtar Torx Key Торх Ключ	Montaj Vidası Mounting Screw Монтажный винт
AHFM-EN1004-D050-A22-Z05-H	●	50	5	22	50	1	ENMU 1004..	3008-M2.5X6	82-T08	2508-M10x30
AHFM-EN1004-D050-A22-Z06-H	●	50	6	22	50	1				
AHFM-EN1004-D052-A22-Z06-H	●	52	6	22	50	1				
AHFM-EN1004-D063-A22-Z06-H	●	63	6	22	50	1				

R: Sağ / Right / Правый L: Sol / Left / Левый
● Stokta / In Stock / В наличии ○ Stokta Yok / Non Stock Item / Нет в наличии
DJT Ucuna Uygunudur. / Compatible with DJT Insert. / Под пластину DJT

Sipariş Örneği/Ordering Example/Образец заказа
1 ad./pcs./шт. AHFM-BL1205-D050-A22-Z03-H

Kesme Hesabı : S 377 / Cutting Calculation : P 377 / Расчет режимов резания: стр. 377
Montaj Ölçüleri : S 374 / Mounting Reference : P 374 / Инструкция по установке фрез: стр. 374

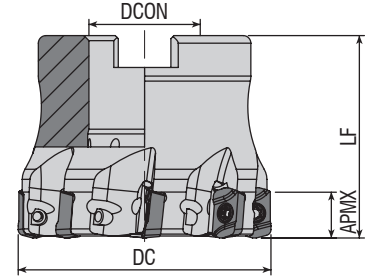

Takım Kodu Ordering Code Код для заказа	Stok Stock Наличие	Takım Ölçüleri (mm) Dimension (mm) Размеры (мм)					Kesici Uç Insert Пластина	Yedek Parçaları / Spare Parts / Запасные части		
		DC	ZEFP	DCON	LF	APMX		Sıkma Vidası Screw Зажимной винт	Tork Anahtar Torx Key Торх Ключ	Montaj Vidası Mounting Screw Монтажный винт
AHFM-EP1003-D050-A22-Z08-H	●	50	8	22	40	1				
AHFM-EP1003-D063-A22-Z08-H	●	63	8	22	40	1				

DJT Ucuna Uygundur. / Compatible with DJT Insert. / Под пластину DJT

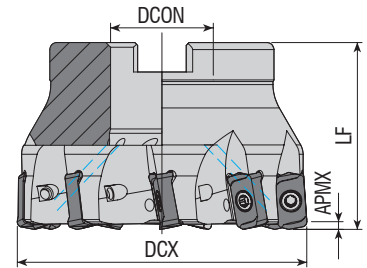

Takım Kodu Ordering Code Код для заказа	Stok Stock Наличие	Takım Ölçüleri (mm) Dimension (mm) Размеры (мм)					Kesici Uç Insert Пластина	Yedek Parçaları / Spare Parts / Запасные части					
		DCX	ZEFP	DCON	LF	APMX		Sıkma Vidası Screw Зажимной винт	Tork Anahtar Torx Key Торх Ключ	Montaj Vidası Mounting Screw Монтажный винт			
AHFM-L003-D040-A16-Z06-H	●	40	6	16	40	1				2506-M8x30			
AHFM-L003-D050-A22-Z07-H	●	50	7	22	40	1				LOGU 0303..	1108-M3x6.8	82-T08	2508-M10x30
AHFM-L003-D063-A22-Z09-H	●	63	9	22	40	1							

KYCR Ucuna Uygundur. / Compatible with KYCR Insert. / Под пластину KYCR

Sipariş Örneği/Ordering Example/Образец заказа
1 ad./pcs./шт. AHFM-EP1003-D050-A22-Z08-H

Kesme Hesabı : S 377 / Cutting Calculation : P 377 / Расчет режимов резания: стр. 377
Montaj Ölçüleri : S 374 / Mounting Reference : P 374 / Инструкция по установке фрез: стр. 374

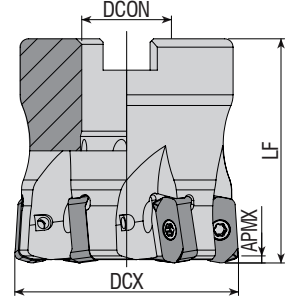

Takım Kodu Ordering Code Код для заказа	Stok Stock Наличие	Takım Ölçüleri (mm) Dimension (mm) Размеры (мм)					Kesici Uç Insert Пластина	Yedek Parçaları / Spare Parts / Запасные части					
		DCX	ZEFP	DCON	LF	APMX		Sıkma Vidası Screw Зажимной винт	Tork Anahtar Torx Key Торх Ключ	Montaj Vidası Mounting Screw Монтажный винт			
AHFM-LN0303-D040-A16-Z06-H	●	40	6	16	40	12	LNMU 0303..				2506-M8x30		
AHFM-LN0303-D050-A22-Z07-H	●	50	7	22	50	12					3008-M2.5X6	82-T08	2508-M10x30
AHFM-LN0303-D063-A22-Z09-H	●	63	9	22	50	12							

TNGYL Ucuna Uygundur. / Compatible with TNGYL Insert. / Под пластину TNGYL

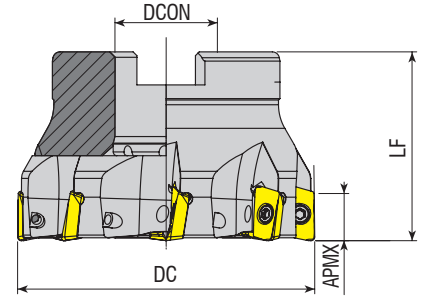

Takım Kodu Ordering Code Код для заказа	Stok Stock Наличие	Takım Ölçüleri (mm) Dimension (mm) Размеры (мм)					Kesici Uç Insert Пластина	Yedek Parçaları / Spare Parts / Запасные части			
		DC	ZEFP	DCON	LF	APMX		Sıkma Vidası Screw Зажимной винт	Tork Anahtar Torx Key Торх Ключ	Montaj Vidası Mounting Screw Монтажный винт	
AHFM-JD1003-D040-A16-Z06-H	●	40	6	16	40	9	JDMT 1003..				2506-M8x30
AHFM-JD1003-D063-A22-Z08-H	●	63	8	22	40	9					3008-M2.5x6

HTCH Ucuna Uygundur. / Compatible with HTCH Insert. / Под пластину HTCH

Sipariş Örneği/Ordering Example/Образец заказа

1 ad./pcs./шт. AHFM-LN0303-D040-A16-Z06-H

Kesme Hesabı : S 377 / Cutting Calculation : P 377 / Расчет режимов резания: стр. 377

Montaj Ölçüleri : S 374 / Mounting Reference : P 374 / Инструкция по установке фрез: стр. 374

new

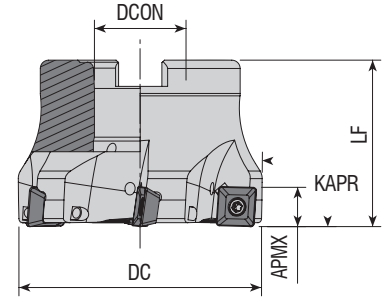

Takım Kodu Ordering Code Код для заказа	Stok Stock Наличие	Takım Ölçüleri (mm) Dimension (mm) Размеры (мм)					Kesici Uç Insert Пластина	Yedek Parçaları / Spare Parts / Запасные части			
		DC	ZEFP	DCON	LF	APMX		Sıkma Vidası Screw Зажимной винт	Tork Anahtar Torx Key Торх Ключ	Montaj Vidası Mounting Screw Монтажный винт	
AHFM-SP0945-D050-A22-Z06-H	●	50	6	22	40	1.4					
AHFM-SP0945-D052-A22-Z06-H	●	52	6	22	40	1.4					SPMX 0945..

MTSBH Ucuna Uygunur. / Compatible with MTSBH Insert. / Под пластину MTSBH.

new

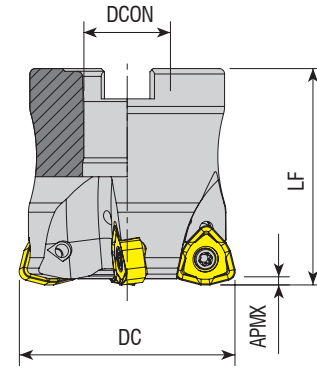

Takım Kodu Ordering Code Код для заказа	Stok Stock Наличие	Takım Ölçüleri (mm) Dimension (mm) Размеры (мм)					Kesici Uç Insert Пластина	Yedek Parçaları / Spare Parts / Запасные части			
		DC	ZEFP	DCON	LF	APMX		Sıkma Vidası Screw Зажимной винт	Tork Anahtar Torx Key Торх Ключ	Montaj Vidası Mounting Screw Монтажный винт	
AHFM-J009-D050-A22-Z04-H	●	50	4	22	50	1.2					
AHFM-J009-D063-A22-Z05-H	●	63	5	22	50	1.2					JOMU 0905..

MTSBH Ucuna Uygunur. / Compatible with MTSBH Insert. / Под пластину MTSBH.

Sipariş Örneği/Ordering Example/Образец заказа
1 ad./pcs./шт. AHFM-SP0945-D050-A22-Z06-H
Kesme Hesabı : S 377 / Cutting Calculation : P 377 / Расчет режимов резания: стр. 377

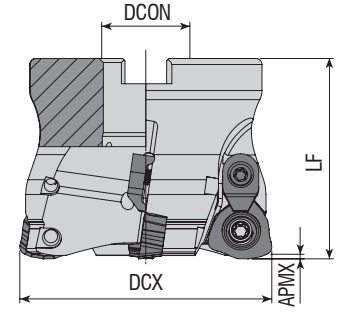

Takım Kodu Ordering Code Код для заказа	Stok Stock Наличие	Takım Ölçüleri (mm) Dimension (mm) Размеры (мм)					Kesici Uç Insert Пластина	Sıkma Vidası Screw Зажимной винт	Baskı Pabucu Wedge Clamp Прижим	Baskı Vidası Clamp Screw Зажимной винт	Tork Anahtar Torx Key Торх Ключ	Montaj Vidası Mounting Screw Монтажный винт
		DCX	ZEFP	DCON	LF	APMX						
AHFMC-JD1204-D052-A22-Z03-H	●	52	3	22	50	1.5	JDMW 1204..	4615-M4x11	ACK-05	4015-M4x11	80-T15	2508-M10x30
AHFMC-JD1204-D052-A22-Z04-H	●	52	4	22	50	1.5						
AHFMC-JD1204-D063-A22-Z05-H	●	63	5	22	50	1.5						
AHFMC-JD1204-D080-A27-Z06-H	●	80	6	27	50	1.5						
AHFMC-JD1204-D100-A32-Z07-H	●	100	7	32	50	1.5						
AHFMC-JD1405-D052-A22-Z03-H	●	52	3	22	40	2	JDMW 1405..	1020-M5x11		80-T20	2408-M10x30	
AHFMC-JD1405-D063-A22-Z04-H	●	63	4	22	40	2					2508-M10x30	

MTSBH Ucuna Uygunur. / Compatible with MTSBH Insert. / Под пластину MTSBH

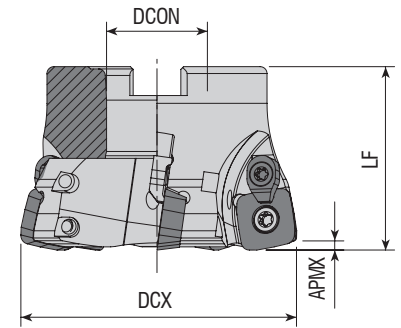

Takım Kodu Ordering Code Код для заказа	Stok Stock Наличие	Takım Ölçüleri (mm) Dimension (mm) Размеры (мм)					Kesici Uç Insert Пластина	Sıkma Vidası Screw Зажимной винт	Baskı Pabucu Wedge Clamp Прижим	Baskı Vidası Clamp Screw Зажимной винт	Tork Anahtar Torx Key Торх Ключ	Montaj Vidası Mounting Screw Монтажный винт
		DCX	ZEFP	DCON	LF	APMX						
AHFMC-SD1204-D050-A22-Z04-H	●	50	4	22	40	1.8	SD.. 1204..	4015-M4x11	ACK-15	4015-M3.5x11	80-T15	2508-M10x30
AHFMC-SD1204-D063-A22-Z05-H	●	63	5	22	40	1.8						
AHFMC-SD1204-D080-A27-Z06-H	●	80	6	27	50	1.8						
AHFMC-SD1204-D100-A32-Z08-H	●	100	8	32	50	1.8						

ZCC Ucuna Uygunur. / Compatible with ZCC Insert. / Под пластину ZCC





Sipariş Örneği/Ordering Example/Образец заказа

1 ad./pcs./шт. AHFMC-JD1204-D052-A22-Z03-H

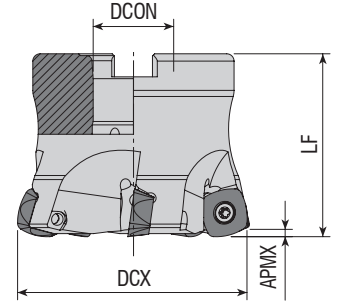
Kesme Hesabı : S 377 / Cutting Calculation : P 377 / Расчет режимов резания: стр. 377





Montaj Ölçüleri : S 374 / Mounting Reference : P 374 / Инструкция по установке фрез: стр. 374

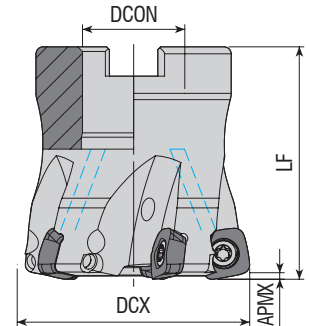

Takım Kodu Ordering Code Код для заказа	Stok Stock Наличие	Takım Ölçüleri (mm) Dimension (mm) Размеры (мм)					Kesici Uç Insert Пластина	Yedek Parçaları / Spare Parts / Запасные части						
		DCX	ZEFP	DCON	LF	APMX		Sıkma Vidası Screw Зажимной винт	Tork Anahtar Torx Key Торх Ключ	Montaj Vidası Mounting Screw Монтажный винт				
AHFM-SD1205-D052-A22-Z04-H	●	52	4	22	50	2								
AHFM-SD1205-D052-A22-Z05-H	●	52	5	22	50	2								
new AHFM-SD1205-D063-A22-Z05-H	●	63	5	22	50	2					SD.. 1205..	4015-M4x11	80-T15	2508-M10x30
AHFM-SD1205-D066-A22-Z05-H	●	66	5	22	50	2								
AHFM-SD1205-D066-A22-Z06-H	●	66	6	22	50	2								
AHFM-SD1205-D080-A27-Z06-H	●	80	6	27	70	2								2510-M12x35

HTCH Ucuna Uygun. / Compatible with HTCH Insert. / Под пластину HTCH



Takım Kodu Ordering Code Код для заказа	Stok Stock Наличие	Takım Ölçüleri (mm) Dimension (mm) Размеры (мм)					Kesici Uç Insert Пластина	Yedek Parçaları / Spare Parts / Запасные части						
		DCX	ZEFP	DCON	LF	APMX		Sıkma Vidası Screw Зажимной винт	Tork Anahtar Torx Key Торх Ключ	Montaj Vidası Mounting Screw Монтажный винт				
AHFM-SO1004-D050-A22-Z05-H	●	50	5	22	50	1.5								
AHFM-SO1004-D063-A22-Z06-H	●	63	6	22	50	1.5					SOMT 1004..	4015-M4x11	80-T15	2508-M10x30
AHFM-SO1004-D080-A27-Z07-H	●	80	7	27	63	1.5								2510-M12x35

KYCR Ucuna Uygun. / Compatible with KYCR Insert. / Под пластину KYCR

Sipariş Örneği/Ordering Example/Образец заказа
1 ad./pcs./шт. AHFM-SD1205-D052-A22-Z04-H

Kesme Hesabı : S 377 / Cutting Calculation : P 377 / Расчет режимов резания: стр. 377
Montaj Ölçüleri : S 374 / Mounting Reference : P 374 / Инструкция по установке фрез: стр. 374

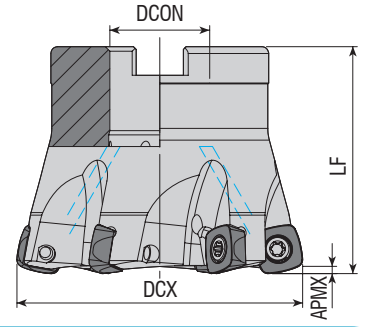

Takım Kodu Ordering Code Код для заказа	Stok Stock Наличие	Takım Ölçüleri (mm) Dimension (mm) Размеры (мм)					Kesici Uç Insert Пластина	Yedek Parçaları / Spare Parts / Запасные части			
		DCX	ZEPF	DCON	LF	APMX		Sıkma Vidası Screw Зажимной винт	Tork Anahtar Torx Key Торх Ключ	Montaj Vidası Mounting Screw Монтажный винт	
AHFM-SP1004-D050-A22-Z05-H	●	50	5	22	50	1.5	SPNW 1004..				
AHFM-SP1004-D052-A22-Z05-H	●	52	5	22	50	1.5					
AHFM-SP1004-D063-A22-Z06-H	●	63	6	22	50	1.5					

DJT Ucuna Uygundur. / Compatible with DJT Insert. / Под пластину DJT

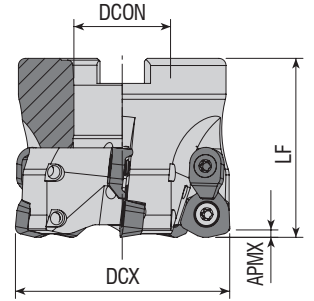
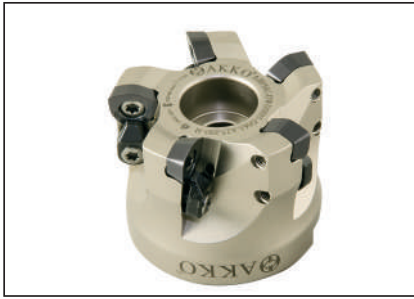

Takım Kodu Ordering Code Код для заказа	Stok Stock Наличие	Takım Ölçüleri (mm) Dimension (mm) Размеры (мм)					Kesici Uç Insert Пластина	Yedek Parçaları / Spare Parts / Запасные части				
		DCX	ZEPF	DCON	LF	APMX		Sıkma Vidası Screw Зажимной винт	Baskı Pabucu Wedge Clamp Прижим	Baskı Vidası Clamp Screw Зажимной винт	Tork Anahtar Torx Key Торх Ключ	Montaj Vidası Mounting Screw Монтажный винт
AHFMC-WD06T3D-D042-A16-Z04-H	●	42	4	16	45	1.5	WD.W 06T3..					
AHFMC-WD06T3D-D050-A22-Z05-H	●	50	5	22	50	1.5						
AHFMC-WD06T3D-D052-A22-Z05-H	●	52	5	22	50	1.5						
AHFMC-WD06T3D-D063-A22-Z06-H	●	63	6	22	50	1.5	WD.W 0805..					
AHFMC-WD0805D-D052-A22-Z04-H	●	52	4	22	50	2						
AHFMC-WD0805D-D063-A22-Z05-H	●	63	5	22	50	2						
AHFMC-WD0805D-D063-A27-Z05-H	●	63	5	27	50	2						
AHFMC-WD0805D-D066-A27-Z05-H	●	66	5	27	50	2						
AHFMC-WD0805D-D080-A27-Z05	●	80	5	27	50	2						
AHFMC-WD0805D-D100-A32-Z06	●	100	6	32	50	2						
AHFMC-WD10X6D-D125-B40-Z06	●	125	6	40	63	2.5						
AHFMC-WD10X6D-D160-C40-Z07	●	160	7	40	63	2.5						

DJT Ucuna Uygundur. / Compatible with DJT Insert. / Под пластину DJT

Sipariş Örneği/Ordering Example/Образец заказа

1 ad./pcs./шт. AHFM-SP1004-D050-A22-Z05-H

Kesme Hesabı : S 377 / Cutting Calculation : P 377 / Расчет режимов резания: стр. 377

Montaj Ölçüleri : S 374/ Mounting Reference : P 374 / Инструкция по установке фрез: стр. 374

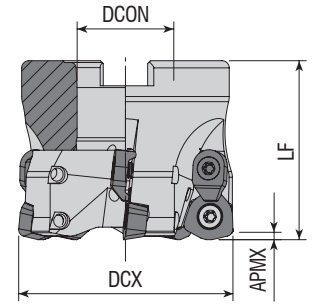

Takım Kodu Ordering Code Код для заказа	Stok Stock Наличие	Takım Ölçüleri (mm) Dimension (mm) Размеры (мм)					Kesici Uç Insert Пластина	Yedek Parçaları / Spare Parts / Запасные части				
		DCX	ZEFP	DCON	LF	APMX		Sıkma Vidası Screw Зажимной винт	Baskı Pabucu Wedge Clamp Прижим	Baskı Vidası Clamp Screw Зажимной винт	Tork Anahtar Torx Key Торх Ключ	Montaj Vidası Mounting Screw Монтажный винт
AHFMC-WD0804-D040-A16-Z04-H	●	40	4	16	40	1.5	WDMT 0804..	4010-M3x8	ACK-15	4010-M3x8	82-T10	2506-M8x30
AHFMC-WD0804-D050-A22-Z04-H	●	50	4	22	50	1.5						
AHFMC-WD1205-D050-A22-Z04-H	●	50	4	22	50	3	WDMT 1205..	1415-M4x11	ACK-05	4015-M4x11	80-T15	2508-M10x30
AHFMC-WD1205-D052-A22-Z04-H	●	52	4	22	50	3						
AHFMC-WD1205-D063-A22-Z05-H	●	63	5	22	50	3						
AHFMC-WD1205-D080-A27-Z06-H	●	80	6	27	63	3						

SMTM Ucuna Uygun. / Compatible with SMTM Insert. / Под пластину SMTM

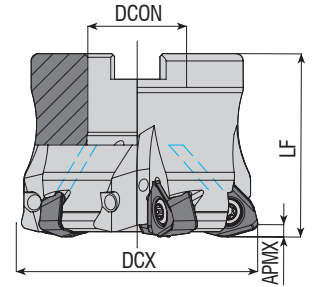

Takım Kodu Ordering Code Код для заказа	Stok Stock Наличие	Takım Ölçüleri (mm) Dimension (mm) Размеры (мм)					Kesici Uç Insert Пластина	Yedek Parçaları / Spare Parts / Запасные части				
		DCX	ZEFP	DCON	LF	APMX		Sıkma Vidası Screw Зажимной винт	Tork Anahtar Torx Key Торх Ключ	Montaj Vidası Mounting Screw Монтажный винт		
AHFMC-WD0804-D040-A16-Z04-H	●	40	4	16	40	1.5	WDMT 0804..	4010-M3x8	ACK-15	4010-M3x8	82-T10	2506-M8x30
AHFMC-WD0804-D050-A22-Z04-H	●	50	4	22	50	1.5						
AHFMC-WD1205-D050-A22-Z04-H	●	50	4	22	50	3	WDMT 1205..	1415-M4x11	ACK-05	4015-M4x11	80-T15	2508-M10x30
AHFMC-WD1205-D052-A22-Z04-H	●	52	4	22	50	3						
AHFMC-WD1205-D063-A22-Z05-H	●	63	5	22	50	3						
AHFMC-WD1205-D080-A27-Z06-H	●	80	6	27	63	3						
AHFMC-WD1205-D100-A32-Z07-H	●	100	7	32	100	3						

DJT Ucuna Uygun. / Compatible with DJT Insert. / Под пластину DJT

Sipariş Örneği/Ordering Example/Образец заказа
1 ad./pcs./шт. AHFMC-WD0804-D040-A16-Z04-H

Kesme Hesabı : S 377 / Cutting Calculation : P 377 / Расчет режимов резания: стр. 377
Montaj Ölçüleri : S 374 / Mounting Reference : P 374 / Инструкция по установке фрез: стр. 374

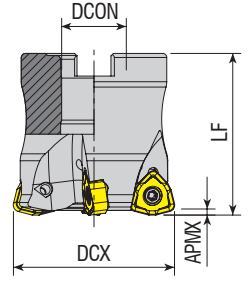

Takım Kodu Ordering Code Код для заказа	Stok Stock Наличие	Takım Ölçüleri (mm) Dimension (mm) Размеры (мм)					Kesici Uç Insert Пластина	Yedek Parçaları / Spare Parts / Запасные части		
		DCX	ZEFP	DCON	LF	APMX		Sıkma Vidası Screw Зажимной винт	Tork Anahtar Torx Key Торх Ключ	Montaj Vidası Mounting Screw Монтажный винт
AHFM-WN09T3-D040-A16-Z04-H	●	40	4	16	40	1.5	WVMX 09T3..	4010-M3x8	82-T10	2506-M8x30
AHFML-WN09T3-D040-A16-Z04-H	●	40	4	16	40	1.5				
AHFM-WN09T3-D050-A22-Z05-H	●	50	5	22	40	1.5				
AHFML-WN09T3-D050-A22-Z05-H	●	50	5	22	40	1.5				
AHFM-WN09T3-D063-A22-Z06-H	●	63	6	22	40	1.5				2508-M10x30

R: Sağ / Right / Правый L: Sol / Left / Левый
● Stokta / In Stock / В наличии ○ Stokta Yok / Non Stock Item / Нет в наличии
KRLY Ucuna Uygundur. / Compatible with KRLY Insert. / Под пластину KRLY

Sipariş Örneği/Ordering Example/Образец заказа
1 ad./pcs./шт. AHFM-WN09T3-D040-A16-Z04-H
Kesme Hesabı : S 377 / Cutting Calculation : P 377 / Расчет режимов резания: стр. 377
Montaj Ölçüleri : S 374/ Mounting Reference : P 374 / Инструкция по установке фрез: стр. 374



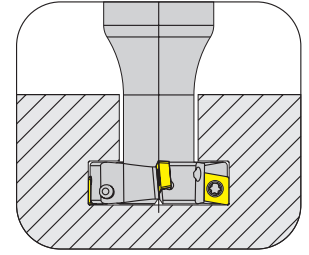
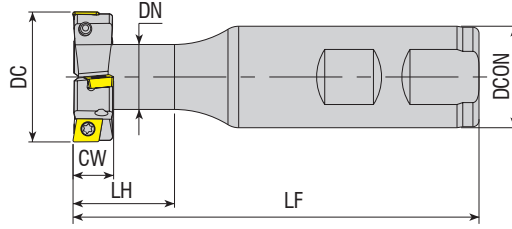

Takım Kodu
Ordering Code
Код для заказа

Stok
Stock
Наличие

Takım Ölçüleri (mm)
Dimension (mm)
Размеры (мм)

Kesici Uç
Insert
Пластина

Yedek Parçaları / Spare Parts / Запасные части

Sıkma Vidası
Screw
Зажимной винт

Tork Anahtar
Torx Key
Торх Ключ

	ZEFP		DC	CW	DCON	LF	DN	LH	Kesici Uç Insert Пластина	Sıkma Vidası Screw Зажимной винт	Tork Anahtar Torx Key Торх Ключ			
	Toplam Total Gesamt	Etkili Effective Effektiv												
ATSM90-CC06-D17X8-W16-L85-Z02	●	2	17	8	16	85	10	16	CC.T 0602..	3008-M2.5x6	82-T08			
ATSM90-CC06-D22X8-W20-L83-Z04	●	4	22	8	20	83	9	38						
ATSM90-CC06-D32X8-W25-L100-Z04	●	4	32	8	25	100	16	23						
ATSM90-CC06-D28X8-W20-L66-Z04	●	4	28	8	20	66	14	15.5						
ATSM90-CC06-D45.5X8-W25-L100-Z06	●	6	45.5	8	25	100	12	30						
ATSM90-CC06-D63X8-W32-L125-Z08	●	8	63	8	32	125	31.5	30						
ATSM90-CC06-D18X9-W16-L90-Z02	●	2	18	9	16	90	10	16						
ATSM90-CC06-D20X9-W16-L85-Z04	●	4	20	9	16	85	10	16						
ATSM90-CC06-D23X10-W20-L90-Z04	●	4	23	10	20	90	12	25						
ATSM90-CC06-D32X10-W25-L100-Z04	●	4	32	10	25	100	16	25						
ATSM90-CC06-D45X10-W32-L120-Z06	●	6	45	10	32	120	20	25						
ATSM90-CC06-D25X11-W25-L100-Z04	●	4	25	11	25	100	13	20						
ATSM90-CC09-D30X12-W25-L100-Z04	●	4	30	12	25	100	16	25				CC.T. 09T3..	4015-M3.5x9	80-T15
ATSM90-CC09-D32X12-W25-L100-Z02	●	2	32	12	25	100	16	25						
ATSM90-CC09-D32X12-W25-L100-Z04	●	4	32	12	25	100	16	25						
ATSM90-CC09-D32X14-W25-L100-Z04	●	4	32	14	25	100	16	25						
ATSM90-CC09-D37X16-W32-L120-Z04	●	4	37	16	32	120	17	30						
ATSM90-CC09-D40X17-W32-L120-Z04-H	●	4	40	17	32	120	19	30						
ATSM90-CC09-D42X17-W32-L120-Z04	●	4	42	17	32	120	19	30						
ATSM90-CC12-D47X20-W32-L120-Z04	●	4	47	20	32	120	25	45	CC.T 1204..	1020-M5x11	80-T20			
ATSM90-CC12-D52X21-W32-L120-Z04	●	4	52	21	32	120	25	45						
ATSM90-CC12-D50X22-W32-L120-Z04	●	4	50	22	32	120	25	45						
ATSM90-CC12-D55X22-W32-L120-Z04	●	4	55	22	32	120	25	45						

R: Sağ / Right / Правый L: Sol / Left / Левый

● Stokta / In Stock / В наличии ○ Stokta Yok / Non Stock Item / Нет в наличии

Sipariş Örneği/Ordering Example/Образец заказа

1 ad./pcs./шт. ATSM90-CC06-D17X8-W16-L85-Z02

Kesme Hesabı : S 367 / Cutting Calculation : P 367 / Расчет режимов резания: стр. 367



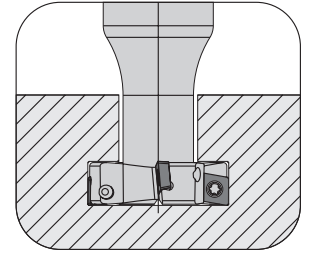
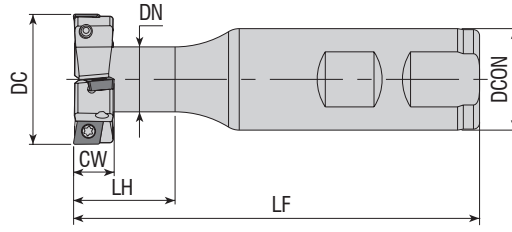

Takım Kodu Ordering Code Код для заказа	Stok Stock Наличие	Takım Ölçüleri (mm) Dimension (mm) Размеры (мм)							Kesici Uç Insert Пластина	Yedek Parçaları / Spare Parts / Запасные части		
		ZEFП		DC	CW	DCON	LF	DN		LH	Sıkma Vidası Screw Зажимной винт	Tork Anahtar Torx Key Торх Ключ
		Toplam Total Gesamt	Etkili Effective Effektiv									
ATSM90-SP.05-D22.5X5-W25-L100-Z04	●	4	2	22.5	5	25	100	12	25	SPMG 050204 TGTC UCUNA UYGUNDUR. FOR TGTC INSERT. Под пластину TGTC	3006-M2x4	82-T06
ATSM90-SP.05-D25X5-W25-L100-Z04	○	4	2	25	5	25	100	9	25			
ATSM90-SP.05-D30X5-W25-L100-Z04	●	4	2	30	5	25	100	10	25			
ATSM90-SPGT0502-D63X6-W32-L125-Z10	●	10	5	63	6	32	125	31	30	SPGT 050204		
ATSM90-SPGT0904-D32X14-W32-L120-Z04-H	●	4	2	32	14	32	120	17.5	30	SPGT 090408 ZCC UCUNA UYGUNDUR. FOR ZCC INSERT. Под пластину ZCC	4015-M3.5x9	80-T15
ATSM90-SPGT0904-D37X16-W32-L120-Z04-H	●	4	2	37	16	32	120	21	40			
ATSM90-SPGT0904-D42X17-W32-L120-Z04-H	●	4	2	42	17	32	120	21	40			
ATSM90-SPGT1104-D47X20-W32-L120-Z04-H	●	4	2	47	20	32	120	24	45	SPGT 110408	4015-M4x11	
ATSM90-SP.06-D80X7-W32-L120-Z10	●	10	5	80	7	32	120	32	30	SPMG 060204 TGTC UCUNA UYGUNDUR. FOR TGTC INSERT. Под пластину TGTC	3007-M2.2x4.6	82-T07

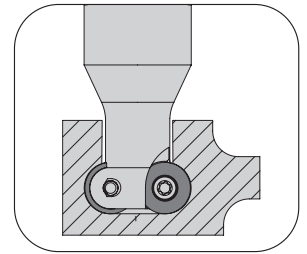
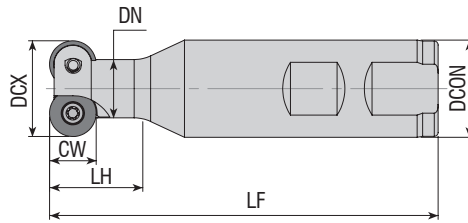

Takım Kodu Ordering Code Код для заказа	Stok Stock Наличие	Takım Ölçüleri (mm) Dimension (mm) Размеры (мм)							Kesici Uç Insert Пластина	Yedek Parçaları / Spare Parts / Запасные части	
		ZEFП	DCX	CW	DCON	LF	DN	LH		Sıkma Vidası Screw Зажимной винт	Tork Anahtar Torx Key Торх Ключ
ATSMR-RD0702-D17-W16-L90-Z02	●	2	17	7	16	90	10	12	RD.. 0702	3008-M2.5x6	82-T08
ATSMR-RD0702-D25-W16-L90-Z03	●	3	25	7	16	90	15	12			
ATSMR-RD0702-D35-W25-L100-Z05	●	5	35	7	25	100	20	20			
ATSMR-RD1003-D21-W25-L100-Z02	●	2	21	10	25	100	12	20	RD.. 1003	4015-M3.5x9	80-T15
ATSMR-RD1003-D80-W32-L165-Z06-H	●	6	80	10	32	165	30	31.5			
ATSMR-RD12T3-D25-W25-L100-Z02	●	2	25	12	25	100	15	24			
ATSMR-RD12T3-D80-W32-L165-Z06-H	●	6	80	12	32	165	30	31.5	RD.. 12T3		
ATSMR-RD1604-D34-W32-L110-Z02	●	2	34	16	32	110	20	30	RD.. 1604	4015-M4.5x11	

R: Sağ / Right / Правый L: Sol / Left / Левый

● Stokta / In Stock / В наличии ○ Stokta Yok / Non Stock Item / Нет в наличии
ISO Ucuna Uygun / Compatible with ISO Insert. / Под пластину ISO

Sipariş Örneği/Ordering Example/Образец заказа
1 ad./pcs./шт. ATSM90-SP.05-D22.5X5-W25-L100-Z04

Kesme Hesabı : S 367 / Cutting Calculation : P 367 / Расчет режимов резания: стр. 367

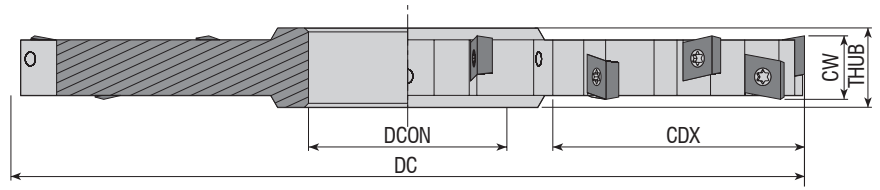

Takım Kodu
Ordering Code
Код для заказа

Takım Kodu Ordering Code Код для заказа	Stok Stock Наличие	Takım Ölçüleri (mm) Dimension (mm) Размеры (мм)						Kesici Uç Insert Пластина	Yedek Parçaları / Spare Parts / Запасные части		
		ZEFP		DC	CW	CDX	DCON		THUB	Sıkma Vidası Screw Зажимной винт	Tork Anahtar Torx Key Торх Ключ
		Toplam Total Gesamt	Etkili Effective Effektiv								
ASDM-SPGT05-D80x6-d27-Z10	●	10	5	80	6	17	27	10	SPGT 050204 ZCC UCUNA UYGUNDUR. FOR ZCC INSERT. Подплатину ZCC	3006-M2x4	82-T06
ASDM-SPGT05-D100x6-d32-Z12	●	12	6	100	6	25	32	10			
ASDM-SPGT05-D125x6-d40-Z14	●	14	7	125	6	35	40	10			
ASDM-SPGT05-D160x6-d40-Z18	●	18	9	160	6	52	40	10			
ASDM-SPGT06-D80x7-d27-Z10	●	10	5	80	7	17	27	11	SPGT 060204 ZCC UCUNA UYGUNDUR. FOR ZCC INSERT. Подплатину ZCC	3007-M2.2x4.6	82-T07
ASDM-SPGT06-D100x7-d32-Z12	●	12	6	100	7	25	32	11			
ASDM-SPGT06-D125x7-d40-Z14	●	14	7	125	7	35	40	11			
ASDM-SPGT06-D160x7-d40-Z16	●	16	8	160	7	52	40	11			
ASDM-SPGT06-D200x7-d40-Z18	●	18	9	200	7	70	40	11	SPGT 07T308	3008-M2.5x6	82-T08
ASDM-SPGT07-D100x10-d27-Z10	●	10	5	100	10	26.5	27	14			
ASDM-SPGT07-D100x10-d32-Z12	●	12	6	100	10	25	32	11			

R: Sağ / Right / Правый L: Sol / Left / Левый
● Stokta / In Stock / В наличии ○ Stokta Yok / Non Stock Item / Нет в наличии

Sipariş Örneği/Ordering Example/Образец заказа
1 ad./pcs./шт. ASDM-SPGT05-D80x6-d27-Z10
Kesme Hesabı : S 367 / Cutting Calculation : P 367 / Расчет режимов резания: стр. 367



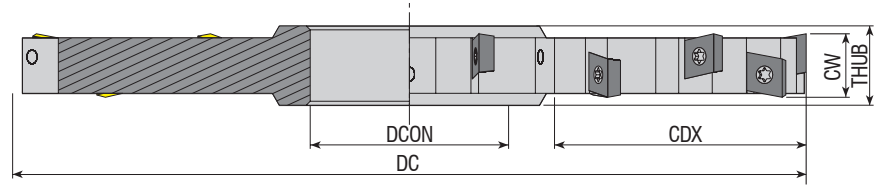

Takım Kodu
Ordering Code
Код для заказа

Stok
Stock
Наличие

ZEFP

Toplam
Total
Gesamt

Etkili
Effective
Effektiv

DC CW CDX DCON THUB

Takım Ölçüleri (mm)
Dimension (mm)
Размеры (мм)

Kesici Uç
Insert
Пластина

Yedek Parçaları / Spare Parts / Залпасные части

Sıkma Vidası
Screw
Зажимной винт

Tork Anahtar
Torx Key
Торх Ключ



Takım Kodu Ordering Code Код для заказа	Stok Stock Наличие	Takım Ölçüleri (mm) Dimension (mm) Размеры (мм)						Kesici Uç Insert Пластина	Yedek Parçaları / Spare Parts / Залпасные части		
		ZEFP		DC	CW	CDX	DCON		THUB	Sıkma Vidası Screw Зажимной винт	Tork Anahtar Torx Key Торх Ключ
		Toplam Total Gesamt	Etkili Effective Effektiv	DC	CW	CDX	DCON	THUB			
ASDM-CC06-D80x8-d27-Z10	●	10	5	80	8	17	27	12	CC.T 0602.. ISO UCUNA UYGUNDUR. FOR ISO INSERT. Под пластину ISO	3008-M2.5x6	82-T08
ASDM-CC06-D100x8-d32-Z12	●	12	6	100	8	25	32	12			
ASDM-CC06-D125x8-d40-Z14	●	14	7	125	8	35	40	12			
ASDM-CC06-D160x8-d40-Z16	●	16	8	160	8	52	40	12			
ASDM-CC06-D200x8-d40-Z18	●	18	9	200	8	70	40	12			
ASDM-CC06-D80x10-d27-Z10	●	10	5	80	10	17	27	14			
ASDM-CC06-D100x10-d32-Z12	●	12	6	100	10	25	32	14			
ASDM-CC06-D125x10-d40-Z14	●	14	7	125	10	35	40	14			
ASDM-CC06-D160x10-d40-Z16	●	16	8	160	10	52	40	14			
ASDM-CC06-D200x10-d40-Z18	●	18	9	200	10	70	40	14			
ASDM-CC09-D80x12-d27-Z08	●	8	4	80	12	17	27	16	CC.T 09T3.. ISO UCUNA UYGUNDUR. FOR ISO INSERT. Под пластину ISO	4015-M3.5x11	80-T15
ASDM-CC09-D100x12-d32-Z10	●	10	5	100	12	25	32	16			
ASDM-CC09-D125x12-d40-Z12	●	12	6	125	12	35	40	16			
ASDM-CC09-D160x12-d40-Z14	●	14	7	160	12	52	40	16			
ASDM-CC09-D200x12-d40-Z16	●	16	8	200	12	70	40	16			
ASDM-CC09-D80x14-d27-Z08	●	8	4	80	14	17	27	18			
ASDM-CC09-D100x14-d32-Z10	●	10	5	100	14	25	32	18			
ASDM-CC09-D125x14-d40-Z12	●	12	6	125	14	35	40	18			
ASDM-CC09-D160x14-d40-Z14	●	14	7	160	14	52	40	18			
ASDM-CC09-D200x14-d40-Z16	●	16	8	200	14	70	40	18			
ASDM-CC12-D80x16-d27-Z06	●	6	3	80	16	17	27	20	CC.T 1204.. ISO UCUNA UYGUNDUR. FOR ISO INSERT. Под пластину ISO	1020-M5x11	80-T20
ASDM-CC12-D100x16-d32-Z08	●	8	4	100	16	25	32	20			
ASDM-CC12-D125x16-d40-Z10	●	10	5	125	16	35	40	20			
ASDM-CC12-D160x16-d40-Z12	●	12	6	160	16	52	40	20			
ASDM-CC12-D200x16-d40-Z14	●	14	7	200	16	70	40	20			
ASDM-CC12-D80x18-d27-Z06	●	6	3	80	18	17	27	22			
ASDM-CC12-D100x18-d32-Z08	●	8	4	100	18	25	32	22			
ASDM-CC12-D125x18-d40-Z10	●	10	5	125	18	35	40	22			
ASDM-CC12-D160x18-d40-Z12	●	12	6	160	18	52	40	22			
ASDM-CC12-D200x18-d40-Z14	●	14	7	200	18	70	40	22			
ASDM-CC12-D250x18-d40-Z16	●	16	8	250	18	90	40	22			
ASDM-CC12-D80x20-d27-Z06	●	6	3	80	20	17	27	24			
ASDM-CC12-D100x20-d32-Z08	●	8	4	100	20	25	32	24			
ASDM-CC12-D125x20-d40-Z10	●	10	5	125	20	35	40	24			
ASDM-CC12-D160x20-d40-Z12	●	12	6	160	20	52	40	24			
ASDM-CC12-D200x20-d40-Z14	●	14	7	200	20	70	40	24			
ASDM-CC12-D250x20-d40-Z16	●	16	8	250	20	90	40	24			

R: Sağ / Right / Правый L: Sol / Left / Левый

● Stokta / In Stock / В наличии ○ Stokta Yok / Non Stock Item / Нет в наличии

Sipariş Örneği/Ordering Example/Образец заказа

1 ad./pcs./шт. ASDM-CC06-D80x8-d27-Z10

Kesme Hesabı : S 367 / Cutting Calculation : P 367 / Расчет режимов резания: стр. 367

konusulan
the spoken kalite...
quality...



A TİP / A TYPE / A Тип

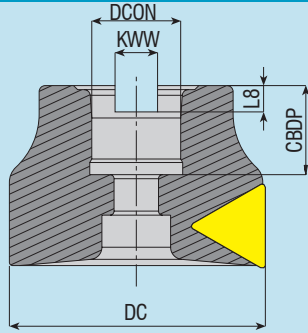

DC	DCON	DBC	KWW	L8	CBDP
40	16	-	8.4	5.6	20
50	22	-	10.4	6.3	22
63	22	-	10.4	6.3	22
80	27	-	12.4	7	25
100	32	-	14.4	8	26

B TİP / B TYPE / B Тип

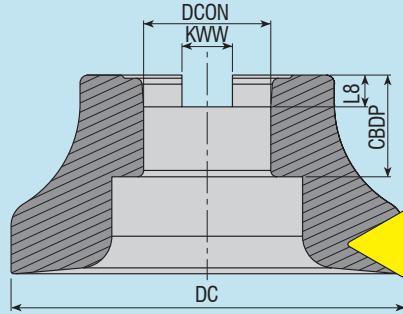

DC	DCON	DBC	KWW	L8	CBDP
125	40	-	16.4	9	32

C TİP / C TYPE / C Тип

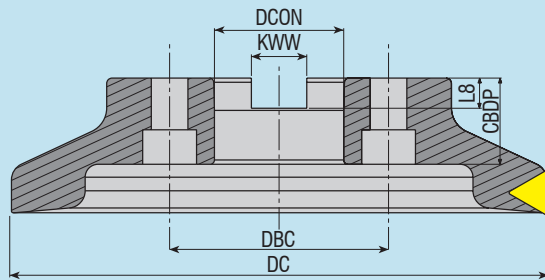

DC	DCON	DBC	KWW	L8	CBDP
160	40	66.7	16.4	9	32
200	60	101.6	25.7	14	40
250	60	101.6	25.7	14	40

D TİP / D TYPE / D Тип

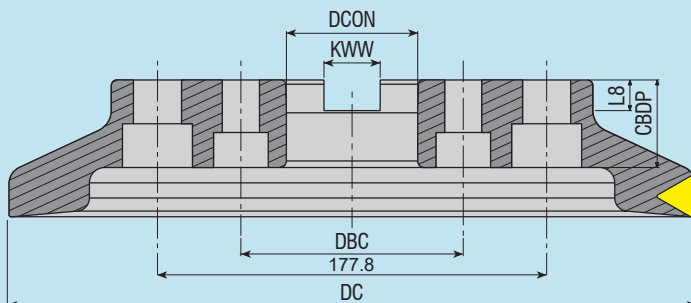

DC	DCON	DBC	KWW	L8	CBDP
315	60	101.6	25.7	14	40

TAKMA UÇLU MATKAP (U-DRILL) KULLANMA KILAVUZU

Matkabınızı CNC torna tezgahına bağlamadan önce taretin merkezden kaçık olup olmadığını kontrol etmeniz gerekir. Şayet taretinizde kaçıklık varsa, takma uçlu matkabınızı kesinlikle kullanmayınız. Taretin düzeltilmesi için yapılması gereken işlemler ;

1. Taretin tutucusuna kullanacağınız takma uçlu matkabın çapında ve boyunda üzeri hassas olan silindirik bir parça bağlanır ve tazgahın X değeri sıfıra getirilir.
2. Tezgahın aynasına mıknatıslı komprotör saati yerleştirilir. Saatin uç kısmı tarete bağlanmış olduğumuz parçanın üstüne temas ettirilir.
3. Aynanın üzerine bağlanmış olduğumuz mıknatıslı komprotör ayna ile beraber 360 derece döndürülerek saatteki değişim oranına göre taretin sıfırlanması sağlanır.

TAKMA UÇLU MATKABINIZI CNC TORNANIZDA DAHA VERİMLİ KULLANMANIZ İÇİN GEREKLİ OLAN KESME HIZLARI ve DEVİRLERİ :

Grup No.	Malzemenin Cinsi	Malzemenin Öz.	Kesme Hızı Vc (m/dk)
1	Çok Yumuşak İş Çelikleri	C1010, Otomat vb.	220
2	İmalat Çelik ve Döküm Malz.	C1030 - 106 vb.	200
3	Takım ve İmalat Çeşitleri	CK-45, 4140, 7131 vb.	170
4	Sıcak İş ve Paslanmaz Çelikler	İmpaks vb.	150

Devir hesabı yapabilmek için önce malzemeyi seçiniz. Seçtiğiniz malzemenin kesme hızını (Vc) 1000 ile çarpıp 3.14'e bölmeliyiz. Çıkan değeri matkap çapına bölmeliyiz. **ÖRNEK** : Malzememiz takım ve imalat çeliği (3. grup), matkap çapı 25 mm kesme hızı 170 ise $170 \times 1000 = 170000 / 3.14 = 54140$, $54140 / 25 = 2166$ devir çıkar (Tezgahın İş Mili Devri). Tezgahın ilerlemesi kullanacağınız uç ile de alakalı olup 0.05 ile 0.10 arasında değişim gösterir. Kullanıcı kesici ucun kesişine göre bunu ayarlar.

İŞLEME MERKEZLERİ İÇİN İLERLEME HESABI :

Yukarıdaki hesaplamalarla bulmuş olduğunuz 2166 iş mili devrini, kesici uç ilerlemesi (mm/devir) 0.05 ile 0.10 arasındaki ilerleme seçenekleri ile çarpılır. **ÖRNEK 1** : $2166 \times 0.05 = 108$ **ÖRNEK 2** : $2166 \times 0.10 = 217$ çıkan sonuçlar 108 ve 217 işleme merkezleri için ilerleme mm/dakika hesabıdır.

Not: D4 ve üzeri takma uçlu matkaplarda tezgahın içten su verme basıncının en az 6 bar olması gerekmektedir.

USER'S GUIDE FOR AKKO U-DRILLS

Before connecting your U-Drill to CNC lathe, you have to check if the turret is eccentric from the center or not. If there is any eccentricity in your turret, never use your U-Drill;

Processes that should be done to fix the turret :

1. A cylindrical part whose surface is precision and whose length and diameter is the same with the U-Drill that you will use, should be mounted to the holder of turret and X value of the lathe should be brought to zero (0).
2. Comparator should be mounted to chuck. The end of the comparator should be contacted (touched) to the surface of the part that we mounted on the turret.
3. The comparator that we mounted on the chuck should be turned 360-degree with the chuck and turret should be zeroed by that turning according to changing rate of comparator.

CUTTING SPEED AND REVOLUTION THAT ARE NEEDED FOR USING (RUNNING) YOUR U-DRILLS MORE PRODUCTIVELY

Grup No.	Material	Material Type	Cutting Speed Vc (m/m)
1	Non-alloy steel and free cutting steel	C1010. Automat etc.	220
2	Low alloy steel and cast steel	C1030 - 106 etc.	200
3	Alloy steel and tool steel	CK-45, 4140, 7131 etc.	170
4	Hot Work Steel and Stainless Steel	Impax etc.	150

P.S. : The cutting speed may be concerned with the type of the insert that you use.

Fistly, choose the material to make calculation of revolution. You should multiply the cutting speed (Vc) of the material that you chose by 1000 and divide by 3.14. You should divide the value that you found by the diameter of U-Drill. For Example : If our material is alloy steel and tool steel (3rd group), diameter of the U-Drill is 25 mm, cutting speed is 170, we should calculate as following; $170 \times 1000 = 170000 / 3.14 = 54140$, $54140 / 25 = 2166$ rpm is the result that we found (Spindle Speed) Feed rate of the lathe is concerned with the U-Drill that you will use and changes between 0.05 and 0.10. The user sets it according to cut of cutting insert.

FEED CALCULATION FOR CENTRAL MACHINE :

2166 spindle speed, that we found as a result of above mentioned calculation, should be multiplied by cutting insert feed (mm/r) between 0.05 and 0.10 feed choisses. Example 1 : $2166 \times 0.05 = 108$

Example 2 : $2166 \times 0.10 = 217$ The results 108 and 217 are the feed mm/m calculation for central machine.

Note: Cooling water pressure of lathe must be minimum 6 bar for our D4 u-drills and u-dirlls longer than D4.

РУКОВОДСТВО ПО ЭКСПЛУАТАЦИИ СВЕРЕЛ

Перед началом работы на токарном станке не обходимо убедиться в расположении оси центров револьверной головки.

1. Установить позицию револьверной головки, в которую предполагается закрепить сверло и вывести по оси X в нулевое положение.
2. Обкатать индикатором часового типа посадочное отверстие резцедержателя или контрольной оправки зажатой в резцедержатель.
3. Проверните шпиндель на полный оборот. При необходимости отрегулируйте положение револьверной головки.

РЕЖИМЫ РЕЗАНИЕ

№	Материал	Марка	Скорость резания Vc (м/мин)
1	Нелегированная сталь и быстрорежущая сталь	C1010. Automat и т.д.	220
2	Низколегированная сталь и литая сталь	C1030 - 106 vb.	200
3	Инструментальная и легированная стал	CK-45, 4140, 7131 vb.	170
4	Закаленная и нержавеющая сталь	Imрах и т.д.	150

П.С.: скорость резания зависит от материала режущей пластины. Сначала выбирают скорость резания и рассчитывают обороты шпинделя по формуле $S=(1000 \times Vc)/(\pi \times \varnothing D)$, об/мин.

Например: если планируется сверление $\varnothing 25$ в легированной стали, то следует выбрать стартовую скорость резания 170 м/мин. Следовательно $S=(1000 \times 170)/(3.14 \times 25)=2166$ об/мин.

Подачу следует выбрать согласно рекомендаций производителя пластин обычно для сверла диаметром она варьируется в диапазоне $S=0,05...0,10$ мм/об.

РАСЧЕТ ПОДАЧИ:

Вторым этапом для ранее рассчитанной частоте вращения шпинделя назначается подача на оборот и рассчитывается минутная подача $F=S \times fz$, мм/мин. Пример, $F_{min}=2166 \text{ об/мин} \times 0,05 \text{ мм/об}=108,3 \text{ мм/мин}$; $F_{max}=2166 \text{ об/мин} \times 0,10 \text{ мм/об}=216,6 \text{ мм/мин}$ Примечание: при глубине сверления свыше $4D$ давление СОЖ должно превышать 6 бар.

SIKMA TORKU TAVSİYELERİ - RECOMMENDED TIGHTENING TORQUE

Рекомендуемый момент затяжки

- Takımı Sıkmadan Önce Aşağıdaki Bilgileri Okuyunuz.
Read below information before tightening the tool.
Прочтите нижеследующую информацию, прежде чем затягивать инструмент
- Vidalı Takımın Vida Ölçüsü ile Tutucunun İç Vida Ölçüsünü Sıkmadan Önce Kontrol Ediniz.
Check screw set's the screw size and together with mounting arbor inner dimension of screws.
Проверьте совпадают ли размеры резьбы фрезерной головки и оправки
- Takımı Tutucuya Sıkarken Tablodaki İlgili Değerlere Göre İşlem Yapınız.
When tightening head to an arbor, follow the related tightening torque in the table.
При затягивании фрезерной головки в оправке, следуйте значениям крутящего момента в таблице ниже

Vida Screw Резьба	Tork Torque (N.m) Крутящий момент (Н·м)
M6	8
M8	23
M10	46
M12	80
M16	90

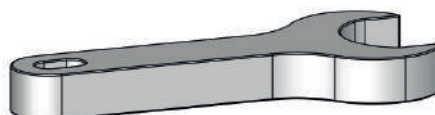

FREZELEME İŞLEMİNDE DEVİR ve İLERLEME HESABI

Vc.	S	D	F	Z	fz	FORMÜLLER
Kesme Hızı (Uç Kutusunun Arkasından Okuyunuz)	İş Mili Devir Sayısı	Tarama Kafası Çapı	İlerleme	Tarama Kafası Ağız Sayısı	Diş Başına Düşen İlerleme Miktarı (Uç Kutusunun Arkasından Okuyunuz)	Devir Hesabı : $S=(Vc \times 1000) / (3,14 \times D)$ İlerleme Hesabı : $F=S \times Z \times fz$

Örnek : D=50 mm çapında, Z=5 ağızlı tarama kafası ile frezeleme yapacağız. Kesici uç kutusunun arkasında kesme hızı Vc=200m/dk. olarak verilmiş olsun. Tezgaha girilecek devri hesaplayalım: **Vc=200 m/dk. D=50 mm S =** Öncelikle Kesme Hızı 1000 ile çarpılır, çıkan sonuç 3,14 sayısına bölünür, buradan çıkan sonuç da tarama kafası çapına bölünür.

$S=200 \times 1000 = 200000 \rightarrow 200000/3,14=63663 \rightarrow 63663/50=1273$ devir **S=1273 dev/dakika** devri bulduktan sonra ilerlemeyi bulalım: **Z=5** ağızlı tarama kafası olsun **fz=0,12** olarak uç kutusunun arkasından okunmuş olsun F= yukarıda bulmuş olduğumuz devir sayısı ile ağız sayısı çarpılır, çıkan sonuç diş başına düşen ilerleme miktarı ile çarpılır.

$F=1273 \times 5 = 6365 \rightarrow 6365 \times 0,12 = 763$ $F=763$ mm/dakika

Tezgaha girilecek olan devir = S 1273 Tezgaha girilecek olan ilerleme : **F 763 ortalama değerdir.**

Not: Vc ve fz değerlerinin uç kutusunun arkasında verilmiş olması gerekir. Eğer bu değerler uç kutusunun üzerinde yoksa, kesici ucun katalogundan bulunuz. İşleyeceğiniz malzeme çelik ise P, paslanmaz çelik ise M, dökme demir ise K bölümünde yazılı olan Vc ve fz değerlerini okuyun.

CALCULATING SPINDLE SPEED and FEED RATE FOR MILLING PROCESS

Vc.	S	D	F	Z	fz	FORMULAS
Cutting Speed (Please read from the back- side of cutting insert box)	Spindle Revolution rpm	Milling Tool Diameter	Feed Rate	Number of Effective Tooth	Feed Per Tooth (Please Read From The Back Side of Cutting Insert Box)	Calculation of Revolution : $S=(Vc \times 1000) / (3,14 \times D)$ Feed Rate Calculation : $F=S \times Z \times fz$

For Example : We will make milling with milling tool whose diameter is D 50 mm, whose teeth number is Z=5. The spindle revolution was written as Vc=200m/mn at the back side of cutting insert box. Let's calculate the revolution that should be entered to the milling machine : Vc=200 m/mn D=50 mm
S = Firstly Cutting Speed is multiplied with 1000, the result should be divided by 3.14 , the last result should be divided by diameter of milling tool.

$S = 200 \times 1000 = 200000 \rightarrow 200000/3,14 = 63663 \rightarrow 63663/50 = 1273$ rev $S=1273$ rev / mn

After finding spindle revolution, let's find feed rate : milling tool with Z=5 teeth and we read fz=0,12 from the back side of cutting insert box.

F = Tooth number should be multiplied with revolution, the result should be multiplied with feed per tooth.

$F = 1273 \times 5 = 6365 \rightarrow 6365 \times 0,12 = 763$ $F = 763$ mm / mn

Revolution that should be entered to the milling machine = S 1273 Feed Rate that should be entered to the milling machine = F 763 average value.

P.S : The values Vc and fz has to be written at the back side of the cutting insert. If these values were not written on the cutting insert box, please find them from cutting insert catalogue. If the material that you will work is steel, please read Vc and fz values that were written on the part P, if it is stainless steel please read from the part M, if it is cast iron please read from the part K.

РАСЧЕТ СКОРОСТИ ВРАЩЕНИЯ ШПИНДЕЛЯ И ПОДАЧИ ДЛЯ ФРЕЗЕРОВАНИЯ

Vc.	S	D	F	Z	fz	Formeln
Скорость резания (Пожалуйста прочитайте на обратной стороне упаковки пластины)	Частота вращения шпинделя (мм/об*мин)	Диаметр фрезы	Скорость подачи	Число эффективных зубьев	Подача на зуб (Пожалуйста прочитайте на обратной стороне упаковки пластины)	Расчет частоты вращения шпинделя: $S=(Vc \times 1000) / (3,14 \times D)$ Расчет скорости подачи: $F=S \times Z \times fz$

Например, для фрезы $\varnothing 50$ с числом зубьев 5. Для выбранной СМП рекомендуемые Vc=200 м/мин; fz=0,12м/мин. Обороты шпинделя $S=(1000 \times Vc)/(\pi \times \varnothing D)=(1000 \times 200)/(3,1416 \times 50)=1273$ об/мин. Минутная подача $F=S \times fz \times Z=1273 \times 0,12 \times 5=763$ мм/мин.

П.С.: Более точные рекомендации по стартовым скоростям резания Vc и fz можно найти в каталоге производителя СМП. Базовые значения обычно указаны на оборотной стороне коробки СМП. Обрабатываемые материалы зашифрованы буквенно-цветовой маркировкой по ИСО513: P - сталь; M - нерж. стали, K-чугуны, N-цв. сплавы, S-жаропрочные стали, H - закалённые стали.

Gövde Malzemesine Göre Delik İçi Kater Uygulama Kılavuzu

Internal Boring Bars Application Guide, Related to Body Material

Рекомендации по выбору материала хвостовика резца в зависимости от вылета

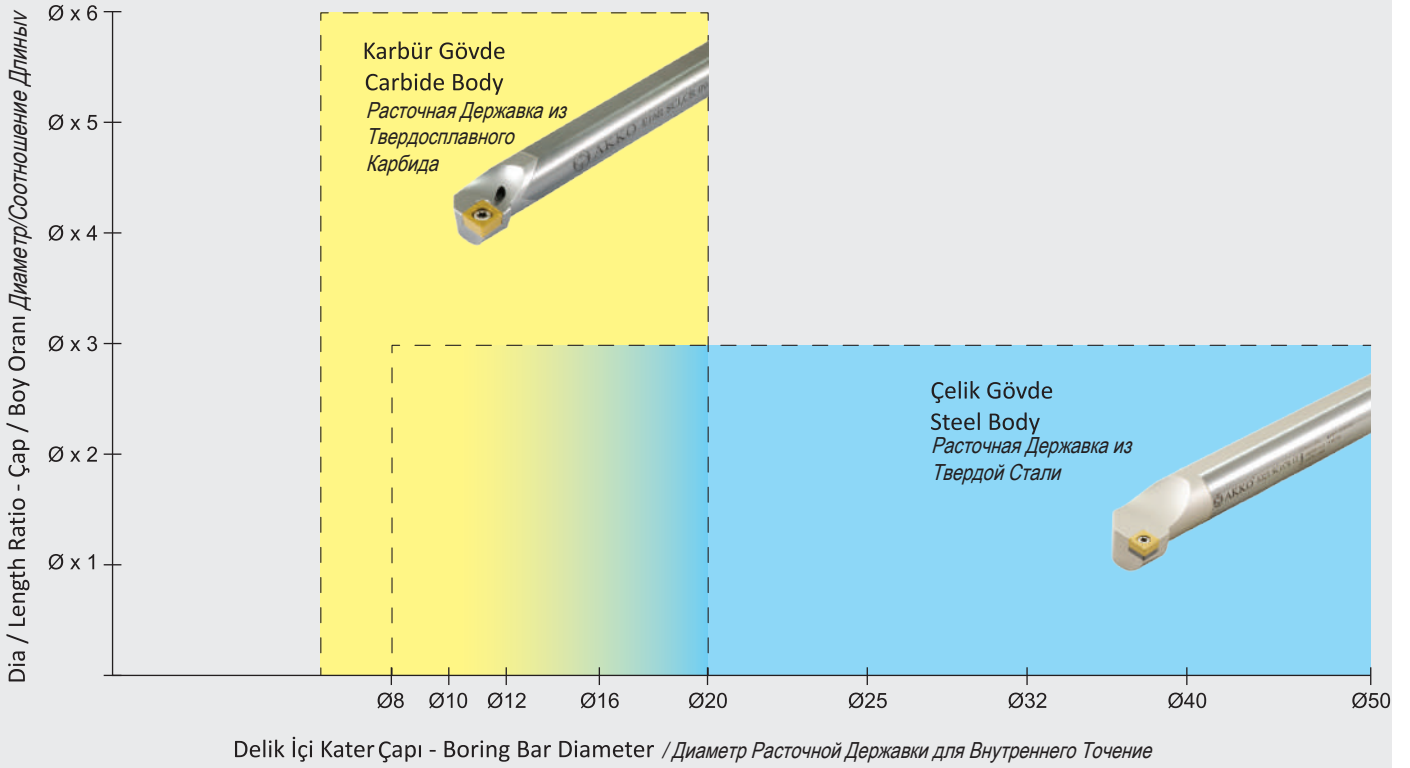

T Kanal Freze Kullanım ve Ön Hazırlama Kılavuzu

Application Guide For T-Slot Milling

Предварительная подготовка заготовки для прорезания T-образных пазов

T kanal frezelemede talaşın rahat boşaltılması için iş parçası resimde gösterildiği şekilde işlenmelidir.

Örnek: ATSM90-CC06- D32X10-W25- L100-Z04 kodlu T freze ile kanal açmadan önce, takımın boğazının çalışacağı kısmın parmak freze ile işlenmesi gerekir. Bu durumda kanalın tamamen işlenmesi çok yanlıştır. Tabanda ($0.8 \times b = 0.8 \times 10$) 8mm işlenmeden bırakılmalıdır. Bu bölgeyi T frezenin işlemesi, takımın daha sağlıklı çalışması açısından gereklidir.

İşlenen kanallarda yumuşak kesim için talaşlar uzaklaştırılmış olmalıdır.

When T slot machining steel, the workpiece must be machined as shown in the drawing to ensure smooth chip evacuation.

Example: Before slotting with the T - slot milling cutter - code ATSM90-CC06-D32X10-W25-L100-Z04,

The area of the neck of the tools to be worked and must be machined by End-Mill.

In this case, it is very wrong to machining the slot completely.

Bottom area ($0.8 \times b = 0.8 \times 10$) should be left 8 mm without machining.

This area's operation must be machined by the T - slot milling cutter which is also necessary for the healthier work of the tool holder. Slots to be machined must be free from chips for smooth machining.

При обработке T-образных пазов необходимо прорезать предварительную канавку согласно эскиза.

Пример: ATSM90-CC06-d32x10-w25-l100-z04 - грибовая фреза $\varnothing 32$ мм и шириной 10 мм.

Первоначально фрезеруют прямоугольный паз шириной равной или меньшей узкой части T-паза и глубиной равной полной глубине, либо с гарантированным перекрытием поднутрения. Максимальный припуск на грибовую фрезу не должен превышать 80% от ширины b. Для вышеуказанной фрезы допустимый припуск 8 мм.

После предварительной прорезки паза необходимо удалить стружку до начала работы грибовой фрезы.

KULLANIM İÇİN UYARI
CAUTION FOR USE
ВАЖНО ДЛЯ ИСПОЛЬЗОВАНИЯ

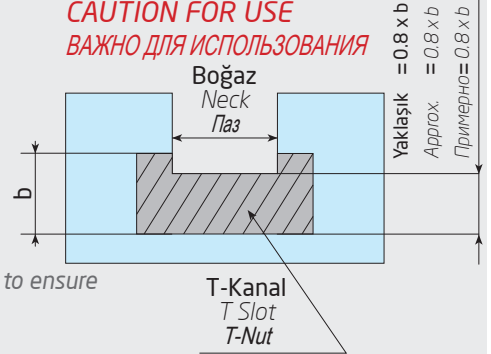

α = 5 Kat Dayanıklılık**α = 5 Times Long Life****α = В 5 раз больше устойчивости****Alfa Kaplamanın Avantajları***Alpha Coating Advantages***Преимущество Альфа покрытия**

- **Yüksek aşınma direnci**
High resistance to abrasion
Высокая стойкость к износу
- **Yüksek yüzey sertliği**
750-800 Vickers
High surface hardness
750-800 Vickers
Высокая твердость поверхности 750-800 Vickers
- **Temperlemeye karşı yüksek direnç**
High resistance to tempering
Высокая устойчивость температуры отпуска
- **Yüksek yorulma mukavemeti**
High fatigue strength
Высокая прочность от усталости
- **Yüksek çizik ve çentik direnci**
High scratch and impact resistance
Высокая устойчивость от царапин и вырезов
- **Paslanmaz olmayan çelikler için daha yüksek korozyon direnci**
Resistant to corrosion of non-stainless steel
Устойчивость от коррозии из нержавеющей стали

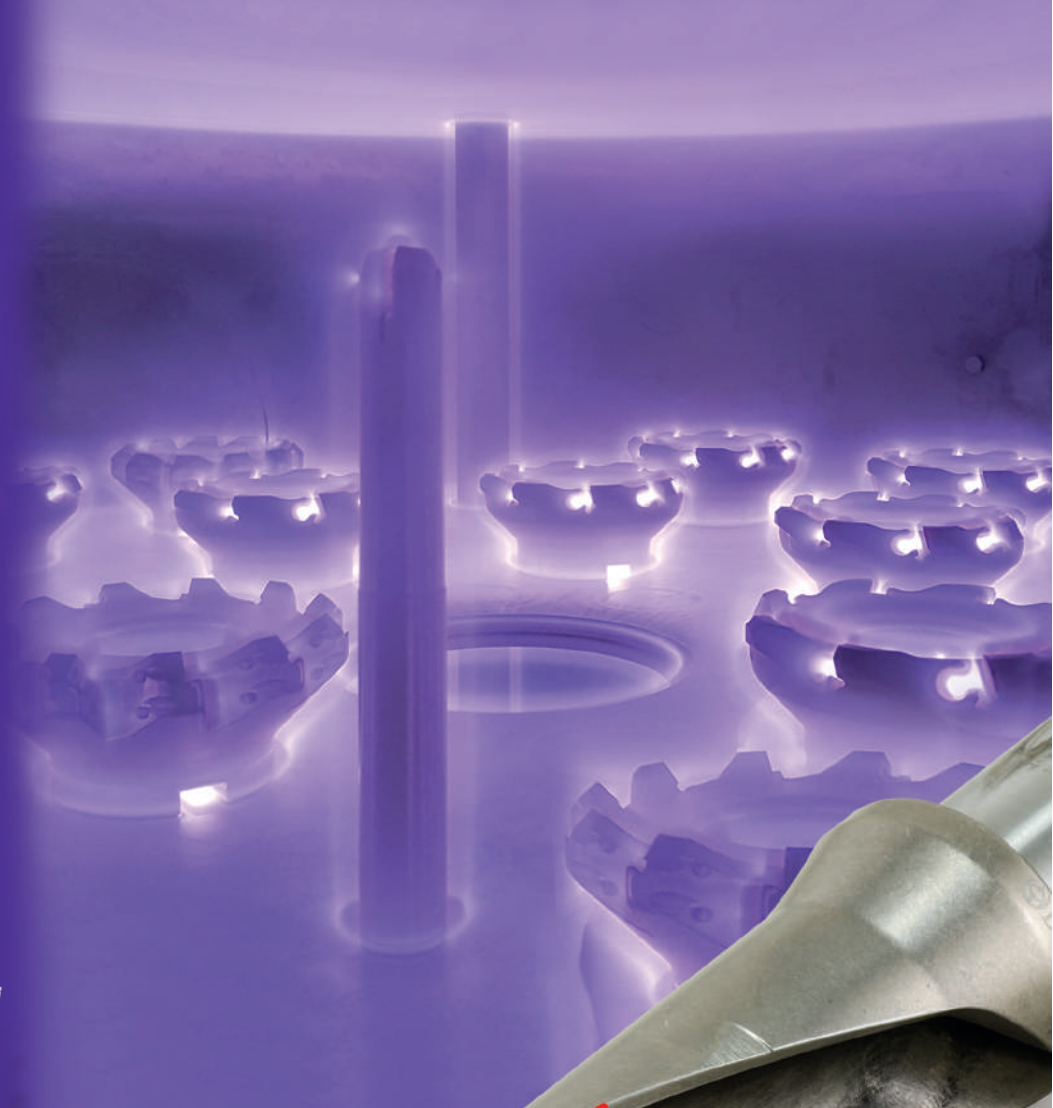

takımınız neden
daha uzun ömürlü
olmasın?...

longer tool life...**Более длительный срок службы инструмента****α Çevre Dostudur. α is friend of environment.**
α Является другом окружающей среды**İnsan sağlığı açısından zararlı değildir. Is not harmful to human health.**
Не вреден для здоровья человека**Gaz ve diğer atıkları çevreyi kirletmez. Gas and other wastes will not pollute the environment.**
Не загрязняет окружающую среду

ALTLIKLAR / SHIMS / ОПОРНЫЕ ПЛАСТИНЫ

ÜRÜN RESMİ/PICTURE ИЗОБРАЖЕНИЕ	ÜRÜN KODU/CODE КОД	ÜRÜN DETAYI / PRODUCT DETAIL ОПИСАНИЕ	
	AATN-2-0001	S-SİSTEM için / For S-SYSTEM / S-ТИП	ТСМТ 16 ALTLIK / SHIM / ОПОРНАЯ ПЛАСТИНА
	AATN-2-0002	T-M SİSTEM için / For T-M SYSTEM / T-M ТИП	TNMG 16 ALTLIK / SHIM / ОПОРНАЯ ПЛАСТИНА
		C-SİSTEM için / For C-SYSTEM / C-ТИП	TNGN 16 ALTLIK / SHIM / ОПОРНАЯ ПЛАСТИНА
	AATN-3-0025	P-SİSTEM için / For P-SYSTEM / P-ТИП	TNMG 16 ALTLIK / SHIM / ОПОРНАЯ ПЛАСТИНА
	AATN-3-0015	T-M-P SİSTEM için / For T-M SYSTEM / T-M-P ТИП	TNMG 22 ALTLIK / SHIM / ОПОРНАЯ ПЛАСТИНА
	AATN-2-0020	DİŞ VİDA 16 ALTLIK / For THREADING 16 SHIM / РЕЗЬБОВАЯ ОПОРНАЯ ПЛАСТИНА 16	
	AATN-2-0004	DİŞ VİDA 22 ALTLIK / For THREADING 22 SHIM / РЕЗЬБОВАЯ ОПОРНАЯ ПЛАСТИНА 22	
	ATS-16E	DİŞ VİDA 16, DİŞ ÇAP SAĞ - DELİK İÇİ SOL ALTLIK / For THREADING SYSTEM 16 SHIM, EXTERNAL RIGHT-INTERNAL LEFT / РЕЗЬБОВАЯ ОПОРНАЯ ПЛАСТИНА 16, НАРУЖНАЯ ПРАВЯЯ - ВНУТРЕННЯЯ ЛЕВАЯ	
	ATS-16I	DİŞ VİDA 16, DİŞ ÇAP SOL - DELİK İÇİ SAĞ ALTLIK / For THREADING SYSTEM 16 SHIM, EXTERNAL LEFT-INTERNAL RIGHT / РЕЗЬБОВАЯ ОПОРНАЯ ПЛАСТИНА 16, НАРУЖНАЯ ЛЕВАЯ - ВНУТРЕННЯЯ ПРАВЯЯ	
	ATS-22E	DİŞ VİDA 22, DİŞ ÇAP SAĞ - DELİK İÇİ SOL ALTLIK / For THREADING SYSTEM 22 SHIM, EXTERNAL RIGHT-INTERNAL LEFT / РЕЗЬБОВАЯ ОПОРНАЯ ПЛАСТИНА 22, НАРУЖНАЯ ПРАВЯЯ - ВНУТРЕННЯЯ ЛЕВАЯ	
	ATS-22I	DİŞ VİDA 22, DİŞ ÇAP SOL - DELİK İÇİ SAĞ ALTLIK / For THREADING SYSTEM 22 SHIM, EXTERNAL LEFT-INTERNAL RIGHT / РЕЗЬБОВАЯ ОПОРНАЯ ПЛАСТИНА 22, НАРУЖНАЯ ЛЕВАЯ - ВНУТРЕННЯЯ ПРАВЯЯ	
	ATS-27E	DİŞ VİDA 27, DİŞ ÇAP SAĞ - DELİK İÇİ SOL ALTLIK / For THREADING SYSTEM 27 SHIM, EXTERNAL RIGHT-INTERNAL LEFT / РЕЗЬБОВАЯ ОПОРНАЯ ПЛАСТИНА 27, НАРУЖНАЯ ПРАВЯЯ - ВНУТРЕННЯЯ ЛЕВАЯ	
	ATS-27I	DİŞ VİDA 27, DİŞ ÇAP SOL - DELİK İÇİ SAĞ ALTLIK / For THREADING SYSTEM 27 SHIM, EXTERNAL LEFT-INTERNAL RIGHT / РЕЗЬБОВАЯ ОПОРНАЯ ПЛАСТИНА 27, НАРУЖНАЯ ЛЕВАЯ - ВНУТРЕННЯЯ ПРАВЯЯ	
	AACN-2-0001	S-SİSTEM için / For S-SYSTEM / S-ТИП	ССМТ 09 ALTLIK / SHIM / ОПОРНАЯ ПЛАСТИНА
		T-SİSTEM için / For T-SYSTEM / T-ТИП	CNMG 09 ALTLIK / SHIM / ОПОРНАЯ ПЛАСТИНА
	AACN-2-0002	P-SİSTEM için / For P-SYSTEM / P-ТИП	CNMG 09 ALTLIK / SHIM / ОПОРНАЯ ПЛАСТИНА
	AACN-2-0003	S-SİSTEM için / For S-SYSTEM / S-ТИП	ССМТ 12 ALTLIK / SHIM / ОПОРНАЯ ПЛАСТИНА
		T-M-P SİSTEM için / For T-M-P SYSTEM / T-M-P ТИП	CNMG 12 ALTLIK / SHIM / ОПОРНАЯ ПЛАСТИНА
		C-SİSTEM için / For C-SYSTEM / C-ТИП	CNGN 12 ALTLIK / SHIM / ОПОРНАЯ ПЛАСТИНА
	AACN-3-0002	T-P SİSTEM için / For T-P SYSTEM / T-P ТИП	CNMG 16 ALTLIK / SHIM / ОПОРНАЯ ПЛАСТИНА
	AACN-3-0003	T-P SİSTEM için / For T-P SYSTEM / T-P ТИП	CNMG 19 ALTLIK / SHIM / ОПОРНАЯ ПЛАСТИНА
	AACN-3-0008	T-P SİSTEM için / For T-P SYSTEM / T-P ТИП	CNMG 25 ALTLIK / SHIM / ОПОРНАЯ ПЛАСТИНА
	AAWN-2-0003	T-M-P SİSTEM için / For T-M-P SYSTEM / T-M-P ТИП	WNMG 08 KALIN ALTLIK / THICK SHIM / ТОЛСТАЯ ОПОРНАЯ ПЛАСТИНА
	AAWN-3-0001	T-M-P SİSTEM için / For T-M-P SYSTEM / T-M-P ТИП	WNMG 08 ALTLIK / SHIM / ОПОРНАЯ ПЛАСТИНА
	AAWN-SW317	T-M-P SİSTEM için / For T-M-P SYSTEM / T-M-P ТИП	WNMG 06 ALTLIK / SHIM / ОПОРНАЯ ПЛАСТИНА
	AKS-16L	C-SİSTEM için / For C-SYSTEM / C-ТИП	KNUX-L 16 ALTLIK / SHIM / ОПОРНАЯ ПЛАСТИНА
	AKS-16R	C-SİSTEM için / For C-SYSTEM / C-ТИП	KNUX-R 16 ALTLIK / SHIM / ОПОРНАЯ ПЛАСТИНА
	AASD-3-0001	S-SİSTEM FREZELEME için / For S-SYSTEM MILLING / S-ТИП ПРИЖИМ ДЛЯ ФРЕЗ ПОД	SDMT 12 ALTLIK / SHIM / ОПОРНАЯ ПЛАСТИНА
	AASE-3-0001	S-SİSTEM FREZELEME için / For S-SYSTEM MILLING / S-ТИП ПРИЖИМ ДЛЯ ФРЕЗ ПОД	SEMT 13 ALTLIK / SHIM / ОПОРНАЯ ПЛАСТИНА
	AASN-2-0001	S-SİSTEM için / For S-SYSTEM / S-ТИП	SCMT 09 ALTLIK / SHIM / ОПОРНАЯ ПЛАСТИНА
	AASN-2-0002	P-SİSTEM için / For P-SYSTEM / P-ТИП	SNMG 09 ALTLIK / SHIM / ОПОРНАЯ ПЛАСТИНА
	AASN-2-0004	S-SİSTEM için / For S-SYSTEM / S-ТИП	SCMT 12 ALTLIK / SHIM / ОПОРНАЯ ПЛАСТИНА
		T-P SİSTEM için / For T-P SYSTEM / T-P ТИП	SNMG 12 ALTLIK / SHIM / ОПОРНАЯ ПЛАСТИНА
	AASN-3-0004	C-SİSTEM için / For C-SYSTEM / C-ТИП	SNGN 12 ALTLIK / SHIM / ОПОРНАЯ ПЛАСТИНА
	AASN-3-0023	T-P SİSTEM için / For T-P SYSTEM / T-P ТИП	SNMG 15 ALTLIK / SHIM / ОПОРНАЯ ПЛАСТИНА
	AASN-3-0005	T-P SİSTEM için / For T-P SYSTEM / T-P ТИП	SNMG 19 ALTLIK / SHIM / ОПОРНАЯ ПЛАСТИНА
	AASN-3-0020	T-P SİSTEM için / For T-P SYSTEM / T-P ТИП	SNMG 25 ALTLIK / SHIM / ОПОРНАЯ ПЛАСТИНА
	AASN-20020	PSDNN KARTUŞ için / For PSDNN CARTRIDGE / ДЛЯ КАРТРИДЖЕЙ	SNMG 12 ALTLIK / SHIM / ОПОРНАЯ ПЛАСТИНА
		AADN-2-0001	S-SİSTEM için / For S-SYSTEM / S-ТИП
		T-SİSTEM için / For T-SYSTEM / T-ТИП	DNMG 11 ALTLIK / SHIM / ОПОРНАЯ ПЛАСТИНА
AADN-SD317		P-SİSTEM için / For P-SYSTEM / P-ТИП	DNMG 11 ALTLIK / SHIM / ОПОРНАЯ ПЛАСТИНА
AADN-3-0001		T-M-P SİSTEM için / For T-M-P SYSTEM / T-M-P ТИП	DNMG 15 ALTLIK / SHIM / ОПОРНАЯ ПЛАСТИНА
		C-SİSTEM için / For C-SYSTEM / C-ТИП	DNGN 15 ALTLIK / SHIM / ОПОРНАЯ ПЛАСТИНА
	AADN-2-0003	T-SİSTEM için / For T-SYSTEM / T-ТИП	DNMG 15 KALIN ALTLIK / THICK SHIM / ТОЛСТАЯ ОПОРНАЯ ПЛАСТИНА
	AAVN-2-0002	S-SİSTEM için / For S-SYSTEM / S-ТИП	VBMT 16, VCMT 16 ALTLIK / SHIM / ОПОРНАЯ ПЛАСТИНА
		T-SİSTEM için / For T-SYSTEM / T-ТИП	VNMG 16 ALTLIK / SHIM / ОПОРНАЯ ПЛАСТИНА
	AAVN-2-0003	S-SİSTEM için / For S-SYSTEM / S-ТИП	VCMT 22 ALTLIK / SHIM / ОПОРНАЯ ПЛАСТИНА
	AARC-3-0001	C-SİSTEM için / For C-SYSTEM / C-ТИП	RCGX 06 ALTLIK / SHIM / ОПОРНАЯ ПЛАСТИНА
	AARC-3-0002	C-SİSTEM için / For C-SYSTEM / C-ТИП	RCGX 09 ALTLIK / SHIM / ОПОРНАЯ ПЛАСТИНА
	AARC-3-0003	C-SİSTEM için / For C-SYSTEM / C-ТИП	RCGX 12 ALTLIK / SHIM / ОПОРНАЯ ПЛАСТИНА
	AARC-3-0005	C-SİSTEM için / For C-SYSTEM / C-ТИП	RCGX 06 ALTLIK / SHIM / ОПОРНАЯ ПЛАСТИНА
	AARC-3-0006	C-SİSTEM için / For C-SYSTEM / C-ТИП	RCGX 09 ALTLIK / SHIM / ОПОРНАЯ ПЛАСТИНА
	AARC-3-0007	C-SİSTEM için / For C-SYSTEM / C-ТИП	RCGX 12 ALTLIK / SHIM / ОПОРНАЯ ПЛАСТИНА

BASKI PABUÇLARI / CLAMPS / ПРИЖИМ

ÜRÜN RESMİ/PICTURE BILD	ÜRÜN KODU/CODE КОД	ÜRÜN DETAYI / PRODUCT DETAIL ОПИСАНИЕ
	ATK-01	T-SİSTEM için / For T-SYSTEM / T-ТИП DNMG 11, WNMG 06, TNMG 16, CNMG 09 BASKI PABUCU / CLAMP / ПРИЖИМ
	ATK-02	T-SİSTEM için / For T-SYSTEM / T-ТИП CNMG 12, WNMG 08, TNMG 22, DNMG 15, SNMG 12 BASKI PABUCU / CLAMP / ПРИЖИМ
	ATK-03	T-SİSTEM için / For T-SYSTEM / T-ТИП VNMG 16 BASKI PABUCU / CLAMP / ПРИЖИМ
	ATK-04	T-SİSTEM için / For T-SYSTEM / T-ТИП CNMG 16, SNMG 15 BASKI PABUCU / CLAMP / ПРИЖИМ
	ATKH-01-R	T-SİSTEM için / For T-SYSTEM / T-ТИП CNMG 12 İÇTEN SOĞUTMA KANALLI BASKI PABUCU / WITH COOLANT TOOLS / С ПОДВОДОМ СОЖ
	ATKH-02-L	T-SİSTEM için / For T-SYSTEM / T-ТИП CNMG 12 İÇTEN SOĞUTMA KANALLI BASKI PABUCU / WITH COOLANT TOOLS / С ПОДВОДОМ СОЖ
	ATKH-03-R	T-SİSTEM için / For T-SYSTEM / T-ТИП TNMG 16 İÇTEN SOĞUTMA KANALLI BASKI PABUCU / WITH COOLANT TOOLS / С ПОДВОДОМ СОЖ
	ATKH-04-L	T-SİSTEM için / For T-SYSTEM / T-ТИП TNMG 16 İÇTEN SOĞUTMA KANALLI BASKI PABUCU / WITH COOLANT TOOLS / С ПОДВОДОМ СОЖ
	ATKH-05-R	T-SİSTEM için / For T-SYSTEM / T-ТИП VNMG 16 İÇTEN SOĞUTMA KANALLI BASKI PABUCU / WITH COOLANT TOOLS / С ПОДВОДОМ СОЖ
	ATKH-06-L	T-SİSTEM için / For T-SYSTEM / T-ТИП VNMG 16 İÇTEN SOĞUTMA KANALLI BASKI PABUCU / WITH COOLANT TOOLS / С ПОДВОДОМ СОЖ
	ATKH-07-R	T-SİSTEM için / For T-SYSTEM / T-ТИП SNMG 15 İÇTEN SOĞUTMA KANALLI BASKI PABUCU / WITH COOLANT TOOLS / С ПОДВОДОМ СОЖ
	ATKH-08-L	T-SİSTEM için / For T-SYSTEM / T-ТИП SNMG 15 İÇTEN SOĞUTMA KANALLI BASKI PABUCU / WITH COOLANT TOOLS / С ПОДВОДОМ СОЖ
	ATKH-09-R	T-SİSTEM için / For T-SYSTEM / T-ТИП CNMG 12 İÇTEN SOĞUTMA KANALLI BASKI PABUCU / WITH COOLANT TOOLS / С ПОДВОДОМ СОЖ
	ATKH-10-L	T-SİSTEM için / For T-SYSTEM / T-ТИП CNMG 12 İÇTEN SOĞUTMA KANALLI BASKI PABUCU / WITH COOLANT TOOLS / С ПОДВОДОМ СОЖ
	AMK-01	M-SİSTEM için / For M-SYSTEM / M-ТИП WNMG 06 BASKI PABUCU / CLAMP / ПРИЖИМ
	AMK-02	M-SİSTEM için / For M-SYSTEM / M-ТИП DELİK İÇİ / INTERNAL Ø20 TNMG 16, Ø25 MT-NR/L 16 BASKI PABUCU / CLAMP M-ТИП ПРИЖИМ ДЛЯ РАСТОЧНЫХ ДЕРЖАВОК Ø20, Ø25 MT-NR/L 16 ПОД TNMG 16
	AMK-03	M-SİSTEM için / For M-SYSTEM / M-ТИП DNMG 11, CNMG 12 BASKI PABUCU / CLAMP / ПРИЖИМ
	AMK-04	M-SİSTEM için / For M-SYSTEM / M-ТИП DNMG 15, TNMG 16-22 BASKI PABUCU / CLAMP / ПРИЖИМ
	AMK-05	M-SİSTEM için / For M-SYSTEM / M-ТИП WNMG 08 BASKI PABUCU / CLAMP / ПРИЖИМ
	AMK-07	M-SİSTEM için / For M-SYSTEM / M-ТИП S20R MCLNR/L BASKI PABUCU / CLAMP / ПРИЖИМ
	AMK-08	M-SİSTEM için / For M-SYSTEM / M-ТИП TNMG 22 BASKI PABUCU / CLAMP / ПРИЖИМ
	ACK-01-R	C-SİSTEM için / For C-SYSTEM / C-ТИП KNUX-R BASKI PABUCU / CLAMP / ПРИЖИМ
	ACK-02-L	C-SİSTEM için / For C-SYSTEM / C-ТИП KNUX-L BASKI PABUCU / CLAMP / ПРИЖИМ
	ACK-03	C-SİSTEM için / For C-SYSTEM / C-ТИП 154.91 DIŞ ÇAP ve DELİK İÇİ/EXTERNAL and INTERNAL/ ДЛЯ НАРУЖНЫХ И ВНУТРЕННИХ ОБРАБОТОК / ПРИЖИМ Ø25-Ø32 / PABUCU / CLAMP
	ACK-04	P-C-SİSTEM için / For P-C-SYSTEM / P-СТИП CTFPR KARTUŞ BASKI PABUCU / CARTRIDGE CLAMP / ПРИЖИМ ДЛЯ КАРТРИДЖЕЙ
	ACK-05	P-C-SİSTEM için / For P-C-SYSTEM / P-СТИП FREZELEME ve DIŞ VIDA AÇMA TAKIMLARINA GÖRE İLAVE BASKI PABUCU ADDITIONAL LITTLE CLAMP for MILLING and THREADING CLAMP P-C-ТИП ДОПОЛНИТЕЛЬНЫЙ ПРИЖИМ ДЛЯ ФРЕЗ И РЕЗЬБОВЫХ ДЕРЖАВОК
	ACK-06	C-SİSTEM için / For C-SYSTEM / C-ТИП 154.91 DELİK İÇİ / INTERNAL / İNNEM Ø16-Ø20 BASKI PABUCU / CLAMP / ПРИЖИМ
	ACK-07	C-SİSTEM için / For C-SYSTEM / C-ТИП SERAMİK CNGN, SNGN, DNGN YEDEK TAKIMI SPARE PART SET of CERAMIC CNGN, SNGN, DNGN C-ТИП ЗАПАСНОЙ КОМПЛЕКТ ПОД КЕРАМИЧЕСКУЮ ПЛАСТИНУ CNGN, SNGN, DNGN
	ACK-08	C-SİSTEM için / For C-SYSTEM / C-ТИП SERAMİK TNGN, YEDEK TAKIMI SPARE PART SET of CERAMIC TNGN C-ТИП ЗАПАСНОЙ КОМПЛЕКТ ПОД КЕРАМИЧЕСКУЮ ПЛАСТИНУ TNGN
	ACK-09	P-SİSTEM için / For P-SYSTEM / P-ТИП CNMG 16-19, SNMG 15-19 İLAVE BÜYÜK BASKI PABUCU ADDITIONAL BIG CLAMP / P-ТИП ДОПОЛНИТЕЛЬНЫЙ БОЛЬШОЙ ПРИЖИМ ПОД CNMG 16-19, SNMG 15-19
	ACK-10	C-SİSTEM FREZELEME için / For C-SYSTEM MILLING C-ТИП ПРИЖИМ ДЛЯ ФРЕЗ ПОД SPKN 12, Ø50-Ø63 TRKN 16 BASKI PABUCU / CLAMP / ПРИЖИМ (M8x8)
	ACK-11	C-SİSTEM FREZELEME için / For C-SYSTEM MILLING C-ТИП ПРИЖИМ ДЛЯ ФРЕЗ ПОД Ø80-Ø100 TRKN 16-TRKN 22, OFKR 07, HNMX 09 BASKI PABUCU / CLAMP / ПРИЖИМ (M8x10)
	ACK-12	C-SİSTEM için / For C-SYSTEM / C-ТИП CTSPR KARTUŞ BASKI PABUCU / CARTRIDGE CLAMP / ПРИЖИМ ДЛЯ КАРТРИДЖЕЙ
	ACK-15	S-SİSTEM FREZELEME için / For S-SYSTEM MILLING S-ТИП ПРИЖИМ ДЛЯ ФРЕЗ ПОД RD.. 10-12 BASKI PABUCU / CLAMP / ПРИЖИМ
	ACK-19	S-SİSTEM FREZELEME için / For S-SYSTEM MILLING S-ТИП ПРИЖИМ ДЛЯ ФРЕЗ ПОД WD0805D BASKI PABUCU / CLAMP / ПРИЖИМ
	ACK-21	C-SİSTEM için / For C-SYSTEM / C-ТИП SN.. 1204.. BASKI PABUCU / CLAMP / ПРИЖИМ
	ACK-23	C-SİSTEM için / For C-SYSTEM / C-ТИП SERAMİK DNGN 11, YEDEK TAKIMI SPARE PART SET of CERAMIC DNGN 11 C-ТИП ЗАПАСНОЙ КОМПЛЕКТ ПОД КЕРАМИЧЕСКИЕ ПЛАСТИНЫ DNGN 11
	ACK-24	S-SİSTEM FREZELEME için / For S-SYSTEM MILLING S-ТИП ПРИЖИМ ДЛЯ ФРЕЗ ПОД XD0806D BASKI PABUCU / CLAMP / ПРИЖИМ
	ACK-26	C-SİSTEM için / For C-SYSTEM / C-ТИП XNNU 0806.. BASKI PABUCU / CLAMP / ПРИЖИМ
	ACK-27	C-SİSTEM için / For C-SYSTEM / C-ТИП RCGX 06 BASKI PABUCU / CLAMP / ПРИЖИМ
	ACK-28	C-SİSTEM için / For C-SYSTEM / C-ТИП RCGX 09 BASKI PABUCU / CLAMP / ПРИЖИМ
	ACK-29	C-SİSTEM için / For C-SYSTEM / C-ТИП RCGX 12 BASKI PABUCU / CLAMP / ПРИЖИМ
	ACK-42	C-SİSTEM için / For C-SYSTEM / C-ТИП RCGX 06 BASKI PABUCU / CLAMP / ПРИЖИМ
	ACK-43	C-SİSTEM için / For C-SYSTEM / C-ТИП RCGX 09 BASKI PABUCU / CLAMP / ПРИЖИМ
	ACK-44	C-SİSTEM için / For C-SYSTEM / C-ТИП RCGX 12 BASKI PABUCU / CLAMP / ПРИЖИМ

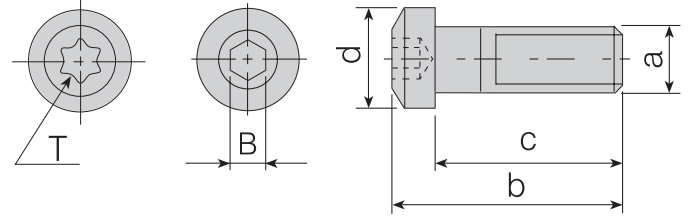

Takım Kodu Ordering Code Код для заказа	BASKI PABUÇ VİDALARI / CLAMP SCREWS / ВИНТЫ ДЛЯ ПРИЖИМОВ					Ürün Detayı / Product Detail / Описание
	a (M)	b	c	d	B(T)	
AKV-01-M5x22	M5x0.8	25.1	22	11	3	T-SİSTEM için / For T-SYSTEM / T-ТИП DNMG 11, WNMG 06, TNMG 16
AKV-02-M6x22	M6x1.0	25.3	22	11	3	T-SİSTEM için / For T-SYSTEM / T-ТИП CNMG 12, WNMG 08, TNMG 22, DNMG 15, SNMG 12, VNMG 16
						M-SİSTEM için / For M-SYSTEM / M-ТИП TNMG 16, TNMG 22
AKV-03-M6x22	M6x1.0	24.5	22	10	3	M-SİSTEM için / For M-SYSTEM / M-ТИП WNMG 08
						KANAL KATERİ için / For EXTERNAL GROOVING 2mm Dış Çap Kanal Kater Vidası / External Grooving Tools Screw ДЛЯ КАНАВЧНЫХ ДЕРЖАВОК 2мм Державка для обработки наружных канавок с подводом СОЖ
AKV-04-M5x17	M6x1.0	20	17	8.5	3	M-SİSTEM için / For M-SYSTEM / M-ТИП S20R MT-NR/L 16, S20R-S25S MWLN/L 06, S25S MDUNR/L 11-Dış Çap / External / AUGEN MWLN/L 06
AKV-05-M6x10	T-SİSTEM için / For T-SYSTEM / T-ТИП Eski Ürün Vidası / Old Products Screws / Винт устаревшей конструкции CNMG 16, SNMG 15
AKV-06-M6x20	M6x1.0	26.5	20	10.6	4	C-SİSTEM için / For C-SYSTEM / C-ТИП KNUX 16
AKV-07-M6x22	M6x1.0	23.5	22	8.5	3	C-SİSTEM için / For C-SYSTEM / C-ТИП ADKT-154.91, AIKT-154.91-R/L-32
AKV-10-M6x14	M6x1.0	16	14	8.8	4	C-SİSTEM için / For C-SYSTEM / C-ТИП AIKT-154.91-R/L-16, AIKT-154.91-R/L-20, AIKT-154.91-R/L-25
AKV-11-M8x29	M8x1.25	33.6	29	11	4	C-SİSTEM için / For C-SYSTEM / C-ТИП TNGN 16, CNGN 12, DNGN 15, SNGN 12
AKV-17-M5x15	M5x0.8	18	15	8.55	3	M-SİSTEM için / For M-SYSTEM / M-ТИП S16P MWLN/L 06
AKV-19-M7x25	M7x1.0	29.6	25	14	4	T-SİSTEM için / For T-SYSTEM / T-ТИП Yeni / New / Новинка CNMG 16, SNMG 15
AKV-20-M6x19	M6x1.0	21.5	19	11	3	M-SİSTEM için / For M-SYSTEM / M-ТИП S25S MDUNR/L 15
AKV-21-M6x18	M6x1.0	20	18	8.5	3	C-SİSTEM için / For C-SYSTEM / C-ТИП AIKT-154.91-R/L-25
AKV-23-M4x10	M4x0.7	12.2	10	7.4	15	KARTUŞ için / For CARTRIDGE / ДЛЯ КАРТРИДЖЕЙ MONTAJ VİDASI / MOUNTING SCREW / МОНТАЖНЫЙ ВИНТ
AKV-27-M6x20	M6x1.0	21.5	20	10	3	M-SİSTEM için / For M-SYSTEM / M-ТИП S25S MWLN/L 08
AKV-30-M6x22	M6x1.0	25	22	11	3	T-SİSTEM için / For T-SYSTEM / T-ТИП Baskı Pabucu / Wedge Clamp / Прижим
AKV-33-M6x22	M6x1.0	25	22	9.5	3	T-SİSTEM için / For T-SYSTEM / T-ТИП T-SİSTEM için / For T-SYSTEM / T-ТИП
AKV-39-M7x21	M7x1.0	25.5	21	11.5	4	T-SİSTEM için / For T-SYSTEM / T-ТИП T-SİSTEM için / For T-SYSTEM / T-ТИП

Ürün Resmi Product Picture Изображение	SOĞUTMA NOZULU / COOLANT NOZZLE / ПРИЖИМ С ПОДВОДОМ СОЖ	
	Ürün Kodu Product Code / Код	Ürün Detayı / Product Detail / Описание
	AN-01	SOĞUTMA NOZULU / Coolant Nozzle / Прижим С Подводом Сож SOĞUTMA NOZULU / Coolant Nozzle / Прижим С Подводом Сож

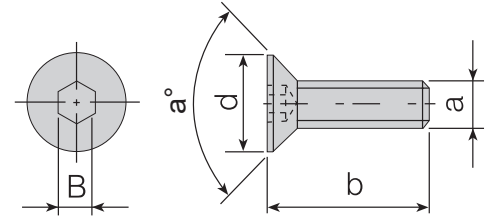

ALTLIK VİDALARI / SHIM SCREWS / ВИНТ ОПОРНОЙ ПЛАСТИНЫ

Takım Kodu Ordering Code Код для заказа	a (M)	b	d	B	a°	Ürün Detayı / Product Detail / Описание
AAV-01-M3x10	M3x0.5	10	5.9	2	90°	T-SİSTEM için / For T-SYSTEM / T-TIIT / WNMG 06, KNUX 16
AAV-02-M5x12	M5x0.8	12	7	3	56°	T-SİSTEM için / For T-SYSTEM / T-TIIT / CNMG 12, WNMG 08, TNMG 22, DNMG 15, SNMG 12
AAV-05-M6x15	M6x1.0	15	9	4	60°	T-SİSTEM için / For T-SYSTEM / T-TIIT / CNMG 16, SNMG 15
AKV-12-M5x12	M5x0.8	12	7.8	3	90°	C-SİSTEM için / For C-SYSTEM / C-TIIT / CTSPR Baskı Pabuç Vidası / Clamp Screw / Зажимной винт
AKV-16-M6x16	M6x1.0	16	10	4	76°	C-SİSTEM için / For C-SYSTEM / C-TIIT / CTFPR 13CS 16 Baskı Pabuç Vidası / Clamp Screw / Зажимной винт
AAV-13-M5x8	M5x0.8	8	7	3	56°	T-SİSTEM için / For T-SYSTEM / T-TIIT / S25S TSKNR/L 12, S25S TCLNR/L 12, S25S TWLNR/L 08, S25S TDUNR/L 15
AAV-14-M5x14	M5x0.8	14	8.8	3	45°	ADCR için / For ADCR / FÜR ADCR / ADCR Montaj Vidası / Mounting Screw / ADCR Монтажный винт

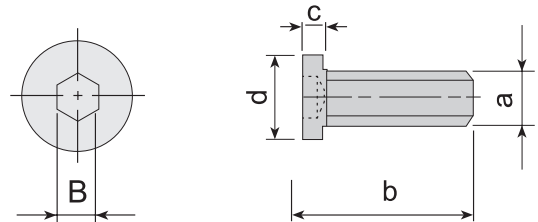

ALTLIK VİDALARI / SHIM SCREWS / ВИНТ ОПОРНОЙ ПЛАСТИНЫ

Takım Kodu Ordering Code Код для заказа	a (M)	b	c	d	B	Ürün Detayı / Product Detail / Описание
AAV-03-M5x12	M5x0.8	12	1.4	6	3	T-SİSTEM için / For T-SYSTEM / T-TIIT / TNMG 16 C-SİSTEM için / For C-SYSTEM / C-TIIT / TNGN 16
AAV-04-M5x12	M5x0.8	12	1.2	6.5	3	T-SİSTEM için / For T-SYSTEM / T-TIIT / VNMG 16, DNMG 11, CNMG 09
AAV-09-M5x9	M5x0.8	9	1.4	6	3	T-SİSTEM için / For T-SYSTEM / T-TIIT / S25S TCLNR/L 09, S25S TDUNR/L 11, S25S TDQNR/L 11

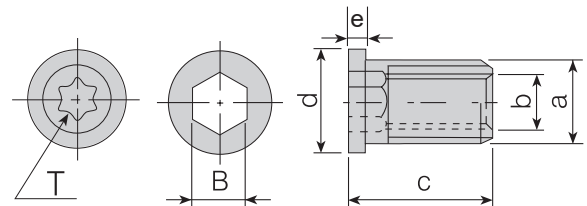

BUKSE VİDALAR / BUKSE SCREWS / ВИНТ ОПОРНОЙ ПЛАСТИНЫ

Takım Kodu Ordering Code Код для заказа	a (M)	b	c	d	B(T)	e	Ürün Detayı / Product Detail / Описание
AAV-06-M3.5x11	M5x0.5	M3.5x0.6	11.3	6	3.5	1.2	S-SİSTEM için / For S-SYSTEM / S-TIIT / CCMT 09, DCMT 11, VBMT 16, VCMT 16, TCMT 16, SCMT 09, 16 ER/L, 16 IR/L
AAV-07-M4.5x13	M6x0.75	M4.5x0.75	13	7.5	4.5	1.6	S-SİSTEM için / For S-SYSTEM / S-TIIT / CCMT 12, SCMT 12, 22 ER/L, 22 IR/L
AAV-08-M3.5x8	M5x0.5	M3.5x0.6	8	6	20	1.2	S-SİSTEM için / For S-SYSTEM / S-TIIT / Ø25 DCMT 11, Ø25-Ø32 CCMT 09, Ø25 TCMT 16, S25S-S32T SVJBR/L 16,
AAV-10-M4.5x8	M6x0.75	M4.5x0.75	8	7.5	4.5	1.05	S-SİSTEM için / For S-SYSTEM / S-TIIT / Ø25-Ø32 CCMT 12, Ø25-Ø32 SCMT 12, SSDCN 1616 H12, SSSCR/L 1616 H12, SIR/L S25R 22
AAV-16-M3.5x8	M5x0.5	M3.5x0.6	8	6	20	1.1	S-SİSTEM için / For S-SYSTEM / S-TIIT / SEMT 13

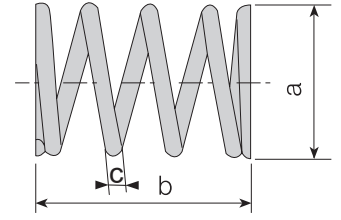
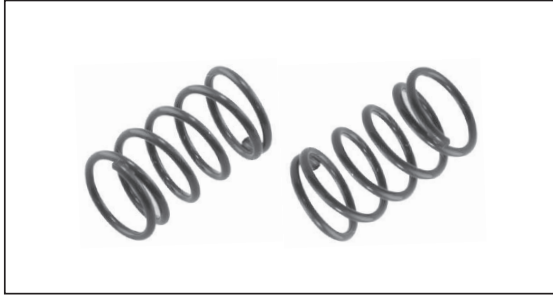

BASKI YAYI / CLAMP SPRING / ПРУЖИНЫ

Takım Kodu Ordering Code Код для заказа	a	b	c	Ürün Detayı / Product Detail / Описание	
				Ürün Detayı / Product Detail / Описание	Ürün Detayı / Product Detail / Описание
AKY-01	7.7	11.2	0.9	T-SİSTEM için / For T-SYSTEM / T-ТИП	CNMG 12, WNMG 08, TNMG 22, DNMG 15, SNMG 12, VNMG 16
AKY-02	8.5	13.5	0.7	C-SİSTEM için / For C-SYSTEM / C-ТИП	KNUX 16

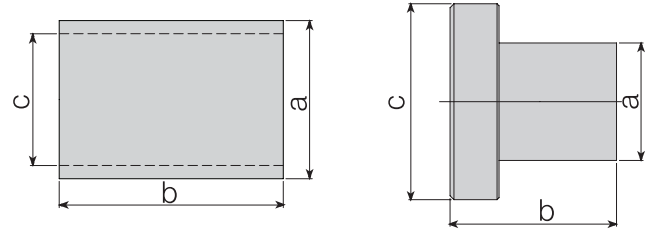
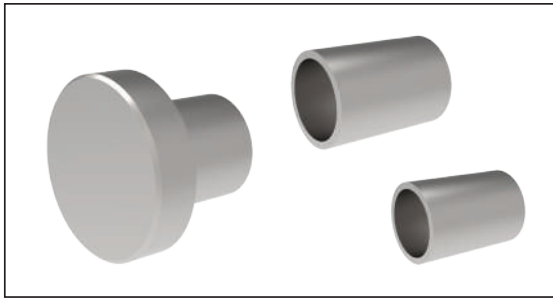

BAĞLANTI PARÇASI / CONNECTION PART / Соединительная часть

Takım Kodu Ordering Code Код для заказа	a	b	c	Ürün Detayı / Product Detail / Описание	
				Ürün Detayı / Product Detail / Описание	Ürün Detayı / Product Detail / Описание
ACP-01	6	8.5	10	TIRLAMAZ TAKIM KARTUŞLARI İÇİN / FOR ANTI VIBRATION TOOLS CARTRIDGES / КАРТРИДЖИ ДЛЯ АНТИВИБРАЦИОННЫХ ДЕРЖАВОК	TIRLAMAZ TAKIM KARTUŞLARI İÇİN / FOR ANTI VIBRATION TOOLS CARTRIDGES / КАРТРИДЖИ ДЛЯ АНТИВИБРАЦИОННЫХ ДЕРЖАВОК
ACP-02	6	8.5	5	TIRLAMAZ TAKIM KARTUŞLARI İÇİN / FOR ANTI VIBRATION TOOLS CARTRIDGES / КАРТРИДЖИ ДЛЯ АНТИВИБРАЦИОННЫХ ДЕРЖАВОК	TIRLAMAZ TAKIM KARTUŞLARI İÇİN / FOR ANTI VIBRATION TOOLS CARTRIDGES / КАРТРИДЖИ ДЛЯ АНТИВИБРАЦИОННЫХ ДЕРЖАВОК
ACP-03	4	5	3	TIRLAMAZ TAKIM KARTUŞLARI İÇİN / FOR ANTI VIBRATION TOOLS CARTRIDGES / КАРТРИДЖИ ДЛЯ АНТИВИБРАЦИОННЫХ ДЕРЖАВОК	TIRLAMAZ TAKIM KARTUŞLARI İÇİN / FOR ANTI VIBRATION TOOLS CARTRIDGES / КАРТРИДЖИ ДЛЯ АНТИВИБРАЦИОННЫХ ДЕРЖАВОК

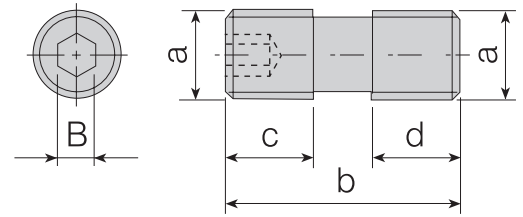

BASKI PABUÇ VİDALARI / CLAMP SCREWS / ВИНТ ДЛЯ ОПОРНОЙ ПЛАСТИНЫ

Takım Kodu Ordering Code Код для заказа	a (M)	b	c	d	B	Ürün Detayı / Product Detail / Описание	
						Ürün Detayı / Product Detail / Описание	Ürün Detayı / Product Detail / Описание
AKV-13-M8x1x16	M8x1.0	16	6.8	6.8	4	C-SİSTEM FREZELEME için / MILLING For C- SYSTEM / C-ТИП	SPKN 12, Ø63 TPKN 16
AKV-14-M8x1x18	M8x1.0	18	8	8	4	C-SİSTEM FREZELEME için / MILLING For C- SYSTEM / C-ТИП	Ø80-Ø100 TPKN 16, Ø63-Ø315 TPKN 22
AKV-15-M8x1x20	M8x1.0	20	8.5	8.5	4	C-SİSTEM FREZELEME için / MILLING For C- SYSTEM / C-ТИП	OFKR 07, HNMX 09
AKV-18-M5x14	M5x0.8	15	5	6.8	2.5	C-SİSTEM FREZELEME için / MILLING For C- SYSTEM / C-ТИП	SN19
AKV-22-M8x1x14	M8x1.0	14	6.8	4.8	4	C-SİSTEM FREZELEME için / MILLING For C- SYSTEM / C-ТИП	Ø50 TPKN 16
AKV-24-M6x1x18	M6x1.0	18	7.5	7.5	3	C-SİSTEM FREZELEME için / MILLING For C- SYSTEM / C-ТИП	SN.. 1204
AKV-26-M6x0.75x20	M6x0.75	20	8.5	8.5	3	C-SİSTEM FREZELEME için / MILLING For C- SYSTEM / C-ТИП	AFM45C-XN0806
AKV-28-M10x1.5x43	M10x1.5	43	18	18	5	WNMU 0907.. Ø50 MONTAJ VIDASI / MOUNTING SCREW / Монтажный винт	WNMU 0907.. Ø50

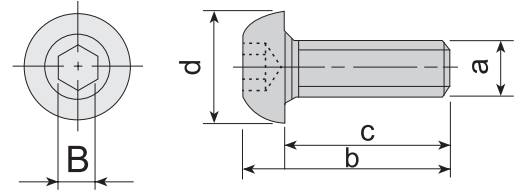

KANAL KATER ve MANTAR VİDALAR / GROOVING TOOL and CLAMP SCREWS / ЗАЖИМНОЙ ВИНТ

Takım Kodu Ordering Code Код для заказа	a (M)	b	c	d	B	Ürün Detayı / Product Detail / Описание
1904-M8x1x20	M8x1.0	25.9	20	11.3	4	S-SİSTEM için / For S-SYSTEM / S-ТИП RCMT 32 Sıkma Vidası / Clamp Screw / Зажимной винт
2004-M8x1x20	M8x1.0	25.9	20	11.4	4	KANAL KATER için / For EXTERNAL GROOVING / FÜR TNMG-IG, TNMG-22 BOHRSTANGE Kanal Kater Vidası / External Grooving Tools Screw / Державка для обработки наружных канавок с подводом СОЖ
2004-M8x20	M8x1.25	30	25	25	4	KANAL KATER için / For EXTERNAL GROOVING / FÜR TNMG-IG, TNMG-22 BOHRSTANGE Eski Kanal Kater Vidası / Old External Grooving Tools Screw Alte / Schraube für Stechhalter
AKV-08-M6x12	M6x1.0	17	12	14.3	4	C-SİSTEM FREZELEME için / MILLING For C-SYSTEM / C-SYSTEM FÜR FRÄSEBASKI ve Sıkma Vidası, Mantar Vida / Clamp Screw / Зажимной винт
AKV-09-M8x18	M8x1.0	24	18	17.2	5	C-SİSTEM FREZELEME için / MILLING For C-SYSTEM / C-SYSTEM FÜR FRÄSEBASKI ve Sıkma Vidası, Mantar Vida / Clamp Screw / Зажимной винт

LEVYELER / LEVERS / РЫЧАГИ

Ürün Resmi Product Picture Изображение	Ürün Kodu Product Code / КОД	Ürün Detayı / Product Detail / Описание
	APL-01	P-SİSTEM için / For P-SYSTEM / P-ТИП CNMG 09, DNMG 11, SNMG 09, TNMG 16, WNMG 06 LEVYESİ / LEVER / РЫЧАГИ
	APL-02	P-SİSTEM için / For P-SYSTEM / P-ТИП CNMG 12, SNMG 12, TNMG 22, WNMG 08 LEVYESİ / LEVER / РЫЧАГИ
	APL-03	P-SİSTEM için / For P-SYSTEM / P-ТИП DNMG 15 LEVYESİ / LEVER / РЫЧАГИ
	APL-04	P-SİSTEM için / For P-SYSTEM / P-ТИП CNMG 16, SNMG 15 LEVYESİ / LEVER / РЫЧАГИ
	APL-05	P-SİSTEM için / For P-SYSTEM / P-ТИП CNMG 19, SNMG 19 LEVYESİ / LEVER / РЫЧАГИ
	APL-06	P-SİSTEM için / For P-SYSTEM / P-ТИП CNMG 25, SNMG 25 LEVYESİ / LEVER / РЫЧАГИ
	APL-07	P-SİSTEM için / For P-SYSTEM / P-ТИП S16P PCLNR/L 09 LEVYESİ / LEVER / РЫЧАГИ
	APL-08	P-SİSTEM için / For P-SYSTEM / P-ТИП S16P PTUNR/L 16 LEVYESİ / LEVER / РЫЧАГИ
	APL-11	P-SİSTEM için / For P-SYSTEM / P-ТИП TNMG 11 LEVYESİ / LEVER / РЫЧАГИ

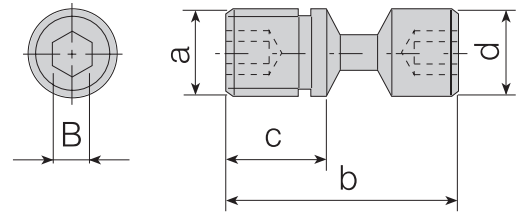

LEVYE VİDALARI / LEVER SCREWS / ФУТОРКА (ВИНТ ОПОРНОЙ ПЛАСТИН)

Takım Kodu Ordering Code Код для заказа	a (M)	b	c	d	B	Ürün Detayı / Product Detail / Описание
ALV-01-M6x14	M6x1.0	14	10	5.85	2.5	P-SİSTEM için / For P-SYSTEM / P-ТИП S20R PCLNR/L 09, S20R PDUNR/L 11, S20R PDQNR/L 11, S20R PWNLR/L 06, S20R PTUNR/L 16
ALV-02-M6x17	M6x1.0	17	10	5.85	2.5	P-SİSTEM için / For P-SYSTEM / P-ТИП CNMG 09, DNMG 11, SNMG 09, TNMG 16, WNMG 06
ALV-03-M8x19	M8x1.0	19.8	11	7.9	3	P-SİSTEM için / For P-SYSTEM / P-ТИП CNMG 12, SNMG 12, TNMG 22, WNMG 08, DNMG 15
ALV-04-M8x22	M8x1.0	21.5	13	7.75	3	P-SİSTEM için / For P-SYSTEM / P-ТИП CNMG 16, SNMG 15
ALV-05-M10x27	M10x1.0	27.5	15	9.9	4	P-SİSTEM için / For P-SYSTEM / P-ТИП CNMG 19, SNMG 19
ALV-06-M12x36	M12x1.0	36	20	12	5	P-SİSTEM için / For P-SYSTEM / P-ТИП CNMG 25, SNMG 25
ALV-07-M6x13	M6x1.0	12.6	6.5	5.9	2.5	P-SİSTEM için / For P-SYSTEM / P-ТИП S16P PCLNR/L 09, S16P PTUNR/L 16
ALV-08-M8x16	M8x1.0	16	10	7.9	3	P-SİSTEM için / For P-SYSTEM / P-ТИП S25S PCLNR/L 12, S25S PDUNR/L 15, S25S PSKNR/L 12
ALV-10-M5x10	M5x0.8	10	4.6	4.9	2.5	P-SİSTEM için / For P-SYSTEM / P-ТИП TNMG 11,

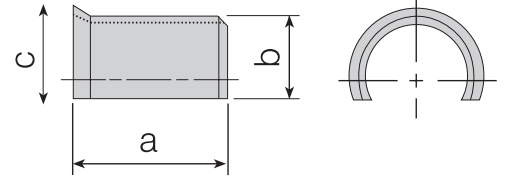
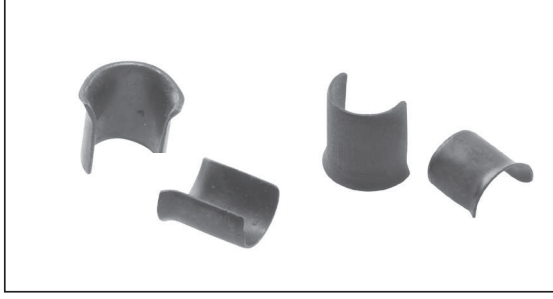

Takım Kodu Ordering Code Код для заказа	ALTLIK YAYLARI / SHIM SPRINGS / ВТУЛКА РЫЧАГА				
	a	b	c	Ürün Detayı / Product Detail / Описание	
AA-Y-01	5.6	4.9	6	P-SİSTEM için / For P-SYSTEM / P-ТИП CNMG 09 ,DNMG 11, SNMG 09, TNMG 16, WNMG 06	
AA-Y-02	6	6.9	7.9	P-SİSTEM için / For P-SYSTEM / P-ТИП CNMG 12, SNMG 12, TNMG 22, WNMG 08, DNMG 15	
AA-Y-03	8.9	8	9.5	P-SİSTEM için / For P-SYSTEM / P-ТИП CNMG 16, SNMG 15	
AA-Y-04	11	9.8	10.7	P-SİSTEM için / For P-SYSTEM / P-ТИП CNMG 19, SNMG 19	
AA-Y-05	12	13	15	P-SİSTEM için / For P-SYSTEM / P-ТИП CNMG 25, SNMG 25	
AA-Y-07	5.6	4.9	6	P-SİSTEM için / For P-SYSTEM / P-ТИП CNMG 09, TNMG 16	

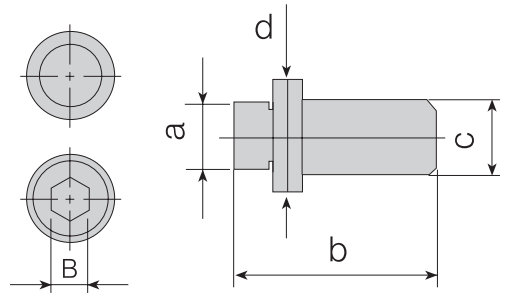
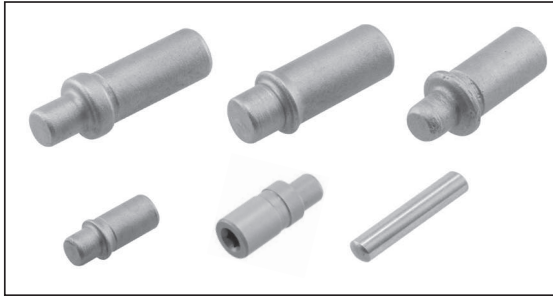

Takım Kodu Ordering Code Код для заказа	PİMLER / PINS / ШТИФТЫ					
	a	b	c	d	B	Ürün Detayı / Product Detail / Описание
APM-01	3.55	18	5	6	-	M-SİSTEM için / For M-SYSTEM / M-ТИП Delik İçi / Internal / Для Внутренних Обработок Ø32-Ø40 TNMG 16 / Dış Çap / External / Для Наружных Обработок TNMG 16
APM-02	5	18	6	7.3	-	M-SİSTEM için / For M-SYSTEM / M-ТИП TNMG 22, WNMG 08
APM-03	3.5	12	5	6.5	-	M-SİSTEM için / For M-SYSTEM / M-ТИП S20R MTFNR/L 16, S20R MT-NR/L 16, S20R MTUNR/L 16, S20R MTQNR/L 16, S20R MDUNR/L 11
APM-04	5	15	6	7.3	-	M-SİSTEM için / For M-SYSTEM / M-ТИП S32T MCLNR/L 12, DNMG 15, S25S MWLNR/L 08
APM-05	4.50	11.5	6.5	6.5	3	M-SİSTEM için / For M-SYSTEM / M-ТИП MSYNR 11.5CS 12 Kartuş için / for Cartridge / Для картриджа
APM-06	3	15.7	-	-	-	C-SİSTEM için / For C-SYSTEM / C-ТИП 154.91
APM-07	3.5	11.5	6.5	6.5	3	M-SİSTEM için / For M-SYSTEM / M-ТИП S20R ET-NR 16
APM-08	3.5	12	5	5.4	-	M-SİSTEM için / For M-SYSTEM / M-ТИП S25S MWLNR/L 06, Dış Çap / External / Для Наружных Обработок
APM-09	3.5	10	5	5.4	-	M-SİSTEM için / For M-SYSTEM / M-ТИП S16P MWLNR/L 06
APM-10	3.5	11	5	5.4	-	M-SİSTEM için / For M-SYSTEM / M-ТИП S20R MWLNR/L 06
APM-11	3.5	11	5	6.5	-	M-SİSTEM için / For M-SYSTEM / M-ТИП S20R MTQNR/L 16
APM-12	5	12	6	7.3	-	M-SİSTEM için / For M-SYSTEM / M-ТИП S20R MCLNR/L 12, S25S MCLNR/L 12-Z
APM-13	5	14	6	7.3	-	M-SİSTEM için / For M-SYSTEM / M-ТИП S25S MCLNR/L 12
APM-14	3.55	15	5	6	-	M-SİSTEM için / For M-SYSTEM / M-ТИП S25S MTFNR/L 16, S25S MT-NR/L 16, S25S MTUNR/L 16, S25S MTQNR/L 16
APM-15	4.40	16	6.40	6.40	3	M-SİSTEM için / For M-SYSTEM / M-ТИП MSYNR 16CS 12 Kartuş için / for Cartridge / Для картриджа

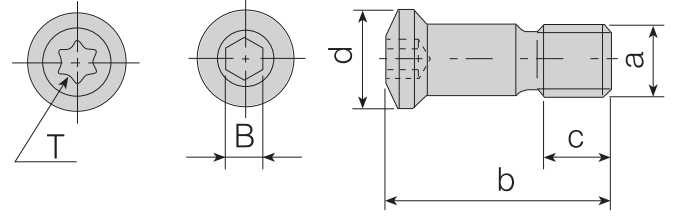
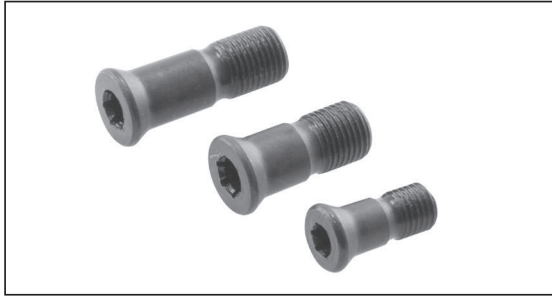

KÜRESEL FİNİŞ VİDALARI / BALL NOSE SCREWS / ВИНТЫ С ПРОТОЧКОЙ

Takım Kodu Ordering Code Код для заказа	a (M)	b	c	d	B(T)	Ürün Detayı / Product Detail / Описание	
1208-M3x7	M3x0.5	6.9	2.7	4.1	8	KÜRESEL FREZE VİDASI / BALL NOSE SCREW / ВИНТ С ПРОТОЧКОЙ	P3208
1215-M4x0.5x9	M4x0.5	8.6	3.2	5.75	15	KÜRESEL FREZE VİDASI / BALL NOSE SCREW / ВИНТ С ПРОТОЧКОЙ	P3210-ROHX 12
1220-M5x0.5x9	M5x0.5	9.6	3.4	6.8	20	KÜRESEL FREZE VİDASI / BALL NOSE SCREW / ВИНТ С ПРОТОЧКОЙ	P3212
1220-M5x0.5x12	M5x0.5	12.9	4.4	7.4	20	KÜRESEL FREZE VİDASI / BALL NOSE SCREW / ВИНТ С ПРОТОЧКОЙ	P3216-ROHX 16
1220-M5x0.5x15	M5x0.5	16.4	6	7.8	20	KÜRESEL FREZE VİDASI / BALL NOSE SCREW / ВИНТ С ПРОТОЧКОЙ	P3220-ROHX 20
1220-M6x0.75x20	M6x0.75	20	6	9.4	20	KÜRESEL FREZE VİDASI / BALL NOSE SCREW / ВИНТ С ПРОТОЧКОЙ	P3225
1204-M8x0.75x26	M8x0.75	26	7.5	12	4	KÜRESEL FREZE VİDASI / BALL NOSE SCREW / ВИНТ С ПРОТОЧКОЙ	P3232
1210-M3.5x9.6	M3.5x0.6	9.6	4	4.7	10	KÜRESEL FREZE VİDASI / BALL NOSE SCREW / ВИНТ С ПРОТОЧКОЙ	BNM 12
1215-M4x13.5	M4x0.7	13.5	5	5.8	15	KÜRESEL FREZE VİDASI / BALL NOSE SCREW / ВИНТ С ПРОТОЧКОЙ	BNM 16

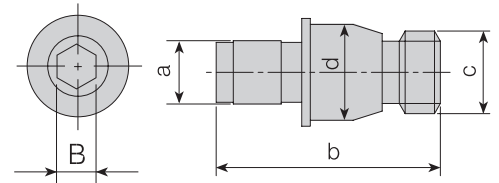
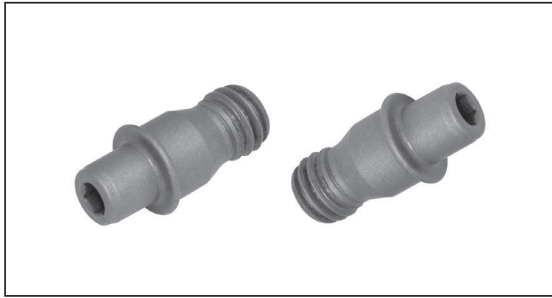

EKSANTRİK VİDA / ECCENTRIC SCREW / ВИНТ С ЭКСЦЕНТРИКОМ

Takım Kodu Ordering Code Код для заказа	a	b	c	d	B	Ürün Detayı / Product Detail / Описание	
AEV-01-M6x16	4.85	16	M6x1.0	6.5	2.5	Eksantrik Vida / Eccentric Screw / Эксцентричный винт	PSDNN Kartuş için / for Cartridge / Для картриджа

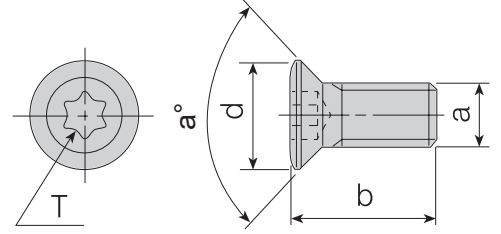

TORK VİDALARI / TORX SCREWS / ВИНТЫ TORX

Takım Kodu Ordering Code Код для заказа	a (M)	b	T	d	a°	Ürün Detayı / Product Detail / Описание	
4006-M1.6x3.2	M1.6x0.35	3.2	6	2.5	60	S-SİSTEM için / For S-SYSTEM / S-ТИП	TORK VİDA / TORX SCREW / ВИНТЫ TORX
3006-M1.8x4	M1.8x0.35	4	6	2.45	60	S-SİSTEM için / For S-SYSTEM / S-ТИП	TORK VİDA / TORX SCREW / ВИНТЫ TORX
3006-M2x3.1	M2x0.4	3.1	6	2.7	60	S-SİSTEM için / For S-SYSTEM / S-ТИП	TORK VİDA / TORX SCREW / ВИНТЫ TORX
3006-M2x3.3	M2x0.4	3.3	6	2.7	60	S-SİSTEM için / For S-SYSTEM / S-ТИП	TORK VİDA / TORX SCREW / ВИНТЫ TORX
3006-M2x3.6	M2x0.4	3.6	6	2.7	60	S-SİSTEM için / For S-SYSTEM / S-ТИП	TORK VİDA / TORX SCREW / ВИНТЫ TORX
3006-M2x4	M2x0.4	4.3	6	2.7	60	S-SİSTEM için / For S-SYSTEM / S-ТИП	TORK VİDA / TORX SCREW / ВИНТЫ TORX
4006-M2x5	M2x0.4	5	6	3	55	S-SİSTEM için / For S-SYSTEM / S-ТИП	TORK VİDA / TORX SCREW / ВИНТЫ TORX
3007-M2.2x4.6	M2.2x0.45	4.6	7	3.15	60	S-SİSTEM için / For S-SYSTEM / S-ТИП	TORK VİDA / TORX SCREW / ВИНТЫ TORX
4006-M2.2x5	M2.2x0.45	5	6	2.8	55	S-SİSTEM için / For S-SYSTEM / S-ТИП	TORK VİDA / TORX SCREW / ВИНТЫ TORX
1008-M2.5x5	M2.5x0.45	5.5	8	3.5	45	S-SİSTEM için / For S-SYSTEM / S-ТИП	TORK VİDA / TORX SCREW / ВИНТЫ TORX
1008-M2.5x7	M2.5x0.45	7	8	3.6	45	S-SİSTEM için / For S-SYSTEM / S-ТИП	TORK VİDA / TORX SCREW / ВИНТЫ TORX
1108-M2.5x6	M2.5x0.45	6	8	3.9	R	S-SİSTEM için / For S-SYSTEM / S-ТИП	TORK VİDA / TORX SCREW / ВИНТЫ TORX
3008-M2.5x5	M2.5x0.45	5	8	3.5	60	S-SİSTEM için / For S-SYSTEM / S-ТИП	TORK VİDA / TORX SCREW / ВИНТЫ TORX
3008-M2.5x6	M2.5x0.45	6	8	3.5	60	S-SİSTEM için / For S-SYSTEM / S-ТИП	TORK VİDA / TORX SCREW / ВИНТЫ TORX
3008-M2.5x8	M2.5x0.45	8	8	3.5	50	S-SİSTEM için / For S-SYSTEM / S-ТИП	TORK VİDA / TORX SCREW / ВИНТЫ TORX
4008-M2.5x4	M2.5x0.45	4	8	3.5	45	S-SİSTEM için / For S-SYSTEM / S-ТИП	TORK VİDA / TORX SCREW / ВИНТЫ TORX
4008-M2.5x4.5	M2.5x0.45	4.5	8	3.5	45	S-SİSTEM için / For S-SYSTEM / S-ТИП	TORK VİDA / TORX SCREW / ВИНТЫ TORX
4008-M2.5x6	M2.5x0.45	5.8	8	3.5	45	S-SİSTEM için / For S-SYSTEM / S-ТИП	TORK VİDA / TORX SCREW / ВИНТЫ TORX
4008-M2.5x6.5	M2.5x0.45	6.5	8	4	60	S-SİSTEM için / For S-SYSTEM / S-ТИП	TORK VİDA / TORX SCREW / ВИНТЫ TORX
4108-M2.5x6.5	M2.5x0.45	6.5	8	3.5	50	S-SİSTEM için / For S-SYSTEM / S-ТИП	TORK VİDA / TORX SCREW / ВИНТЫ TORX
4108-M2.5x8	M2.5x0.45	8	8	3.5	50	S-SİSTEM için / For S-SYSTEM / S-ТИП	TORK VİDA / TORX SCREW / ВИНТЫ TORX
1008-M3x6	M3x0.5	6	8	4	60	S-SİSTEM için / For S-SYSTEM / S-ТИП	TORK VİDA / TORX SCREW / ВИНТЫ TORX
1008-M3x8	M3x0.5	8	8	3.9	60	S-SİSTEM için / For S-SYSTEM / S-ТИП	TORK VİDA / TORX SCREW / ВИНТЫ TORX
1108-M3x6.8	M3x0.5	6.8	8	4	60	S-SİSTEM için / For S-SYSTEM / S-ТИП	TORK VİDA / TORX SCREW / ВИНТЫ TORX
3008-M3x6	M3x0.5	6	8	4	45	S-SİSTEM için / For S-SYSTEM / S-ТИП	TORK VİDA / TORX SCREW / ВИНТЫ TORX
3008-M3x7	M3x0.5	7	8	4	55	S-SİSTEM için / For S-SYSTEM / S-ТИП	TORK VİDA / TORX SCREW / ВИНТЫ TORX
3008-M3x8	M3x0.5	8	8	4	45	S-SİSTEM için / For S-SYSTEM / S-ТИП	TORK VİDA / TORX SCREW / ВИНТЫ TORX
3108-M3x6	M3x0.5	6	8	3.8	60	S-SİSTEM için / For S-SYSTEM / S-ТИП	TORK VİDA / TORX SCREW / ВИНТЫ TORX
4008-M3x8	M3x0.5	8	8	4	60	S-SİSTEM için / For S-SYSTEM / S-ТИП	TORK VİDA / TORX SCREW / ВИНТЫ TORX
4010-M3x6	M3x0.5	6	10	4.2	45	S-SİSTEM için / For S-SYSTEM / S-ТИП	TORK VİDA / TORX SCREW / ВИНТЫ TORX
4010-M3x8	M3x0.5	8	10	4.2	45	S-SİSTEM için / For S-SYSTEM / S-ТИП	TORK VİDA / TORX SCREW / ВИНТЫ TORX
1015-M3.5x9	M3.5x0.6	9	15	5.3	60	S-SİSTEM için / For S-SYSTEM / S-ТИП	TORK VİDA / TORX SCREW / ВИНТЫ TORX
1015-M3.5x11	M3.5x0.6	11.1	15	5.3	60	S-SİSTEM için / For S-SYSTEM / S-ТИП	TORK VİDA / TORX SCREW / ВИНТЫ TORX
1015-M3.5x14	M3.5x0.6	14	15	5.3	66	S-SİSTEM için / For S-SYSTEM / S-ТИП	TORK VİDA / TORX SCREW / ВИНТЫ TORX
1015-M3.5x16	M3.5x0.6	16	15	5.3	55	S-SİSTEM için / For S-SYSTEM / S-ТИП	TORK VİDA / TORX SCREW / ВИНТЫ TORX
1315-M3.5x11	M3.5x0.6	10.6	15	7.9	-	S-SİSTEM için / For S-SYSTEM / S-ТИП	TORK VİDA / TORX SCREW / ВИНТЫ TORX
1510-M3.5x7	M3.5x0.6	7.1	10	5.1	55	S-SİSTEM için / For S-SYSTEM / S-ТИП	TORK VİDA / TORX SCREW / ВИНТЫ TORX
1510-M3.5x9	M3.5x0.6	9.1	10	5	55	S-SİSTEM için / For S-SYSTEM / S-ТИП	TORK VİDA / TORX SCREW / ВИНТЫ TORX
1615-M3.5x10	M3.5x0.6	10	15	5.8	60	S-SİSTEM için / For S-SYSTEM / S-ТИП	TORK VİDA / TORX SCREW / ВИНТЫ TORX
1615-M3.5x11	M3.5x0.6	11	15	5.8	60	S-SİSTEM için / For S-SYSTEM / S-ТИП	TORK VİDA / TORX SCREW / ВИНТЫ TORX
1615-M3.5x15	M3.5x0.6	15	15	5.8	60	S-SİSTEM için / For S-SYSTEM / S-ТИП	TORK VİDA / TORX SCREW / ВИНТЫ TORX
3010-M3.5x7	M3.5x0.6	7	10	5	55	S-SİSTEM için / For S-SYSTEM / S-ТИП	TORK VİDA / TORX SCREW / ВИНТЫ TORX
3010-M3.5x9	M3.5x0.6	9	10	5	55	S-SİSTEM için / For S-SYSTEM / S-ТИП	TORK VİDA / TORX SCREW / ВИНТЫ TORX
3015-M3.5x9	M3.5x0.6	8.8	15	5.4	60	S-SİSTEM için / For S-SYSTEM / S-ТИП	TORK VİDA / TORX SCREW / ВИНТЫ TORX
4015-M3.5x8	M3.5x0.6	7.9	15	5.3	55	S-SİSTEM için / For S-SYSTEM / S-ТИП	TORK VİDA / TORX SCREW / ВИНТЫ TORX
4015-M3.5x9	M3.5x0.6	8.7	15	5.3	60	S-SİSTEM için / For S-SYSTEM / S-ТИП	TORK VİDA / TORX SCREW / ВИНТЫ TORX
4015-M3.5x10	M3.5x0.6	9.8	15	5.3	60	S-SİSTEM için / For S-SYSTEM / S-ТИП	TORK VİDA / TORX SCREW / ВИНТЫ TORX

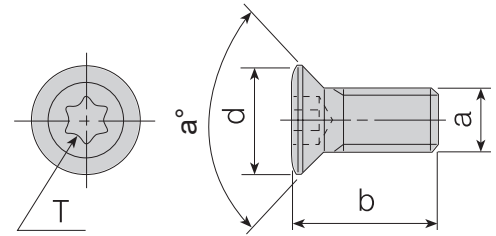

TORK VİDALARI / TORX SCREWS / ВИНТЫ TORX

Таким Kodu Ordering Code Код для заказа	a (M)	b	T	d	a°	Ürün Detayı / Product Detail / Описание	
4015-M3.5x11	M3.5x0.6	10.7	15	5.3	60	S-SİSTEM için / For S-SYSTEM / S-ТИП	TORK VİDA / TORX SCREW / ВИНТЫ TORX
4015-M3.5x12	M3.5x0.6	12	15	5.3	60	S-SİSTEM için / For S-SYSTEM / S-ТИП	TORK VİDA / TORX SCREW / ВИНТЫ TORX
4015-M3.5x14	M3.5x0.6	13.7	15	5.3	60	S-SİSTEM için / For S-SYSTEM / S-ТИП	TORK VİDA / TORX SCREW / ВИНТЫ TORX
1015-M4x8	M4x0.7	8	15	6.8	R	S-SİSTEM için / For S-SYSTEM / S-ТИП	TORK VİDA / TORX SCREW / ВИНТЫ TORX
1015-M4x9	M4x0.7	9	15	6.8	R	S-SİSTEM için / For S-SYSTEM / S-ТИП	TORK VİDA / TORX SCREW / ВИНТЫ TORX
1515-M4x9	M4x0.7	9	15	5.7	50	S-SİSTEM için / For S-SYSTEM / S-ТИП	TORK VİDA / TORX SCREW / ВИНТЫ TORX
1015-M4x11	M4x0.7	10.8	15	6.8	R	S-SİSTEM için / For S-SYSTEM / S-ТИП	TORK VİDA / TORX SCREW / ВИНТЫ TORX
1115-M4x10	M4x0.7	10	15	5.9	R	S-SİSTEM için / For S-SYSTEM / S-ТИП	TORK VİDA / TORX SCREW / ВИНТЫ TORX
1315-M4x11	M4x0.7	11.1	15	5	45	S-SİSTEM için / For S-SYSTEM / S-ТИП	TORK VİDA / TORX SCREW / ВИНТЫ TORX
1415-M4x11	M4x0.7	11	15	5.6	50	S-SİSTEM için / For S-SYSTEM / S-ТИП	TORK VİDA / TORX SCREW / ВИНТЫ TORX
1515-M4x11	M4x0.7	11.1	15	5.6	50	S-SİSTEM için / For S-SYSTEM / S-ТИП	TORK VİDA / TORX SCREW / ВИНТЫ TORX
1615-M4x11	M4x0.7	11.1	15	6	50	S-SİSTEM için / For S-SYSTEM / S-ТИП	TORK VİDA / TORX SCREW / ВИНТЫ TORX
3015-M4x9	M4x0.7	9	15	5.6	50	S-SİSTEM için / For S-SYSTEM / S-ТИП	TORK VİDA / TORX SCREW / ВИНТЫ TORX
3015-M4x11	M4x0.7	11	15	5.6	50	S-SİSTEM için / For S-SYSTEM / S-ТИП	TORK VİDA / TORX SCREW / ВИНТЫ TORX
4015-M4x8	M4x0.7	8	15	5.6	50	S-SİSTEM için / For S-SYSTEM / S-ТИП	TORK VİDA / TORX SCREW / ВИНТЫ TORX
4015-M4x9	M4x0.7	9	15	5.6	50	S-SİSTEM için / For S-SYSTEM / S-ТИП	TORK VİDA / TORX SCREW / ВИНТЫ TORX
4015-M4x10	M4x0.7	10	15	5.6	50	S-SİSTEM için / For S-SYSTEM / S-ТИП	TORK VİDA / TORX SCREW / ВИНТЫ TORX
4015-M4x11	M4x0.7	11	15	5.6	50	S-SİSTEM için / For S-SYSTEM / S-ТИП	TORK VİDA / TORX SCREW / ВИНТЫ TORX
4015-M4x12	M4x0.7	12	15	5.7	50	S-SİSTEM için / For S-SYSTEM / S-ТИП	TORK VİDA / TORX SCREW / ВИНТЫ TORX
4115-M4x12	M4x0.7	12	15	5.6	55	S-SİSTEM için / For S-SYSTEM / S-ТИП	TORK VİDA / TORX SCREW / ВИНТЫ TORX
4515-M4x8	M4x0.7	8	15	5.1	50	S-SİSTEM için / For S-SYSTEM / S-ТИП	TORK VİDA / TORX SCREW / ВИНТЫ TORX
4515-M4x11	M4x0.7	11	15	5.1	50	S-SİSTEM için / For S-SYSTEM / S-ТИП	TORK VİDA / TORX SCREW / ВИНТЫ TORX
4615-M4x11	M4x0.7	11	15	6	50	S-SİSTEM için / For S-SYSTEM / S-ТИП	TORK VİDA / TORX SCREW / ВИНТЫ TORX
1015-M4.5x12	M4.5x0.75	12	15	6.6	50	S-SİSTEM için / For S-SYSTEM / S-ТИП	TORK VİDA / TORX SCREW / ВИНТЫ TORX
1020-M4.5x14	M4.5x0.75	14	20	6.5	45	S-SİSTEM için / For S-SYSTEM / S-ТИП	TORK VİDA / TORX SCREW / ВИНТЫ TORX
1020-M4.5x16	M4.5x0.75	16	20	6.5	45	S-SİSTEM için / For S-SYSTEM / S-ТИП	TORK VİDA / TORX SCREW / ВИНТЫ TORX
1120-M4.5x12	M4.5x0.75	12.1	20	7.9	R	S-SİSTEM için / For S-SYSTEM / S-ТИП	TORK VİDA / TORX SCREW / ВИНТЫ TORX
1515-M4.5x11	M4.5x0.75	11	15	6.4	45	S-SİSTEM için / For S-SYSTEM / S-ТИП	TORK VİDA / TORX SCREW / ВИНТЫ TORX
4015-M4.5x11	M4.5x0.75	11	15	6.4	45	S-SİSTEM için / For S-SYSTEM / S-ТИП	TORK VİDA / TORX SCREW / ВИНТЫ TORX
4020-M4.5x10	M4.5x0.75	10	20	6.5	55	S-SİSTEM için / For S-SYSTEM / S-ТИП	TORK VİDA / TORX SCREW / ВИНТЫ TORX
4020-M4.5x12	M4.5x0.75	12	20	6.5	55	S-SİSTEM için / For S-SYSTEM / S-ТИП	TORK VİDA / TORX SCREW / ВИНТЫ TORX
1020-M5x7.5	M5x0.8	7.5	20	6.5	50	S-SİSTEM için / For S-SYSTEM / S-ТИП	TORK VİDA / TORX SCREW / ВИНТЫ TORX
1020-M5x11	M5x0.8	11	20	6.6	50	S-SİSTEM için / For S-SYSTEM / S-ТИП	TORK VİDA / TORX SCREW / ВИНТЫ TORX
1020-M5x14	M5x0.8	14.1	20	6.8	50	S-SİSTEM için / For S-SYSTEM / S-ТИП	TORK VİDA / TORX SCREW / ВИНТЫ TORX
1120-M5x13	M5x0.8	13	20	7	R	S-SİSTEM için / For S-SYSTEM / S-ТИП	TORK VİDA / TORX SCREW / ВИНТЫ TORX
1615-M5x14	M5x0.8	14	15	7.3	50	S-SİSTEM için / For S-SYSTEM / S-ТИП	TORK VİDA / TORX SCREW / ВИНТЫ TORX
1620-M5x18	M5x0.8	18	20	8.15	50	S-SİSTEM için / For S-SYSTEM / S-ТИП	TORK VİDA / TORX SCREW / ВИНТЫ TORX
1620-M5x22	M5x0.8	22	20	8.15	50	S-SİSTEM için / For S-SYSTEM / S-ТИП	TORK VİDA / TORX SCREW / ВИНТЫ TORX
4420-M5x14	M5x0.8	14	20	6.6	60	S-SİSTEM için / For S-SYSTEM / S-ТИП	TORK VİDA / TORX SCREW / ВИНТЫ TORX
1020-M6x16	M6x1.0	16	20	8.5	50	S-SİSTEM için / For S-SYSTEM / S-ТИП	TORK VİDA / TORX SCREW / ВИНТЫ TORX
1420-M6x16	M6x1.0	16	20	7.6	50	S-SİSTEM için / For S-SYSTEM / S-ТИП	TORK VİDA / TORX SCREW / ВИНТЫ TORX
1520-M6x16	M6x1.0	16	20	8.2	50	S-SİSTEM için / For S-SYSTEM / S-ТИП	TORK VİDA / TORX SCREW / ВИНТЫ TORX
1710-U5-40x12.2	UNC 5-40	12.2	10	5.6	60	S-SİSTEM için / For S-SYSTEM / S-ТИП	TORK VİDA / TORX SCREW / ВИНТЫ TORX
1720-U8-32x10	UNC 8-32	10	20	7.5	60	S-SİSTEM için / For S-SYSTEM / S-ТИП	TORK VİDA / TORX SCREW / ВИНТЫ TORX
1720-U8-32x15	UNC 8-32	15	20	7.5	60	S-SİSTEM için / For S-SYSTEM / S-ТИП	TORK VİDA / TORX SCREW / ВИНТЫ TORX
1707-U4-48x6	UNF 4-48	6	7	3.27	60	S-SİSTEM için / For S-SYSTEM / S-ТИП	TORK VİDA / TORX SCREW / ВИНТЫ TORX
1707-U4-48x6.5	UNF 4-48	6.5	7	3.27	60	S-SİSTEM için / For S-SYSTEM / S-ТИП	TORK VİDA / TORX SCREW / ВИНТЫ TORX
1707-U4-48x8.2	UNF 4-48	8.2	7	3.27	60	S-SİSTEM için / For S-SYSTEM / S-ТИП	TORK VİDA / TORX SCREW / ВИНТЫ TORX

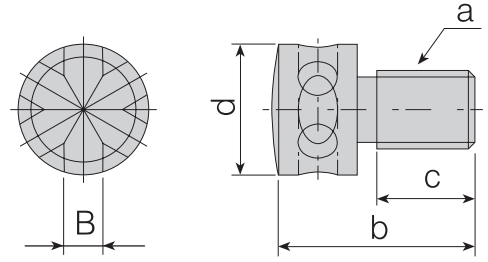

EKSENEL AYAR VIDALARI / AXIAL ADJUSTING SCREWS / ОСЕВОЙ РЕГУЛИРОВОЧНЫЙ ВИНТ

Takım Kodu Ordering Code Код для заказа	Eksenel Ayar Vidaları / Axial Adjusting Screws / Осевой регулировочный винт					Ürün Detayı / Product Detail / Описание	
	a (M)	b	c	d	B		
2600-M4x9.5	M4x0.5	9.5	4	4	1.5	Kartuş için / for Cartridge / Для картриджа	Eksenel Ayar Vida / Axial Adjust Screw / Осевой регулировочный винт
2600-M5x13	M5x0.5	13	7	8	2.5	Kartuş için / for Cartridge / Для картриджа	Eksenel Ayar Vida / Axial Adjust Screw / Осевой регулировочный винт
2600-M6x18	M6x1.0	18	9	10	3.5	Kartuş için / for Cartridge / Для картриджа	Eksenel Ayar Vida / Axial Adjust Screw / Осевой регулировочный винт

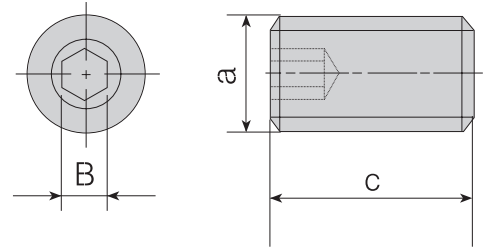
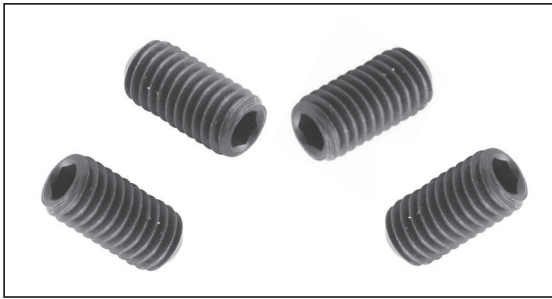

RADYAL AYAR VIDALARI / RADIAL ADJUSTING SCREWS / РЕГУЛИРОВОЧНЫЙ ВИНТ

Takım Kodu Ordering Code Код для заказа	Radial Ayar Vidaları / Radial Adjusting Screws / Регулировочный винт			Ürün Detayı / Product Detail / Описание	
	a (M)	c	B		
2715-M3x4	M3x0.5	4	1.5	KABA BARA için / for ROUGH BORING HEADS ДЛЯ ЧЕРНОВЫХ РАСТОЧНЫХ ГОЛОВОККА- BA BARA için / for ROUGH BORING HEADS	KABA BARA KARTUŞU için / for ROUGH BORING HEADS CARTRIDGE РЕГУЛИРОВОЧНЫЙ ВИНТ РАСТОЧНОЙ ГОЛОВКИКАBA BARA KARTUŞU için / for ROUGH BORING HEADS CARTRIDGE
2715-M3x5	M3x0.5	5	1.5	ДЛЯ ЧЕРНОВЫХ РАСТОЧНЫХ ГОЛОВОККА- BA BARA için / for ROUGH BORING HEADS	РЕГУЛИРОВОЧНЫЙ ВИНТ РАСТОЧНОЙ ГОЛОВКИКАBA BARA KARTUŞU için / for ROUGH BORING HEADS CARTRIDGE
2715-M3x8	M3x0.5	8	1.5	ДЛЯ ЧЕРНОВЫХ РАСТОЧНЫХ ГОЛОВОККА- BA BARA için / for ROUGH BORING HEADS	РЕГУЛИРОВОЧНЫЙ ВИНТ РАСТОЧНОЙ ГОЛОВКИКАBA BARA KARTUŞU için / for ROUGH BORING HEADS CARTRIDGE
2702-M4x4	M4x0.7	4	2	ДЛЯ ЧЕРНОВЫХ РАСТОЧНЫХ ГОЛОВОККА- BA BARA için / for ROUGH BORING HEADS	РЕГУЛИРОВОЧНЫЙ ВИНТ РАСТОЧНОЙ ГОЛОВКИКАBA BARA KARTUŞU için / for ROUGH BORING HEADS CARTRIDGE
2702-M4x10	M4x0.7	10	2	ДЛЯ ЧЕРНОВЫХ РАСТОЧНЫХ ГОЛОВОККА- BA BARA için / for ROUGH BORING HEADS	РЕГУЛИРОВОЧНЫЙ ВИНТ РАСТОЧНОЙ ГОЛОВКИКАBA BARA KARTUŞU için / for ROUGH BORING HEADS CARTRIDGE
2702-M4x12	M4x0.7	12	2	ДЛЯ ЧЕРНОВЫХ РАСТОЧНЫХ ГОЛОВОККА- BA BARA için / for ROUGH BORING HEADS	РЕГУЛИРОВОЧНЫЙ ВИНТ РАСТОЧНОЙ ГОЛОВКИКАBA BARA KARTUŞU için / for ROUGH BORING HEADS CARTRIDGE
2725-M5x6	M5x0.8	5	2.5	ДЛЯ ЧЕРНОВЫХ РАСТОЧНЫХ ГОЛОВОККА- BA BARA için / for ROUGH BORING HEADS	РЕГУЛИРОВОЧНЫЙ ВИНТ РАСТОЧНОЙ ГОЛОВКИКАBA BARA KARTUŞU için / for ROUGH BORING HEADS CARTRIDGE
2725-M5x10	M5x0.8	10	2.5	ДЛЯ ЧЕРНОВЫХ РАСТОЧНЫХ ГОЛОВОККА- BA BARA için / for ROUGH BORING HEADS	РЕГУЛИРОВОЧНЫЙ ВИНТ РАСТОЧНОЙ ГОЛОВКИКАBA BARA KARTUŞU için / for ROUGH BORING HEADS CARTRIDGE
2725-M5x12	M5x0.8	12	2.5	ДЛЯ ЧЕРНОВЫХ РАСТОЧНЫХ ГОЛОВОККА- BA BARA için / for ROUGH BORING HEADS	РЕГУЛИРОВОЧНЫЙ ВИНТ РАСТОЧНОЙ ГОЛОВКИКАBA BARA KARTUŞU için / for ROUGH BORING HEADS CARTRIDGE
2725-M5x14	M5x0.8	14	2.5	ДЛЯ ЧЕРНОВЫХ РАСТОЧНЫХ ГОЛОВОККА- BA BARA için / for ROUGH BORING HEADS	РЕГУЛИРОВОЧНЫЙ ВИНТ РАСТОЧНОЙ ГОЛОВКИКАBA BARA KARTUŞU için / for ROUGH BORING HEADS CARTRIDGE
2703-M6x16	M6x1	16	3	ДЛЯ ЧЕРНОВЫХ РАСТОЧНЫХ ГОЛОВОККА- BA BARA için / for ROUGH BORING HEADS	РЕГУЛИРОВОЧНЫЙ ВИНТ РАСТОЧНОЙ ГОЛОВКИКАBA BARA KARTUŞU için / for ROUGH BORING HEADS CARTRIDGE
2704-M8x25	M8x1.25	25.9	4	ДЛЯ ЧЕРНОВЫХ РАСТОЧНЫХ ГОЛОВОККА- BA BARA için / for ROUGH BORING HEADS	РЕГУЛИРОВОЧНЫЙ ВИНТ РАСТОЧНОЙ ГОЛОВКИКАBA BARA KARTUŞU için / for ROUGH BORING HEADS CARTRIDGE
2704-M8x1x5	M8x1	5	4	İÇTEN SOĞUTMA KANALLI TAKIMLAR için / for COOLANT TOOLS / С ПОДВОДОМ СОЖ	JET TAKIMLAR için / For JET TOOLS / Для Державок с подводом СОЖ
2705-G1/8x5.5	G1/8	5.5	5	İÇTEN SOĞUTMA KANALLI TAKIMLAR için / for COOLANT TOOLS / С ПОДВОДОМ СОЖ	JET TAKIMLAR için / For JET TOOLS / Для Державок с подводом СОЖ

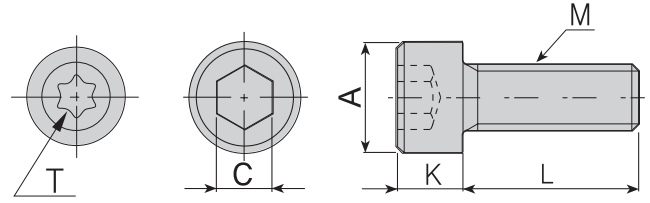

İNBUS CİVATALAR / INBUS SCREWS / ВИНТЫ С ПОТАЙНОЙ ГОЛОВКОЙ

Takım Kodu Ordering Code Код для заказа	M	A	C	K	L	Ürün Detayı / Product Detail / Описание	
						Ürün Detayı / Product Detail / Описание	Ürün Detayı / Product Detail / Описание
2503-M4x10	M4x0.7	7	3	4	10	KANAL KATER VİDASI / SOME GROOVING TOOLS SCREW	ДЛЯ НЕКОТОРЫХ КАНАВОЧНЫХ ДЕРЖАВОК
2525-M3x14	M3X0.5	5.4	2.5	3	14	BARA KARTUŞU için SIKMA VİDASI / for BORING HEADS CARTRIDGE SCREW	ВИНТ ДЛЯ КАРТРИДЖЕЙ РАСТОЧНЫХ ГОЛОВОК
2503-M4x20	M4x0.7	7	3	4	20	BARA KARTUŞU için SIKMA VİDASI / for BORING HEADS CARTRIDGE SCREW	ВИНТ ДЛЯ КАРТРИДЖЕЙ РАСТОЧНЫХ ГОЛОВОК
2503-M4x12	M4x0.7	7	3	4	12	KANAL KATER VİDASI / SOME GROOVING TOOLS SCREW	ДЛЯ НЕКОТОРЫХ КАНАВОЧНЫХ ДЕРЖАВОК
2503-M4x15	M4x0.7	7	3	4	15	BARA KARTUŞU için SIKMA VİDASI / for BORING HEADS CARTRIDGE SCREW	ВИНТ ДЛЯ КАРТРИДЖЕЙ РАСТОЧНЫХ ГОЛОВОК
2504-M5x16	M5x0.8	8.5	4	5	16	KANAL KATER VİDASI / SOME GROOVING TOOLS SCREW	ДЛЯ НЕКОТОРЫХ КАНАВОЧНЫХ ДЕРЖАВОК
2504-M5x12	M5x0.8	8.5	4	5	12	KANAL KATER VİDASI / SOME GROOVING TOOLS SCREW	ДЛЯ НЕКОТОРЫХ КАНАВОЧНЫХ ДЕРЖАВОК
2504-M5x14	M5x0.8	8.5	4	5	14	KANAL KATER VİDASI / SOME GROOVING TOOLS SCREW	ДЛЯ НЕКОТОРЫХ КАНАВОЧНЫХ ДЕРЖАВОК
2504-M5x25	M5x0.8	8.5	4	5	25	BARA KARTUŞU için SIKMA VİDASI / for BORING HEADS CARTRIDGE SCREW	ВИНТ ДЛЯ КАРТРИДЖЕЙ РАСТОЧНЫХ ГОЛОВОК
2505-M6x16	M6x1	10	5	6	16	KANAL KATER VİDASI / SOME GROOVING TOOLS SCREW	ДЛЯ НЕКОТОРЫХ КАНАВОЧНЫХ ДЕРЖАВОК
2505-M6x20	M6x1	10	5	6	20	KANAL KATER VİDASI / SOME GROOVING TOOLS SCREW	ДЛЯ НЕКОТОРЫХ КАНАВОЧНЫХ ДЕРЖАВОК
2505-M6x25	M6x1	10	5	6	25	BLOK BASKI PABUÇ VİDASI / for BLOCK CLAMP SCREW	ВИНТ ДЛЯ ПРИЖИМА БЛОКОВ
2505-M6x30	M6x1	10	5	6	30	BARA KARTUŞU için SIKMA VİDASI / for BORING HEADS CARTRIDGE SCREW	ВИНТ ДЛЯ КАРТРИДЖЕЙ РАСТОЧНЫХ ГОЛОВОК
2306-M8x37	M8x1.25	13	6	6.4	31.5	MONTAJ VİDASI (KAFASI KÜÇÜK) / MOUNTING SCREW (SMALL HEAD)	МОНТАЖНЫЙ ВИНТ (МАЛЕНЬКАЯ ГОЛОВКА)
2405-M8x30	M8x1.25	13	5	5	30	A16 MONTAJ VİDASI (KAFASI KÜÇÜK) / MOUNTING SCREW (SMALL HEAD)	МОНТАЖНЫЙ ВИНТ (МАЛЕНЬКАЯ ГОЛОВКА)
2506-M8x20	M8x1.25	13	6	8	20	KARTUŞ MONTAJ VİDASI / CARTRIDGE MOUNTING SCREW	МОНТАЖНЫЙ ВИНТ ДЛЯ КАРТРИДЖА
2506-M8x30	M8x1.25	13	6	8	30	A16 MONTAJ VİDASI / MOUNTING SCREW	МОНТАЖНЫЙ ВИНТ (МАЛЕНЬКАЯ ГОЛОВКА)
2506-M8x35	M8x1.25	13	6	8	35	BARA KARTUŞU için SIKMA VİDASI / for BORING HEADS CARTRIDGE SCREW	ВИНТ ДЛЯ КАРТРИДЖЕЙ РАСТОЧНЫХ ГОЛОВОК
2406-M8x30	M8x1.25	12	6	8	30	A16 MONTAJ VİDASI / MOUNTING SCREW	МОНТАЖНЫЙ ВИНТ (МАЛЕНЬКАЯ ГОЛОВКА)
2407-M10x30	M10x1.5	16	7	6	30	A16 MONTAJ VİDASI / MOUNTING SCREW	МОНТАЖНЫЙ ВИНТ (МАЛЕНЬКАЯ ГОЛОВКА)
2408-M10x30	M10x1.5	13	8	10	30	A22 MONTAJ VİDASI / MOUNTING SCREW	МОНТАЖНЫЙ ВИНТ (МАЛЕНЬКАЯ ГОЛОВКА)
2508-M10x30	M10x1.5	16	8	10	30	A22 MONTAJ VİDASI / MOUNTING SCREW	МОНТАЖНЫЙ ВИНТ (МАЛЕНЬКАЯ ГОЛОВКА)
2508-M10x40	M10x1.5	16	8	10	40	BARA KARTUŞU için SIKMA VİDASI / for BORING HEADS CARTRIDGE SCREWS	ВИНТ ДЛЯ КАРТРИДЖЕЙ РАСТОЧНЫХ ГОЛОВОК
2408-M12x35	M12x1.75	18	8	7	35	A27 MONTAJ VİDASI / MOUNTING SCREW	МОНТАЖНЫЙ ВИНТ (МАЛЕНЬКАЯ ГОЛОВКА)
2510-M12x35	M12x1.75	18	10	12	35	A27 MONTAJ VİDASI / MOUNTING SCREW	МОНТАЖНЫЙ ВИНТ (МАЛЕНЬКАЯ ГОЛОВКА)
2514-M16x35	M16x2.0	23.7	14	16	35	A32 MONTAJ VİDASI / MOUNTING SCREW	МОНТАЖНЫЙ ВИНТ (МАЛЕНЬКАЯ ГОЛОВКА)
AAV-11-U5-40x4.5	UNC 5-40	5.4	T10	2.8	4.5	16 ER/L, 16 IR/L ALTLIK VİDASI / SHIM SCREW	Винт опорной пластины
AAV-12-U8-32x5.5	UNC 8-32	6.7	T20	3.8	5.5	22 ER/L, 22 IR/L ALTLIK VİDASI / SHIM SCREW	Винт опорной пластины
AAV-15-M5x5.7	M5X0.8	8.5	T20	3.15	5.7	27 ER/L, 27 IR/L ALTLIK VİDASI / SHIM SCREW	Винт опорной пластины

SEGMAN / RING / КОЛЬЦО

Ürün Resmi Product Picture Изображение	SEGMAN / RING / КОЛЬЦО	
	Ürün Kodu Product Code / Код	Ürün Detayı / Product Detail / Описание
	ACS-01	C-SİSTEM için / For C-SYSTEM / C-ТИП TNGN, CNGN, DNGN, SNGN SEGMANI / КОЛЬЦО
	AS-01	T-M-SİSTEM için / For T-M-SYSTEM / T-M ТИП AKV-30-M6x22 SEGMANI / КОЛЬЦО
	AS-02	T SİSTEM için / For T SYSTEM / ТТИП AKV-19-M7x25 SEGMANI / КОЛЬЦО

ORING / ORING / КОЛЬЦО

Ürün Resmi Product Picture Изображение	ORING / ORING / КОЛЬЦО		
	Ürün Kodu Product Code / Код	Ürün Detayı / Product Detail / Описание	
	AOR-01	P-SİSTEM için / For P-SYSTEM / P-ТИП	ORING
	AXR-01	T-P SİSTEM için / For T-P SYSTEM / T-P-ТИП	ORING

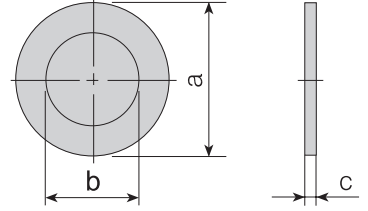
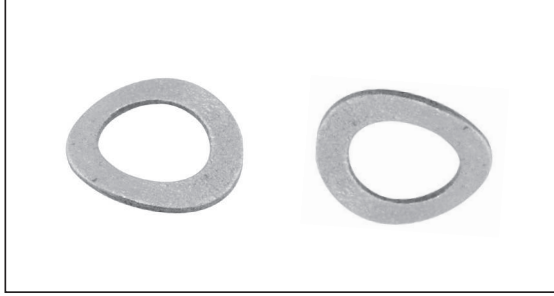

BASKI VE ALTLIK VİDASI PULU / STAMP / ШАЙБА

Takım Kodu Ordering Code Код для заказа	a	b	c	Ürün Detayı / Product Detail / Описание	
				PUL/STAMP/ШАЙБА	BASKI PULU / STAMP / ШАЙБА
ABPL-01	10.5	6.2	0.5	PUL/STAMP/ШАЙБА	BASKI PULU / STAMP / ШАЙБА
ABPL-02	12.75	7.1	0.45	PUL/STAMP/ШАЙБА	BASKI PULU / STAMP / ШАЙБА
ABPL-03	5.3	3.2	0.5	PUL/STAMP/ШАЙБА	TER - TIR 16 ER/EL - İR/İL ALTLIK VİDASI PULU / SHIM SCREW RING / ВИНТ ОПОРНОЙ ПЛАСТИНЫ
ABPL-04	6.9	4.2	0.5	PUL/STAMP/ШАЙБА	TER - TIR 22 ER/EL - İR/İL ALTLIK VİDASI PULU / SHIM SCREW RING / ВИНТ ОПОРНОЙ ПЛАСТИНЫ
ABPL-05	8.5	5	0.5	PUL/STAMP/ШАЙБА	TER - TIR 27 ER/EL - İR/İL ALTLIK VİDASI PULU / SHIM SCREW RING / ВИНТ ОПОРНОЙ ПЛАСТИНЫ

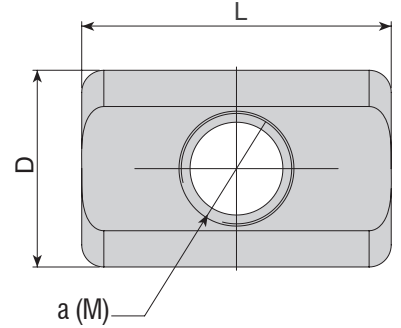



BARA PABUÇLARI / BORING HEADS CARTRIDGE / КАРТРИДЖЕЙ РАСТОЧНЫХ ГОЛОВОК

Takım Kodu Ordering Code Код для заказа	a (M)	D	L	Ürün Detayı / Product Detail / Описание	
				KABA BARA için / for ROUGH BORING HEADS / ДЛЯ ЧЕРНОВЫХ РАСТОЧНЫХ ГОЛОВОК	ABHR-D16x42-W16-L90
ABKS-D16	M3x0.5	4.9	6	KABA BARA için / for ROUGH BORING HEADS / ДЛЯ ЧЕРНОВЫХ РАСТОЧНЫХ ГОЛОВОК	ABHR-D16x42-W16-L90
ABKS-D20	M4x0.7	5.9	9	ABA BARA için / for ROUGH BORING HEADS / ДЛЯ ЧЕРНОВЫХ РАСТОЧНЫХ ГОЛОВОК	ABHR-D20x50-W20-L100
ABKS-D25	M4x0.7	5.9	12	KABA BARA için / for ROUGH BORING HEADS / ДЛЯ ЧЕРНОВЫХ РАСТОЧНЫХ ГОЛОВОК	ABHR-D25x60-W20-L110
ABKS-D32	M5x0.8	8.9	14	KABA BARA için / for ROUGH BORING HEADS / ДЛЯ ЧЕРНОВЫХ РАСТОЧНЫХ ГОЛОВОК	ABHR-D32x64-W25-L120
ABKS-D40	M6x1	10.9	18	KABA BARA için / for ROUGH BORING HEADS / ДЛЯ ЧЕРНОВЫХ РАСТОЧНЫХ ГОЛОВОК	ABHR-D40x80-W32-L140
ABKS-D50	M8x1.25	13.9	28	KABA BARA için / for ROUGH BORING HEADS / ДЛЯ ЧЕРНОВЫХ РАСТОЧНЫХ ГОЛОВОК	ABHR-D50x100-W32-L160
ABKS-D63	M10x1.5	15.9	35	KABA BARA için / for ROUGH BORING HEADS / ДЛЯ ЧЕРНОВЫХ РАСТОЧНЫХ ГОЛОВОК	ABHR-D63x80-W32-L140, ABHR-D63x130-W40-L200
ABKS-D80	M12x1.75	17.9	45	KABA BARA için / for ROUGH BORING HEADS / ДЛЯ ЧЕРНОВЫХ РАСТОЧНЫХ ГОЛОВОК	ABHR-D80x140-W40-L210, ABHR-D80x140-W40-L210-B

Ürün Resmi Product Picture Изображение	KESME ve KANAL LAMA AÇMA BLOK PABUÇLARI / BLOCKS FOR PARTING AND DEEP GROOVING BLADES CLAMPS ПРИЖИМ БЛОКА СМЕННОГО ЛЕЗВИЯ ДЛЯ ОТРЕЗКИ И ОБРАБОТКИ ГЛУБОКИХ КАНАВOK		
	Ürün Kodu Product Code / Код	Ürün Detayı / Product Detail / Описание	
	ABK-01	LAMA BLOĞU için / For BLADE BLOCK / ДЛЯ БЛОКА СМЕННОГО ЛЕЗВИЯ	ALBU-20-26 BASKI PABUCU / CLAMP / Прижим
	ABK-02	LAMA BLOĞU için / For BLADE BLOCK / ДЛЯ БЛОКА СМЕННОГО ЛЕЗВИЯ	ALBU-25-26 BASKI PABUCU / CLAMP / Прижим
	ABK-03	LAMA BLOĞU için / For BLADE BLOCK / ДЛЯ БЛОКА СМЕННОГО ЛЕЗВИЯ	ALBU-20-32 BASKI PABUCU / CLAMP / Прижим
	ABK-04	LAMA BLOĞU için / For BLADE BLOCK / ДЛЯ БЛОКА СМЕННОГО ЛЕЗВИЯ	ALBU-25-32, ALBU-32-32 BASKI PABUCU / CLAMP / Прижим

Ürün Resmi Product Picture Изображение	LAMA ANAHTARI / BLADE KEY / КЛЮЧ ДЛЯ ОТРЕЗНОГО НOЖА		
	Ürün Kodu Product Code / Код	Ürün Detayı / Product Detail / Описание	
	ALA-01	AKL LAMA ANAHTARI / for BLADE KEY / КЛЮЧ ДЛЯ ОТРЕЗНОГО НOЖА	
	ALA-02	AKL LAMA ANAHTARI / for BLADE KEY / КЛЮЧ ДЛЯ ОТРЕЗНОГО НOЖА	

Ürün Resmi Product Picture Изображение	ALYAN ANAHTARLARI / ALLEN KEYS / ШЕСТИГРАННЫЕ КЛЮЧИ		
	Ürün Kodu Product Code / Код	Ürün Detayı / Product Detail / Описание	
	AAL-01-2	2 mm	ALYAN ANAHTARI / ALLEN KEYS / ШЕСТИГРАННЫЕ КЛЮЧИ
	AAL-02-2.5	2.5 mm	ALYAN ANAHTARI / ALLEN KEYS / ШЕСТИГРАННЫЕ КЛЮЧИ
	AAL-03-3	3 mm	ALYAN ANAHTARI / ALLEN KEYS / ШЕСТИГРАННЫЕ КЛЮЧИ
	AAL-05-4	4 mm	ALYAN ANAHTARI / ALLEN KEYS / ШЕСТИГРАННЫЕ КЛЮЧИ
	AAL-07-5	5 mm	ALYAN ANAHTARI / ALLEN KEYS / ШЕСТИГРАННЫЕ КЛЮЧИ
	AAL-08-6	6 mm	ALYAN ANAHTARI / ALLEN KEYS / ШЕСТИГРАННЫЕ КЛЮЧИ
	AAL-09-1.5	1.5 mm	ALYAN ANAHTARI / ALLEN KEYS / ШЕСТИГРАННЫЕ КЛЮЧИ
	AAL-11-8	8 mm	ALYAN ANAHTARI / ALLEN KEYS / ШЕСТИГРАННЫЕ КЛЮЧИ
	AAL-12-10	10 mm	ALYAN ANAHTARI / ALLEN KEYS / ШЕСТИГРАННЫЕ КЛЮЧИ

Ürün Resmi Product Picture Изображение	TORK ANAHTARLARI / TORX KEYS / Торх Ключ		
	Ürün Kodu Product Code / Код	Ürün Detayı / Product Detail / Описание	
	82-T06	T06 TORK ANAHTARI / TORX KEY / Торх Ключ	
	82-T07	T07 TORK ANAHTARI / TORX KEY / Торх Ключ	
	82-T08	T08 TORK ANAHTARI / TORX KEY / Торх Ключ	
	82-T10	T10 TORK ANAHTARI / TORX KEY / Торх Ключ	
	80-T15	T15 TORK ANAHTARI / TORX KEY / Торх Ключ	
	80-T20	T20 TORK ANAHTARI / TORX KEY / Торх Ключ	
	81-T15	T15 T-TİP TORK ANAHTARI / T-TYPE TORX KEY / T-TYP-Tорх Ключ	
	81-T20	T20 T-TİP TORK ANAHTARI / T-TYPE TORX KEY / T-TYP-Tорх Ключ	

KOD / CODE	AÇIKLAMA / DESCRIPTION	СОДЕРЖАНИЕ	S.N. / P.N. СТР.
A/PTFNR/L ..	Boring Bars	Расточных Державок	92
A/SCLCR/L ..	Boring Bars SET	Наборы Расточных Державок	96
A/SDUCR/L ..	Boring Bars SET	Наборы Расточных Державок	99
AAKT-IG-R/L ..	Face External Grooving Tool Holders	Державки для Обработки Торцевых Канавок	164
AAKT-KG-R/L ..	Face External Grooving Tool Holders	Державки для Обработки Торцевых Канавок	163
AAKT-K-R/L ..	Face External Grooving Tool Holders	Державки для Обработки Торцевых Канавок	162
AAKT-SGC-T-R/L ..	Face External Grooving Tool Holders	Державки для Обработки Торцевых Канавок	164
AAKT-WGX24-T-R/L ..	Face External Grooving Tool Holders	Державки для Обработки Торцевых Канавок	165
AAKT-ZCC2-R/L ..	Face External Grooving Tool Holders	Державки для Обработки Торцевых Канавок	163
ABHF ..	Adjustable Finish Boring Heads	КОРПУС РЕГУЛИРУЕМОЙ РАСТОЧНОЙ ГОЛОВКИ ДЛЯ ЧИСТОГО ТОЧЕНИЯ	227
ABHR ..	Adjustable Rough Boring Heads	Регулируемые Расточные Головки для Чернового Точения	231
ABHRS ..	Adjustable Rough Boring Heads Body	Корпус Регулируемой Расточной Головки для Чернового Точения	232
ACBM ..	Countersink Open Milling Tools	Зенковка для Отверстий	239
ACM ..	Chamfering End Mills	Концевые Фрезы Для Снятия Фаски (Зенковки)	237
ACM45-SP..	Chamfering End Mills	Концевые Фрезы Для Снятия Фаски (Зенковки)	238
ACPBT-..	Pipe Beveling Tools	Торцевочная Головка для Цилиндрических Заготовок	131
ADCR	Drill Chamfering Ring Tools	Кольца для Снятия Фаски	218
ADKT-123-R/L ..	External Grooving Tool Holders	Державки для Обработки Наружных Канавок	149
ADKT-123-S-R/L ..	External Grooving (Swiss Type) Tool Holders	Державки для Обработки Наружных Канавок для Токарных Станков Швейцарского Типа	161
ADKT-151.22-R/L ..	External Grooving Tool Holders	Державки для Обработки Наружных Канавок	150
ADKT-151.23-R/L ..	External Grooving Tool Holders	Державки для Обработки Наружных Канавок	150
ADKT-154.91-R/L ..	External Grooving Tool Holders	Державки для Обработки Наружных Канавок	151
ADKT-ARN-R/L ..	External Grooving Tool Holders	Державки для Обработки Наружных Канавок	151
ADKT-CD-R/L ..	External Grooving Tool Holders	Державки для Обработки Наружных Канавок	157
ADKT-GB-R/L ..	External Grooving Tool Holders	Державки для Обработки Наружных Канавок	154
ADKT-GP-R/L ..	External Grooving Tool Holders	Державки для Обработки Наружных Канавок	156
ADKT-GY2-R/L ..	External Grooving Tool Holders	Державки для Обработки Наружных Канавок	157
ADKT-H22-R/L ..	External Grooving Tool Holders	Державки для Обработки Наружных Канавок	154
ADKT-HK-R/L ..	External Grooving Tool Holders	Державки для Обработки Наружных Канавок	145
ADKT-H-R/L ..	External Grooving Tool Holders	Державки для Обработки Наружных Канавок	144
ADKT-HS223-R/L ..	External Grooving Tool Holders	Державки для Обработки Наружных Канавок	145
ADKT-IDC-R/L ..	External Grooving Tool Holders	Державки для Обработки Наружных Канавок	148
ADKT-IGI-R/L ..	External Grooving Tool Holders	Державки для Обработки Наружных Канавок	148
ADKT-IG-R/L ..	External Grooving Tool Holders	Державки для Обработки Наружных Канавок	148
ADKT-IGTN-R/L ..	External Grooving Tool Holders	Державки для Обработки Наружных Канавок	148
ADKT-I-R/L ..	External Grooving Tool Holders	Державки для Обработки Наружных Канавок	148
ADKT-I-R/L ..S	External Grooving (Swiss Type) Tool Holders	Державки для Обработки Наружных Канавок для Токарных Станков Швейцарского Типа	159
ADKT-ITG-R/L ..	External Grooving Tool Holders	Державки для Обработки Наружных Канавок	147
ADKT-KG-R/L ..	External Grooving Tool Holders	Державки для Обработки Наружных Канавок	143
ADKT-KG-R/L ..S	External Grooving (Swiss Type) Tool Holders	Державки для Обработки Наружных Канавок для Токарных Станков Швейцарского Типа	160
ADKT-KM-R/L ..	External Grooving Tool Holders	Державки для Обработки Наружных Канавок	147
ADKT-K-R/L ..	External Grooving Tool Holders	Державки для Обработки Наружных Канавок	142
ADKT-K-R/L ..-H	External Grooving Tool Holders With Coolant Tools	Externe Nutwerkzeughalter Mit Kühlwerkzeug	143
ADKT-K-R/L ..S	External Grooving (Swiss Type) Tool Holders	Державки для Обработки Наружных Канавок для Токарных Станков Швейцарского Типа	160

KOD / CODE	AÇIKLAMA / DESCRIPTION	СОДЕРЖАНИЕ	S.N. / P.N. СТР.
ADKT-LGC-R/L ..	External Grooving Tool Holders	Державки для Обработки Наружных Канавок	153
ADKT-RD-R/L ..	External Grooving Tool Holders	Державки для Обработки Наружных Канавок	153
ADKT-RD-R/L ..-S	External Grooving (Swiss Type) Tool Holders	Державки для Обработки Наружных Канавок для Токарных Станков Швейцарского Типа	158
ADKT-SGC-T-R/L ..	Face External Grooving Tool Holders	Державки для Обработки Торцевых Канавок	164
ADKT-SWC-R/L ..	External Grooving Tool Holders	Державки для Обработки Наружных Канавок	157
ADKT-TD-R/L ..	External Grooving Tool Holders	Державки для Обработки Наружных Канавок	152
ADKT-TD-R/L ..-S	External Grooving (Swiss Type) Tool Holders	Корпус Регулируемой Расточной Головки для Чернового Точения	158
ADKT-TD-R/L..-H	External Grooving Tool Holders With Coolant Tools	Externe Nutwerkzeughalter Mit Kühlwerkzeug	152
ADKT-TG-R/L ..	External Grooving Tool Holders	Державки для Обработки Наружных Канавок	155
ADKT-TGF-R/L ..	External Grooving Tool Holders	Державки для Обработки Наружных Канавок	155
ADKT-TG-R/L ..-S	External Grooving (Swiss Type) Tool Holders	Корпус Регулируемой Расточной Головки для Чернового Точения	161
ADKT-WGX..-R/L ..	External Grooving Tool Holders	Державки для Обработки Наружных Канавок	156
ADKT-WGX..-R/L ..S	External Grooving (Swiss Type) Tool Holders	Корпус Регулируемой Расточной Головки для Чернового Точения	161
ADKT-ZCC1-R/L ..	External Grooving Tool Holders	Державки для Обработки Наружных Канавок	145
ADKT-ZCC2-R/L ..	External Grooving Tool Holders	Державки для Обработки Наружных Канавок	146
ADKT-ZCC2-R/L ..S	External Grooving (Swiss Type) Tool Holders	Корпус Регулируемой Расточной Головки для Чернового Точения	159
AEKR/L ..	Economic Cutting Tools	MULTI TOOL - Сверление	224
AEM90-3P..	End Mills	Концевые Фрезы	266
AEM90-3P..	Modular End Mills	Сменные Фрезерные Головки (Крепление под Резьбу)	287
AEM90-4N..	End Mills	Концевые Фрезы	266
AEM90-AD..	End Mills	Концевые Фрезы	240
AEM90-AD..	Modular End Mills	Сменные Фрезерные Головки (Крепление под Резьбу)	282
AEM90-AN..	End Mills	Концевые Фрезы	242
AEM90-AO..	End Mills	Концевые Фрезы	249
AEM90-AO..	Modular End Mills	Сменные Фрезерные Головки (Крепление под Резьбу)	283
AEM90-AP..	End Mills	Концевые Фрезы	244
AEM90-AP..	Modular End Mills	Сменные Фрезерные Головки (Крепление под Резьбу)	283
AEM90-AX..	End Mills	Концевые Фрезы	250
AEM90-AX..	Modular End Mills	Сменные Фрезерные Головки (Крепление под Резьбу)	282
AEM90-AZ..	End Mills	Концевые Фрезы	252
AEM90-BD..	End Mills	Концевые Фрезы	253
AEM90-BD..-H	Modular End Mills (Screw Type Tools)	Сменные Фрезерные Головки (Крепление под Резьбу)	253
AEM90-DC..	Modular End Mills	Сменные Фрезерные Головки (Крепление под Резьбу)	284
AEM90-ED..	End Mills	Концевые Фрезы	254
AEM90-LO-H..	End Mills	Концевые Фрезы	256
AEM90-LO	End Mills	Концевые Фрезы	257
AEM90-LN..	End Mills	Концевые Фрезы	255
AEM90-R390..	End Mills	Концевые Фрезы	257
AEM90-R390..	Modular End Mills	Сменные Фрезерные Головки (Крепление под Резьбу)	258
AEM90-RT..	End Mills	Концевые Фрезы	258
AEM90-RT..	Modular End Mills	Сменные Фрезерные Головки (Крепление под Резьбу)	285
AEM90-SE..	End Mills	Концевые Фрезы	259
AEM90-SO..	End Mills	Концевые Фрезы	259
AEM90-SPGT..	End Mills	Концевые Фрезы	261
AEM90-TNG..	End Mills	Концевые Фрезы	286
AEM90-TNG..-H	Modular End Mills (Screw Type Tools)	Сменные Фрезерные Головки (Крепление под Резьбу)	260
AEM90-VC2205..-H	End Mills	Концевые Фрезы	261

KOD / CODE	AÇIKLAMA / DESCRIPTION	СОДЕРЖАНИЕ	S.N. / P.N. СТР.	KOD / CODE	AÇIKLAMA / DESCRIPTION	СОДЕРЖАНИЕ	S.N. / P.N. СТР.
AEM90-WN..	End Mills	Концевые Фрезы	262	AFM88-SN..	Face Milling	Торцевые Фрезы	325
AEM90-WN..	Modular End Mills	Сменные Фрезерные Головки (Крепление под Резьбу)	262	AFM89-SN..	Face Milling	Торцевые Фрезы	328
AEM90-WNG.. -H	End Mills	Концевые Фрезы	262	AFM90(L)-LN..	Face Milling	Торцевые Фрезы	335
AEM90-XC..	End Mills	Концевые Фрезы	263	AFM90(S)-SD..	Face Milling	Торцевые Фрезы	342
AEM90-XD..	End Mills	Концевые Фрезы	263	AFM90-3P..	Face Milling	Торцевые Фрезы	350
AEM90-XN..-H	Modular End Mills (Screw Type Tools)	Сменные Фрезерные Головки (Крепление под Резьбу)	287	AFM90-490..	Face Milling	Торцевые Фрезы	341
AEM90-XN..	End Mills	Концевые Фрезы	264	AFM90-4N..	Face Milling	Торцевые Фрезы	350
AEM90-XO..	End Mills	Концевые Фрезы	264	AFM90-6N..	Face Milling	Торцевые Фрезы	351
AEM90-ZC..	End Mills	Концевые Фрезы	265	AFM90-AD..	Face Milling	Торцевые Фрезы	329
AEM90-ZP..	End Mills	Концевые Фрезы	265	AFM90-AN..	Face Milling	Торцевые Фрезы	330
AEM95(C)-XD..	Modular End Mills	Сменные Фрезерные Головки (Крепление под Резьбу)	288	AFM90-AO..	Face Milling	Торцевые Фрезы	335
AEMR(C)-RD..	Face and Copy End Mills	Концевые Радиусные Фрезы	269	AFM90-AP..	Face Milling	Торцевые Фрезы	332
AEMR-QP..	Face and Copy Mills	Концевые Радиусные Фрезы	270	AFM90-AX..	Face Milling	Торцевые Фрезы	333
AEMR-QP..	Modular End Mills	Сменные Фрезерные Головки (Крепление под Резьбу)	293	AFM90-BD..	Face Milling	Торцевые Фрезы	334
AEMR-RC..	Modular End Mills	Сменные Фрезерные Головки (Крепление под Резьбу)	291	AFM90C-TP..	Face Milling	Торцевые Фрезы	359
AEMR-RD..	Face and Copy Mills	Концевые Радиусные Фрезы	269	AFM90-LO..	Face Milling	Торцевые Фрезы	339
AEMR-RD..	Modular End Mills	Сменные Фрезерные Головки (Крепление под Резьбу)	291	AFM90-LO..-H	Face Milling	Торцевые Фрезы	334
AEMR-RP..	Face and Copy Mills	Концевые Радиусные Фрезы	267	AFM90-R290..	Face Milling	Торцевые Фрезы	340
AEMR-RP..	Modular End Mills	Сменные Фрезерные Головки (Крепление под Резьбу)	289	AFM90-R390..	Face Milling	Торцевые Фрезы	340
AEMR-RP..	Modular End Mills (Screw Type Tools)	Сменные Фрезерные Головки (Крепление под Резьбу)	292	AFM90-RT..	Face Milling	Торцевые Фрезы	341
AEMR-RY..	Face and Copy End Mills	Концевые Радиусные Фрезы	268	AFM90-SE..	Face Milling	Торцевые Фрезы	343
AEMR-RY..	Modular End Mills	Сменные Фрезерные Головки (Крепление под Резьбу)	290	AFM90-SP..	Face Milling	Торцевые Фрезы	344
AEMRC-RD..	Modular End Mills (Screw Type Tools)	Сменные Фрезерные Головки (Крепление под Резьбу)	290	AFM90-TN..	Face Milling	Торцевые Фрезы	345
AET	Eccentric Adaptor For U-Drill	Эксцентрический Адаптер для Сверел	220	AFM90-TP..	Face Milling	Торцевые Фрезы	346
AFM40-NN..	Face Milling	Торцевые Фрезы	315	AFM90-VC2205.. -H	Face Milling	Торцевые Фрезы	347
AFM42C-XD..	Face Milling	Торцевые Фрезы	312	AFM90-WN..	Face Milling	Торцевые Фрезы	348
AFM43(C)-OD..	Face Milling	Торцевые Фрезы	312	AFM90-WNG0.. -H	Face Milling	Торцевые Фрезы	347
AFM43(C)-OF..	Face Milling	Торцевые Фрезы	313	AFM90-XN..	Face Milling	Торцевые Фрезы	349
AFM43-ON..	Face Milling	Торцевые Фрезы	314	AFM90-XO..	Face Milling	Торцевые Фрезы	349
AFM44-ON..	Face Milling	Торцевые Фрезы	314	AFMR(C)-RD..	Face and Copy Milling	Торцевые и Копировальные Фрезы	353
AFM45(L)-HN..	Face Milling	Торцевые Фрезы	315	AFMR(C)-RO..	Face and Copy Milling	Торцевые и Копировальные Фрезы	354
AFM45(L)-SE..	Face Milling	Торцевые Фрезы	316	AFMR-QP..	Face and Copy Milling	Торцевые и Копировальные Фрезы	356
AFM45(S)-SE	Face Milling	Торцевые Фрезы	316	AFMR-RC..	Face and Copy Milling	Торцевые и Копировальные Фрезы	352
AFM45-SE..	Face Milling	Торцевые Фрезы	317	AFMR-RP..	Face and Copy Milling	Торцевые и Копировальные Фрезы	355
AFM45C(L)-HN..	Face Milling	Торцевые Фрезы	357	AFMR-RY..	Face and Copy Milling	Торцевые и Копировальные Фрезы	255
AFM45C(L)-SN..	Face Milling	Торцевые Фрезы	319	AHFM(C)-JD..	High Feed Milling Tools	Высокопроизводительные Торцевые Фрезы	297
AFM45C-ON..	Face Milling	Торцевые Фрезы	322	AHFM(C)-SD..	High Feed End Mills	Высокопроизводительные Концевые Фрезы	366
AFM45C-XN..	Face Milling	Торцевые Фрезы	357	AHFM(C)-SD..	High Feed Milling Tools	Высокопроизводительные Торцевые Фрезы	279
AFM45-NN..	Face Milling	Торцевые Фрезы	316	AHFM(C)-SD..	Modular High Feed End Mills	Hochvorschubenschraubfräser	299
AFM45-ON..	Face Milling	Торцевые Фрезы	321	AHFM(C)-WD..	High Feed End Mills	Высокопроизводительные Концевые Фрезы	279
AFM45S-SE..	Face Milling	Торцевые Фрезы	318	AHFM(C)-WD..	High Feed Milling Tools	Высокопроизводительные Торцевые Фрезы	280
AFM45-SA..	Face Milling	Торцевые Фрезы	320	AHFM(L)-WN..	High Feed Milling Tools	Высокопроизводительные Торцевые Фрезы	361
AFM45-SN..	Face Milling	Торцевые Фрезы	323	AHFM-BL..	High Feed End Mills	Высокопроизводительные Концевые Фрезы	276
AFM45-XN..	Face Milling	Торцевые Фрезы	322	AHFM-BL..	High Feed Milling Tools	Высокопроизводительные Торцевые Фрезы	360
AFM66-PN..	Face Milling	Торцевые Фрезы	323	AHFM-BL..	Modular High Feed End Mills	Высокопроизводительные Сменные Фрезерные Головки	293
AFM67-PN..	Face Milling	Торцевые Фрезы	324	AHFM-BN..	High Feed End Mills	Высокопроизводительные Концевые Фрезы	270
AFM75-AP..	Face Milling	Торцевые Фрезы	324	AHFM-C-JD..	High Feed End Mills	Высокопроизводительные Концевые Фрезы	364
AFM75C-SP..	Face Milling	Торцевые Фрезы	358	AHFM-C-JD..	Modular High Feed End Mills	Высокопроизводительные Торцевые Фрезы	297
AFM75-XO..	Face Milling	Торцевые Фрезы	325	AHFM-C-WD..	Modular High Feed End Mills	Высокопроизводительные Торцевые Фрезы	302
AFM88C-SN..	Face Milling	Торцевые Фрезы	326	AHFM-ED..	Modular High Feed End Mills	Высокопроизводительные Торцевые Фрезы	294
				AHFM-EN..	High Feed End Mills	Высокопроизводительные Концевые Фрезы	273

KOD / CODE	AÇIKLAMA / DESCRIPTION	СОДЕРЖАНИЕ	S.N. / P.N. СТР.	KOD / CODE	AÇIKLAMA / DESCRIPTION	СОДЕРЖАНИЕ	S.N. / P.N. СТР.
AHFM-EN..	High Feed Milling Tools	Высокопроизводительные Торцевые Фрезы	360	AIKT-RD-R/L ..	Internal Grooving Tool Holders	Державки для Обработки Внутренних Канавок	177
AHFM-EN..	Modular High Feed End Mills	Высокопроизводительные Сменные Фрезерные Головки	295	AIKT-SGC-R ..	Internal Grooving Tool Holders	Державки для Обработки Внутренних Канавок	183
AHFM-EO..	High Feed End Mills	Высокопроизводительные Концевые Фрезы	271	AIKT-TD-R/L ..	Internal Grooving Tool Holders	Державки для Обработки Внутренних Канавок	178
AHFM-EP..	High Feed End Mills	Высокопроизводительные Концевые Фрезы	271	AIKT-TG-R/L ..	Internal Grooving Tool Holders	Державки для Обработки Внутренних Канавок	181
AHFM-EP..	High Feed Milling Tools	Высокопроизводительные Торцевые Фрезы	271	AIKT-ZCC2-R/L ..	Internal Grooving Tool Holders	Державки для Обработки Внутренних Канавок	182
AHFM-EP..	Modular High Feed End Mills	Высокопроизводительные Торцевые Фрезы	294	AKCR ..	Adjustable Rough Boring Heads Cartridge	Картриджи Регулируемой Расточной Головки для Чернового Точения	233
AHFM-JD..	High Feed Milling Tools	Высокопроизводительные Торцевые Фрезы	362	AKL-123 ..	Blades	Ножи	167
AHFM-JD..	Modular High Feed End Mills	Высокопроизводительные Торцевые Фрезы	296	AKL-K ..	Blades	Ножи	168
AHFM-LN..	High Feed End Mills	Высокопроизводительные Концевые Фрезы	275	AKL-SP ..	Blades	Ножи	169
AHFM-LN..	Modular High Feed End Mills	Высокопроизводительные Торцевые Фрезы	295	AKL-SX ..	Blades	Ножи	169
AHFM-LN0303.. -H	Modular End Mills	Сменные Фрезерные Головки (Крепление под Резьбу)	362	AKL-ZCC2 ..	Blades	Ножи	168
AHFM-LN0303.. -H	Modular (Screw Type) Highfeed End Mills	Сменные Фрезерные Головки (Крепление под Резьбу)	295	AKL-I ..	Blades	Ножи	167
AHFM-LN0303.. -H	High Feed Milling Tools	Высокопроизводительные Торцевые Фрезы	275	AKL-SGC ..	Blades	Ножи	166
AHFM-LO..	High Feed End Mills	Высокопроизводительные Концевые Фрезы	275	AKL-TD ..	Blades	Ножи	166
AHFM-LO..	High Feed Milling Tools	Высокопроизводительные Торцевые Фрезы	361	AKSR ..	Adjustable Rough Boring Heads Cartridge	Картриджи Регулируемой Расточной Головки для Чернового Точения	233
AHFM-LO..	Modular High Feed End Mills	Высокопроизводительные Торцевые Фрезы	296	ALBU ..	Blocks For Blades	Блоки к Сменным Ножам	170
AHFM-LP..	High Feed End Mills	Высокопроизводительные Концевые Фрезы	276	ALBU-H ..	Blocks For Blades	Блоки к Сменным Ножам	170
AHFM-SD..	Modular High Feed End Mills	Высокопроизводительные Торцевые Фрезы	297	ALKT-ZCC2-R/L ..	Face External Grooving Tool Holders	Державки для Обработки Торцевых Канавок	165
AHFM-SO..	High Feed End Mills	Высокопроизводительные Концевые Фрезы	277	APMR-BNM..	Ball Nose End Mills	Сферические Концевые Фрезы	304
AHFM-SO..	High Feed Milling Tools	Высокопроизводительные Концевые Фрезы	365	APMR-BNM.. -H	Modular (Screw Type) End Mills	S-Тип Сменные Сферические Фрезерные Головки (Крепление Под Резьбу)	306
AHFM-SO..	Modular High Feed End Mills	Высокопроизводительные Торцевые Фрезы	300	APMR-P32..	Ball Nose End Mills	Сферические Концевые Фрезы	305
AHFM-SP..	High Feed End Mills	Высокопроизводительные Концевые Фрезы	274	APMR-P32..	Ball Nose Modular End Mills	Сферические Фрезерные Головки (Крепление под Резьбу)	306
AHFM-SP..	High Feed Milling Tools	Высокопроизводительные Концевые Фрезы	363	APMR-RO..	Ball Nose End Mills	Сферические Концевые Фрезы	304
AHFM-SP..	Modular High Feed End Mills	Высокопроизводительные Торцевые Фрезы	298	APMR-SwB..	Ball Nose Modular End Mills	Сферические Фрезерные Головки (Крепление под Резьбу)	307
AHFM-SP-H..	High Feed End Mills	Высокопроизводительные Концевые Фрезы	274	APMR-XP..	Ball Nose End Mills	Сферические Концевые Фрезы	305
AHFM-WN..	High Feed End Mills	Высокопроизводительные Концевые Фрезы	280	APMR-XP..	Ball Nose Modular End Mills	Сферические Фрезерные Головки (Крепление под Резьбу)	307
AHFM-WN..	Modular High Feed End Mills	Высокопроизводительные Торцевые Фрезы	281	ASDM-CC..	Disc Milling	Дисковые Трехсторонние Фрезы	372
AHFM-WO..	High Feed End Mills	Высокопроизводительные Концевые Фрезы	281	ASDM-SPGT..	Disc Milling	Дисковые Трехсторонние Фрезы	371
AHFM-YO..	High Feed End Mills	Высокопроизводительные Концевые Фрезы	279	ASTB-..	Swiss Easy Change Tools	Swiss Easy Change Tools	70
AHFM-YP..	High Feed End Mills	Высокопроизводительные Концевые Фрезы	278	ATM..	Thread Milling Tools	Резьбонарезные Фрезы	308
AHFM-YP..	Modular High Feed End Mills	Высокопроизводительные Концевые Фрезы	301	ATM-3BEI..	Thread Milling Tools	Резьбонарезные Фрезы	309
AHFM-JO..	High Feed End Mills	Высокопроизводительные Концевые Фрезы	363	ATM60..	Thread Milling Tools	Резьбонарезные Фрезы	310
AHM ..	Helix Chamfer Milling Tools	Спиральные Фрезы для Снятия Фаски	238	ATSM90-CC..	T Slot Milling	T-Образные Фрезы	369
AHM90-AP..	Helix End Mills	Спиральная Концевая Фреза (Кулурузная Фреза)	311	ATSM90-SP..	T Slot Milling	T-Образные Фрезы	370
AHM90-AP1204.. -H	Helix End Mills	Спиральная Концевая Фреза (Кулурузная Фреза)	310	ATSMR-RD..	T Slot Milling	T-Образные Фрезы	370
AIKT-123..-R/L ..	Internal Grooving Tool Holders	Державки для Обработки Внутренних Канавок	176	ATTB ..	Anti Vibration Tool	Антивибрационная Державка	115
AIKT-151..-R/L ..	Internal Grooving Tool Holders	Державки для Обработки Внутренних Канавок	176	ATTC ..	Anti Vibration Tool	Антивибрационная Державка	116
AIKT-154.91-R/L ..	Internal Grooving Tool Holders	Державки для Обработки Внутренних Канавок	177	ATTC- .. SCLCR/L ..	Anti Vibration Tool	Антивибрационная Державка	116
AIKT-GP-R/L ..	Internal Grooving Tool Holders	Державки для Обработки Внутренних Канавок	181	ATTC- .. SDUCR/L ..	Anti Vibration Tool	Антивибрационная Державка	132
AIKT-HK-R/L ..	Internal Grooving Tool Holders	Державки для Обработки Внутренних Канавок	189	ATTC- .. SVUCR/L ..	Anti Vibration Tool	Антивибрационная Державка	117
AIKT-H-R/L ..	Internal Grooving Tool Holders	Державки для Обработки Внутренних Канавок	174	ATTC- .. TCLNR/L ..	Anti Vibration Tool	Антивибрационная Державка	118
AIKT-HS223-R/L ..	Internal Grooving Tool Holders	Державки для Обработки Внутренних Канавок	175	ATTC- .. TDUNR/L ..	Anti Vibration Tool	Антивибрационная Державка	117
AIKT-IGE-R/L ..	Internal Grooving Tool Holders	Державки для Обработки Внутренних Канавок	178	ATUM .. xD2 KDR ..	U-Drill	Сверла	210
AIKT-IGI-R/L ..	Internal Grooving Tool Holders	Державки для Обработки Внутренних Канавок	179	ATUM .. xD2 SP ..	U-Drill	Сверла	195
AIKT-IG-R/L ..	Internal Grooving Tool Holders	Державки для Обработки Внутренних Канавок	180	ATUM .. xD2 SPGT ..	U-Drill	Сверла	201
AIKT-I-R/L ..	Internal Grooving Tool Holders	Державки для Обработки Внутренних Канавок	179	ATUM .. xD2 WCM ..	U-Drill	Сверла	188
AIKT-ITG-R/L ..	Internal Grooving Tool Holders	Державки для Обработки Внутренних Канавок	180	ATUM .. xD3 KDR ..	U-Drill	Сверла	211
AIKT-KG-R/L ..	Internal Grooving Tool Holders	Державки для Обработки Внутренних Канавок	174	ATUM .. xD3 SO ..	U-Drill	Сверла	208
AIKT-KM-R/L ..	Internal Grooving Tool Holders	Державки для Обработки Внутренних Канавок	175	ATUM .. xD3 SP ..	U-Drill	Сверла	198
AIKT-K-R/L ..	Internal Grooving Tool Holders	Державки для Обработки Внутренних Канавок	173				
AIKT-MB..	Mini Grooving Tool	Мини Державка Для Обработки Внутренних Канавок	183				
AIKT-QC..-R/L ..	Internal Grooving Tool Holders	Державки для Обработки Внутренних Канавок	182				

KOD / CODE	AÇIKLAMA / DESCRIPTION	СОДЕРЖАНИЕ	S.N. / P.N. СТР.	KOD / CODE	AÇIKLAMA / DESCRIPTION	СОДЕРЖАНИЕ	S.N. / P.N. СТР.
ATUM .. xD3 SPGT ..	U-Drill	Сверла	202	PDJNR/L .. -H	External Turning Toolholders With Coolant Tools	Державки для Наружного Точения с подводом СОЖ	35
ATUM .. xD3 WCM ..	U-Drill	Сверла	190	PDNNN ..	External Tool Holders	Державки для Наружного Точения	36
ATUM .. xD4 KDR ..	U-Drill	Сверла	210	PDNNN-H	External Turning Toolholders With Coolant Tools	Державки для Наружного Точения с подводом СОЖ	36
ATUM .. xD4 SO ..	U-Drill	Сверла	209	PDQNR/L ..	Internal Tool Holders	Расточные Державки	90
ATUM .. xD4 SP ..	U-Drill	Сверла	199	PDUNR/L ..	Internal Tool Holders	Расточные Державки	91
ATUM .. xD4 SPGT ..	U-Drill	Сверла	204	PDXNR/L ..	Internal Tool Holders	Расточные Державки	90
ATUM .. xD4 WCM ..	U-Drill	Сверла	192	PSBNR/L ..	External Tool Holders	Державки для Наружного Точения	37
ATUM .. xD5 SP ..	U-Drill	Сверла	200	PSDNN ..	Cartridge	Картриджи	130
ATUM .. xD5 WCM ..	U-Drill	Сверла	194	PSDNN ..	External Tool Holders	Державки для Наружного Точения	37
ATUM xD2 SO ..	U-Drill	Сверла	207	PSKNR/L ..	Cartridge	Картриджи	128
ATUM xD2 SOMT ..	U-Drill	Сверла	212	PSKNR/L ..	External Tool Holders	Державки для Наружного Точения	38
ATUM xD3 880 ..	U-Drill	Сверла	216	PSKNR/L ..	Internal Tool Holders	Расточные Державки	92
ATUM xD3 SO ..	U-Drill	Сверла	208	PSRNR/L ..	Cartridge	Картриджи	129
ATUM xD3 SOMT ..	U-Drill	Сверла	213	PSSNR/L ..	External Tool Holders	Державки для Наружного Точения	38
ATUM xD4 SO ..	U-Drill	Сверла	209	PTFNR/L ..	Cartridge	Картриджи	129
ATUM xD4 SOMT ..	U-Drill	Сверла	214	PTFNR/L ..	External Tool Holders	Державки для Наружного Точения	39
ATUM xD5 SOMT ..	U-Drill	Сверла	215	PTGNR/L ..	External Tool Holders	Державки для Наружного Точения	39
ATUM xD5 SPGT ..	U-Drill	Сверла	204	PTGNR/L ..	Cartridge	Картриджи	129
AVTT..	Screwed Tool Holders	Оправки для Сменных Головок	308	PTJNR/L ..	External Tool Holders	Державки для Наружного Точения	40
CCLNR/L ..	External Tool Holders	Державки для Наружного Точения	45	PTTNR/L ..	External Tool Holders	Державки для Наружного Точения	40
CDJNR/L ..	External Tool Holders	Державки для Наружного Точения	46	PTUNR/L ..	Internal Tool Holders	Расточные Державки	93
CDNNN ..	External Tool Holders	Державки для Наружного Точения	46	PWLNR/L ..	External Tool Holders	Державки для Наружного Точения	41
CKJNR/L ..	External Tool Holders	Державки для Наружного Точения	45	PWLNR/L ..	Internal Tool Holders	Расточные Державки	94
CKUNR/L ..	Internal Tool Holders	Расточные Державки	98	PWLNR/L .. -H	External Turning Toolholders With Coolant Tools	Державка для обработки наружных канавок с подводом СОЖ	41
CRDCN ..	External Tool Holders	Державки для Наружного Точения	47	PDJCR/L .. -H	External Tool Holders Swiss Type	Державки для Наружного Точения Swiss Type	42
CRDCR/L ..	External Tool Holders	Державки для Наружного Точения	48	S/SCLCR/L ..	Boring Bars SET	Наборы Расточных Державок	111
CSDNN ..	External Tool Holders	Державки для Наружного Точения	48	S/SDUCR/L ..	Boring Bars SET	Наборы Расточных Державок	112
CSKNR/L ..	External Tool Holders	Державки для Наружного Точения	49	SCACR/L ..	Engine Overhaul Cartridge	Хонингованные Картриджи	123
CSRNR/L ..	External Tool Holders	Державки для Наружного Точения	49	SCACR/L ..	External Tool Holders	Державки для Наружного Точения	51
CSSNR/L ..	External Tool Holders	Державки для Наружного Точения	50	SCACR/L ..-S	External Tool Holders Swiss Type	Державки для Наружного Точения Swiss Type	66
CTFPR/L ..	Boring Bars	Расточных Державок	82	SCFCR/L	Spare Parts Of Cartridge	Запасные части für Kasette	130
CTJNR/L ..	External Tool Holders	Державки для Наружного Точения	50	SCFCR/L ..	Cartridge	Картриджи	125
E/SCLCR/L ..	Boring Bars SET	Наборы Расточных Державок	111	SCFCR/L ..	Internal Tool Holders	Расточные Державки	97
E/SDUCR/L ..	Boring Bars SET	Наборы Расточных Державок	112	SCLCR/L ..	Boring Bars With Carbide Shank	Расточная державка из Твердосплавного Карбида	109
E/STFCR/L ..	Boring Bars	Расточных Державок	112	SCLCR/L ..	External Tool Holders	External Tool Holders	52
E/STUPR/L ..	Boring Bars	Расточных Державок	110	SCLCR/L ..-SHC	External Tool Holders	External Tool Holders	53
MCLNR/L ..	Internal Tool Holders	Расточные Державки	84	SCLCR/L ..	Internal Tool Holders	Расточные Державки	96
MDUNR/L ..	Internal Tool Holders	Расточные Державки	84	SCLCR/L ..-S	External Tool Holders Swiss Type	Державки для Наружного Точения Swiss Type	66
MTENN ..	External Tool Holders	Державки для Наружного Точения	30	SCMCN ..	Engine Overhaul Cartridge	Хонингованные Картриджи	124
MTFNR/L ..	Internal Tool Holders	Расточные Державки	85	SCMCN ..	External Tool Holders	Державки для Наружного Точения	53
MTJNR/L ..	External Tool Holders	Державки для Наружного Точения	30	SCSCR/L	Spare Parts Of Cartridge	Запасные части für Kasette	130
MT-NR/L ..	Internal Tool Holders	Расточные Державки	85	SCSCR/L ..	Cartridge	Картриджи	126
MTQNR/L ..	Internal Tool Holders	Расточные Державки	86	SDACR/L ..-S	External Tool Holders Swiss Type	Державки для Наружного Точения Swiss Type	67
MTUNR/L ..	Internal Tool Holders	Расточные Державки	86	SD-CR/L ..	Internal Tool Holders	Расточные Державки	97
MWLNR/L ..	External Tool Holders	Державки для Наружного Точения	31	SDHCR/L ..	External Tool Holders	Державки для Наружного Точения	54
MWLNR/L ..	Internal Tool Holders	Расточные Державки	87	SDJCR/L ..	External Tool Holders	Державки для Наружного Точения	54
MWMNN ..	External Tool Holders	Державки для Наружного Точения	31	SDJCR/L ..	Sec Tools	Sec Tools	71
PCBNR/L ..	External Tool Holders	Державки для Наружного Точения	33	SDJCR/L ..-S	External Tool Holders Swiss Type	Державки для Наружного Точения Swiss Type	67
PCLNR/L ..	External Tool Holders	Державки для Наружного Точения	33				
PCLNR/L ..	Internal Tool Holders	Расточные Державки	89				
PCLNR/L ..-H	External Turning Toolholders With Coolant Tools	Державки для Наружного Точения с подводом СОЖ	34				
PCMNN ..	External Tool Holders	Державки для Наружного Точения	34				
PDJNR/L ..	External Tool Holders	Державки для Наружного Точения	35				

KOD / CODE	AÇIKLAMA / DESCRIPTION	СОДЕРЖАНИЕ	S.N. / P.N. СТР.
SDJCR/L ..-SHC	External Tool Holders	Державки для Наружного Точения	55
SDJCR/L ..	Swiss Easy Change Tools	Swiss Easy Change Tools	71
SDNCN ..	External Tool Holders	Державки для Наружного Точения	55
SDPCR/L ..	Internal Tool Holders	Расточные Державки	98
SDQCR/L ..	Internal Tool Holders	Расточные Державки	98
SDUCR/L ..	Boring Bars With Carbide Shank	Bohrstangen mit Hartmetallschaft	109
SDUCR/L ..	Internal Tool Holders	Расточные Державки	99
SDXCR/L ..	Internal Tool Holders	Расточные Державки	100
SER/L ..	External Threading Tool Holders	Державка для Нарезания Наружной Резьбы	134
SER/L ..	Sec Tools	Sec Tools	72
SIR/L ..	Internal Threading Tool Holders	Державка для Нарезания Внутренней Резьбы	135
SRDCN ..	External Tool Holders	Державки для Наружного Точения	56
SRDCR/L ..	External Tool Holders	Державки для Наружного Точения	57
SRGCR/L ..	External Tool Holders	Державки для Наружного Точения	57
SRGCR/L ..	Internal Tool Holders	Расточные Державки	101
SRHCR/L ..	External Tool Holders	Державки для Наружного Точения	58
SRSCN..	Engine Overhaul Cartridge	Motorüberholungskassette	124
SRXCR/L ..	External Tool Holders	Державки для Наружного Точения	58
SSDCN ..	External Tool Holders	Державки для Наружного Точения	59
SSKCR/L ..	Cartridge	Картриджи	126
SSSCR/L ..	External Tool Holders	Державки для Наружного Точения	59
SSSCR/L ..	Internal Tool Holders	Расточные Державки	101
STCCN ..	External Tool Holders	Державки для Наружного Точения	61
ST-CR/L ..	Internal Tool Holders	Расточные Державки	102
STFCR/L	Spare Parts Of Cartridge	Запасные части für Kassette	130
STFCR/L ..	Cartridge	Картриджи	127
STFCR/L ..	External Tool Holders	Державки для Наружного Точения	60
STFCR/L ..	Internal Tool Holders	Расточные Державки	102
STFPR/L ..	Finish Boring Heads Cartridge	КАРТРИДЖИ РЕГУЛИРУЕМОЙ РАСТОЧНОЙ ГОЛОВКИ ДЛЯ ЧИСТОВОГО ТОЧЕНИЯ	229
STGCR/L ..	External Tool Holders	Державки для Наружного Точения	60
STGCR/L ..-S	External Tool Holders Swiss Type	Державки для Наружного Точения Swiss Type	68
STJCR/L ..	External Tool Holders	Державки для Наружного Точения	61
STSCR/L	Spare Parts Of Cartridge	Запасные части für Kassette	130
STSCR/L ..	Cartridge	Картриджи	127
STTCR/L	Spare Parts Of Cartridge	Запасные части für Kassette	130
STTCR/L ..	Cartridge	Картриджи	128
STUCR/L ..	External Tool Holders	Державки для Наружного Точения	62
STUCR/L ..	Internal Tool Holders	Расточные Державки	103
STUPR/L ..	Internal Tool Holders	Расточные Державки	104
STUPR/L ..	Finish Boring Heads Cartridge	КАРТРИДЖИ РЕГУЛИРУЕМОЙ РАСТОЧНОЙ ГОЛОВКИ ДЛЯ ЧИСТОВОГО ТОЧЕНИЯ	228
STXCR/L ..	Engine Overhaul Cartridge	Motorüberholungskassette	125
SVACR/L ..-S	External Tool Holders Swiss Type	Державки для Наружного Точения Swiss Type	69
SVHBR/L ..	External Tool Holders	Державки для Наружного Точения	62
SVHCR/L ..	External Tool Holders	Державки для Наружного Точения	63
SVJBR/L ..	External Tool Holders	Державки для Наружного Точения	63
SVJBR/L ..	Internal Tool Holders	Расточные Державки	104

KOD / CODE	AÇIKLAMA / DESCRIPTION	СОДЕРЖАНИЕ	S.N. / P.N. СТР.
SVJBR/L ..-S	External Tool Holders Swiss Type	Державки для Наружного Точения Swiss Type	69
SVJCR/L	Swiss Easy Change Tools	Swiss Easy Change Tools	71
SVJCR/L ..	External Tool Holders	Державки для Наружного Точения	64
SVJCR/L ..	Internal Tool Holders	Расточные Державки	107
SVJCR/L ..	Sec Tools	Sec Tools	71
SVJCR/L ..-S	External Tool Holders Swiss Type	Державки для Наружного Точения Swiss Type	70
SVQBR/L ..	Internal Tool Holders	Расточные Державки	105
SVQCR/L ..	Internal Tool Holders	Расточные Державки	105
SVUBR/L ..	Internal Tool Holders	Расточные Державки	106
SVUCR/L ..	Internal Tool Holders	Расточные Державки	106
SVVBN ..	External Tool Holders	Державки для Наружного Точения	65
SVVCN ..	External Tool Holders	Державки для Наружного Точения	65
SVXBR/L ..	Internal Tool Holders	Расточные Державки	107
SVJCR/L ..-SHC	External Tool Holders	Державки для Наружного Точения	64
SWLCR ..	Internal Tool Holders	Расточные Державки	108
SWLCR ..	Finish Boring Heads Cartridge	КАРТРИДЖИ РЕГУЛИРУЕМОЙ РАСТОЧНОЙ ГОЛОВКИ ДЛЯ ЧИСТОВОГО ТОЧЕНИЯ	228
SWUBR ..	Internal Tool Holders	Расточные Державки	108
TCBNR/L ..	External Tool Holders	Державки для Наружного Точения	13
TCBNR/L ..-H	External Tool Holders	Державки для Наружного Точения	13
TCKNR/L ..	External Tool Holders	Державки для Наружного Точения	14
TCKNR/L ..-H	External Tool Holders	Державки для Наружного Точения	14
TCLNR/L ..	External Tool Holders	Державки для Наружного Точения	15
TCLNR/L ..-H	External Tool Holders	Державки для Наружного Точения	15
TCLNR/L ..	Internal Tool Holders	Расточные Державки	77
TCLNR/L .. -H	External Turning Toolholders With Coolant Tools	Державки для Наружного Точения с подводом СОЖ	15
TCMNN ..	External Tool Holders	Державки для Наружного Точения	16
TCZNN ..	External Tool Holders	Державки для Наружного Точения	16
TDHNR/L ..	External Tool Holders	Державки для Наружного Точения	17
TDJNR/L ..	External Tool Holders	Державки для Наружного Точения	17
TDJNR/L .. -H	External Turning Toolholders With Coolant Tools	Державки для Наружного Точения с подводом СОЖ	18
TDNNN ..	External Tool Holders	Державки для Наружного Точения	18
TDNNN-H	External Turning Toolholders With Coolant Tools	Державки для Наружного Точения с подводом СОЖ	19
TD-NR/L ..	Internal Tool Holders	Расточные Державки	77
TDQNR/L ..	Internal Tool Holders	Расточные Державки	78
TDUNR/L ..	Internal Tool Holders	Расточные Державки	78
TER/L ..	External Threading Tool Holders	Державка для Нарезания Наружной Резьбы	136
TER/L ..	Sec Tools	Sec Tools	72
TIR/L ..	Internal Threading Tool Holders	Державка для Нарезания Внутренней Резьбы	137
TSDNN ..	External Tool Holders	Державки для Наружного Точения	19
TSDNN ..-H	External Tool Holders	Державки для Наружного Точения	20
TSKNR/L ..	External Tool Holders	Державки для Наружного Точения	20
TSKNR/L ..	Internal Tool Holders	Расточные Державки	79
TSSNR/L ..	External Tool Holders	Державки для Наружного Точения	21
TSSNR/L .. -H	External Tool Holders	Державки для Наружного Точения	21
TTENN ..	External Tool Holders	Державки для Наружного Точения	22
TTGNR/L ..	External Tool Holders	Державки для Наружного Точения	22

KOD / CODE	AÇIKLAMA / DESCRIPTION	СОДЕРЖАНИЕ	S.N. / P.N. СТР.
TTJNR/L ..	External Tool Holders	Державки для Наружного Точения	23
TTJNR/L .. -H	External Tool Holders	Державки для Наружного Точения	23
TT-NR/L ..	Internal Tool Holders	Расточные Державки	79
TTUNR/L ..	Internal Tool Holders	Расточные Державки	80
TVHNR/L ..	External Tool Holders	Державки для Наружного Точения	24
TVJNR/L ..	External Tool Holders	Державки для Наружного Точения	24
TVJNR/L ..-H	External Tool Holders	Державки для Наружного Точения	25
TVUNR/L ..	Internal Tool Holders	Расточные Державки	80
TVVNN ..	External Tool Holders	Державки для Наружного Точения	25
TVVNN .. -H	External Tool Holders	Державки для Наружного Точения	26
TWLNR/L ..	External Tool Holders	Державки для Наружного Точения	26
TWLNR/L ..	Internal Tool Holders	Расточные Державки	81
TWLNR/L .. -H	External Turning Toolholders With Coolant Tools	Державки для Наружного Точения с подводом СОЖ	27
AACN-..	Spare Parts	Запасные части	380
AADN-..	Spare Parts	Запасные части	380
AAL-..	Spare Parts	Запасные части	380
AARC-..	Spare Parts	Запасные части	380
AASD-..	Spare Parts	Запасные части	380
AASE-..	Spare Parts	Запасные части	380
AASN-..	Spare Parts	Запасные части	380
AATN-..	Spare Parts	Запасные части	380
AAV-..	Spare Parts	Запасные части	380
AAVN-..	Spare Parts	Запасные части	380
AAWN-..	Spare Parts	Запасные части	380
AAV-..	Spare Parts	Запасные части	386
ABK-..	Spare Parts	Запасные части	393
ABKS-..	Spare Parts	Запасные части	392
ABPL-..	Spare Parts	Запасные части	392
ACK-..	Spare Parts	Запасные части	381
ACS-..	Spare Parts	Запасные части	391
AEV-..	Spare Parts	Запасные части	387
AKS-..	Spare Parts	Запасные части	380
AKV-..	Spare Parts	Запасные части	382-383-384-385
AKY-..	Spare Parts	Запасные части	384
ALA-..	Spare Parts	Запасные части	393
ALV-..	Spare Parts	Запасные части	385
AMK-..	Spare Parts	Запасные части	381
AN-01..	Spare Parts	Запасные части	382
AOR-01	Spare Parts	Запасные части	392
APL-..	Spare Parts	Запасные части	385
APM-..	Spare Parts	Запасные части	386
AS-01	Spare Parts	Запасные части	391
ATK-..	Spare Parts	Запасные части	381
ATKH-..	Spare Parts	Запасные части	381
ATS-..	Spare Parts	Запасные части	380
AXR-01	Spare Parts	Запасные части	392
1008-..	Spare Parts	Запасные части	388
1015-..	Spare Parts	Запасные части	388
1020-..	Spare Parts	Запасные части	389
1108-..	Spare Parts	Запасные части	388
1120-..	Spare Parts	Запасные части	389
1204-..	Spare Parts	Запасные части	387
1208-..	Spare Parts	Запасные части	387

KOD / CODE	AÇIKLAMA / DESCRIPTION	СОДЕРЖАНИЕ	S.N. / P.N. СТР.
1210-..	Spare Parts	Запасные части	387
1215-..	Spare Parts	Запасные части	387
1220-..	Spare Parts	Запасные части	387
1315-..	Spare Parts	Запасные части	388
1415-..	Spare Parts	Запасные части	389
1420-..	Spare Parts	Запасные части	389
1510-..	Spare Parts	Запасные части	388
1515-..	Spare Parts	Запасные части	389
1520-..	Spare Parts	Запасные части	389
1615-..	Spare Parts	Запасные части	389
1620-..	Spare Parts	Запасные части	389
1707-..	Spare Parts	Запасные части	389
1710-..	Spare Parts	Запасные части	389
1720-..	Spare Parts	Запасные части	389
1904-..	Spare Parts	Запасные части	385
2004-..	Spare Parts	Запасные части	385
2306-..	Spare Parts	Запасные части	391
2405-..	Spare Parts	Запасные части	391
2406-..	Spare Parts	Запасные части	391
2407-..	Spare Parts	Запасные части	391
2408-..	Spare Parts	Запасные части	391
2503-..	Spare Parts	Запасные части	391
2504-..	Spare Parts	Запасные части	391
2505-..	Spare Parts	Запасные части	391
2506-..	Spare Parts	Запасные части	391
2508-..	Spare Parts	Запасные части	391
2510-..	Spare Parts	Запасные части	391
2514-..	Spare Parts	Запасные части	391
2525-..	Spare Parts	Запасные части	391
2600-..	Spare Parts	Запасные части	390
2702-..	Spare Parts	Запасные части	390
2703-..	Spare Parts	Запасные части	390
2704-..	Spare Parts	Запасные части	390
2705-..	Spare Parts	Запасные части	390
2715-..	Spare Parts	Запасные части	390
2725-..	Spare Parts	Запасные части	390
3006-..	Spare Parts	Запасные части	388
3007-..	Spare Parts	Запасные части	388
3008-..	Spare Parts	Запасные части	388
3010-..	Spare Parts	Запасные части	388
3015-..	Spare Parts	Запасные части	388
3108-..	Spare Parts	Запасные части	388
4006-..	Spare Parts	Запасные части	388
4008-..	Spare Parts	Запасные части	388
4010-..	Spare Parts	Запасные части	388
4015-..	Spare Parts	Запасные части	388
4020-..	Spare Parts	Запасные части	389
4108-..	Spare Parts	Запасные части	388
4115-..	Spare Parts	Запасные части	389
4420-..	Spare Parts	Запасные части	389
4515-..	Spare Parts	Запасные части	389
4615-..	Spare Parts	Запасные части	389
80-..	Spare Parts	Запасные части	393
81-..	Spare Parts	Запасные части	396



konusulan
the spoken kalite...
quality...



www.akko.com.tr



konusulan
the spoken **kalite...**
quality...





SKYCOAT
APM...
XPH... 20R10T3

SKYCOAT
ACM45-SP-140S-D4
SP-140S
1020-M5X11

SKYCOAT
AEM90-XN-04-02
XEM 0403-4008-M2X3



